

User Manual

K-BUS® KNX Presence Sensor Series_V1.4

CSBP-04/00.1.00

CSBPM-04/00.1.00



KNX/EIB Home and Building Control System

Attentions

1. Please keep devices away from strong magnetic field, high temperature, wet environment;

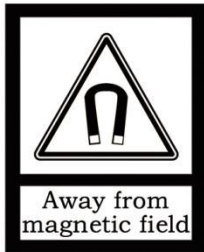

2. Do not fall the device to the ground or make them get hard impact;



3. Do not use wet cloth or volatile reagent to wipe the device;



4. Do not disassemble the devices.

Contents

Chapter 1 Summary	1
Chapter 2 Technical Data	2
2.1. CSBPM-04/00.1.00	2
2.2. CSBP-04/00.1.00	3
Chapter 3 Dimension and Structural Diagram	4
3.1. Dimension Diagram	4
3.2. Structural Diagram	4
3.3. Installation Diagram	5
3.3.1. CSBPM-04/00.1.00	5
3.3.2. CSBP-04/00.1.00	6
Chapter 4 Project Design and Programming	7
Chapter 5 Parameter setting description in the ETS	10
5.1. KNX Secure	10
5.2. Parameter window "General"	14
5.2.1. Parameter window "General setting"	14
5.2.2. Parameter window "Advanced setting"	16
5.3. Parameter window "Internal sensor measurement"	17
5.4. Parameter window "Presence function"	22
5.4.1. Parameter window "Presence control x"	22
5.5. Parameter window "Light control"	37
5.5.1. Parameter window "Output"	39
5.6. Parameter window "Constant lighting"	42
5.6.1. Parameter window "Output"	44
5.6.2. Parameter window "Main-Sub operation"	50
5.7. Parameter window "RTC function"	52
5.7.1. Parameter window "Setpoint"	59
5.7.2. Parameter window "Heating/Cooling control"	65
5.7.3. Parameter window "Fan auto.control"	73
5.8. Parameter window "Logic"	77
5.8.1. Parameter window "AND/OR/XOR"	78
5.8.2. Parameter window "Gate forwarding"	80
5.8.3. Parameter window "Threshold comparator"	81
5.8.4. Parameter window "Format convert"	83
5.8.5. Parameter window "Gate function"	84
5.8.6. Parameter window "Delay function"	85
5.8.7. Parameter window "Staircase lighting"	86
5.9. Parameter window "Scene Group function"	87
Chapter 6 Description of Communication Object	89
6.1. "General" Communication Object	89
6.2. "Internal sensor measurement" Communication Object	90

6.3. "Presence function" Communication Object	91
6.4. "Light control" Communication Object	94
6.5. "Constant lighting" Communication Object	95
6.6. "RTC function" Communication Object	97
6.7. "Logic function" Communication Object	102
6.7.1. "AND/OR/XOR" Communication Object	102
6.7.2. "Gate forwarding" Communication Object	102
6.7.3. "Threshold comparator" Communication Object	103
6.7.4. "Format convert" Communication Object	104
6.7.5. "Gate function" Communication Object	106
6.7.6. "Delay function" Communication Object	107
6.7.7. "Staircase lighting" Communication Object	108
6.8. "Scene Group" Communication Object	109

Chapter 1 Summary

KNX presence sensor series includes **KNX Presence Sensor,Microwave** (CSBPM-04/00.1.00) that uses 24GHz microwave detection technology, and **KNX Motion Sensor,PIR** (CSBP-04/00.1.00) which uses pyroelectric infrared detection technology. Both built in presence sensor and brightness sensor which are used for illumination or occasions where presence/motion is required (office, hotel, home and etc.). Brightness sensor measures the current brightness, support to light control and constant lighting function, and the brightness and presence detector can be flexibly combined control. Besides, this series of products also supports to temperature sensor, humidity sensor, RTC function, logic function and scene group function, can meet more complex and diverse control and applications.

This manual provides specific technical information about KNX presence sensor series product for users, as well as assembly and programming details, and explains how to use the sensor by the application examples.

KNX Presence Sensor,Microwave is connected to KNX bus, and need a 12-30V DC auxiliary supply voltage, but **KNX Motion Sensor,PIR** is only powered from the bus. It is available to assign the physical address and configure the parameters by engineering design tools ETS with .knxprod (support edition ETS5.7 or higher).

Functions are summarized as followed:

- **Different behavioral detection of normal movement, tiny movement and static presence, with 24GHz microwave detection technology (Apply to CSBPM-04/00.1.00)**
- **Behavioral detection of obvious movement with pyroelectric infrared detection technology (Apply to CSBP-04/00.1.00)**
- **Sensitivity is configurable and can be adjusted by day/night (Apply to CSBPM-04/00.1.00)**
- **Work modes of master/slave**
- **Up to 4 presence control channels, and the first channel with 3 levels control**
- **Automatic mode and semi-automatic mode**
- **Internal brightness sensor, and control the light via brightness threshold and also control logically with presence signal**
- **Individual presence control telegram according to Day/Night**
- **Built-in temperature and humidity sensors**
- **Constant lighting control**
- **RTC functions for heating/cooling system, as well as support additional heating/cooling**
- **Logic functions and scene group functions**
- **Support the KNX Data Secure**

Chapter 2 Technical Data

2.1.CSBPM-04/00.1.00

Power Supply	Bus voltage	21-30V DC, via the KNX bus
	Bus current	<4.5mA / 24V; <4mA / 30V
	Bus consumption	<120mW
Auxiliary supply	Voltage	12-30V DC
	Current	<24.5mA / 24V; <20mA / 30V
	Consumption	<0.6W
Detection range	Illuminance	0-2000lux
	Temperature	0-40°C
	Humidity	20-90%
Connection	KNX	Bus connection terminal
	Auxiliary supply	KNX auxiliary connection terminal
Operation and display	Programming button and red LED	For assigning the physical address
	Green LED flashing	Display the device running normally
Temperature	Operation	- 5 °C ... + 45 °C
	Storage	- 25 °C ... + 55 °C
	Transport	- 25 °C ... + 70 °C
Environment	Humidity	<93%, except dewing
Mounting	Ceiling mounted	
Dimension	φ65 x 38 mm	
Weight	0.05kg	

2.2.CSBP-04/00.1.00

Power Supply	Bus voltage	21-30V DC, via the KNX bus
	Bus current	<6.5mA / 24V; <5.5mA / 30V
	Bus consumption	<165mW
Detection range	Illuminance	0-2000lux
	Temperature	0-40°C
	Humidity	20-90%
Connection	KNX	Bus connection terminal
Operation and display	Programming button and red LED	For assigning the physical address
	Green LED flashing	Display the device running normally
Temperature	Operation	- 5 °C ... + 45 °C
	Storage	- 25 °C ... + 55 °C
	Transport	- 25 °C ... + 70 °C
Environment	Humidity	<93%, except dewing
Mounting	Ceiling mounted, Flush mounted in 80 mm or 86mm box	
	Flush mounted with additional accessory CSPFA-86/0.1.0x	
Dimension	φ70 x 51.5mm	
Weight	0.05kg	

Chapter 3 Dimension and Structural Diagram

3.1. Dimension Diagram

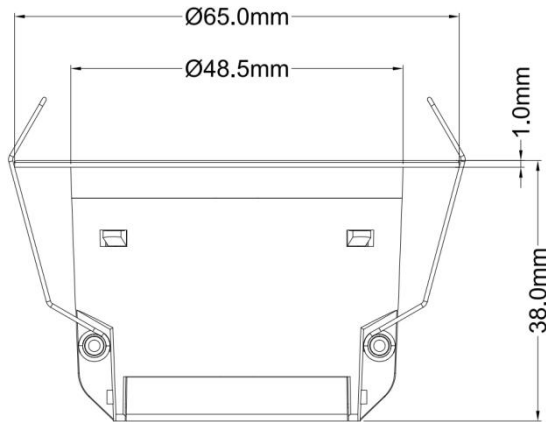

CSBPM-04/00.1.00

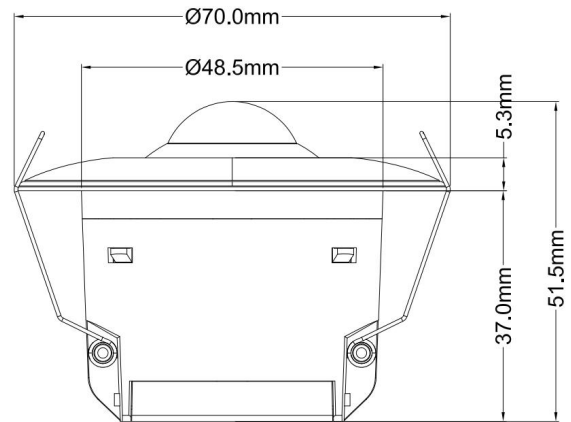

CSBP-04/00.1.00

3.2. Structural Diagram

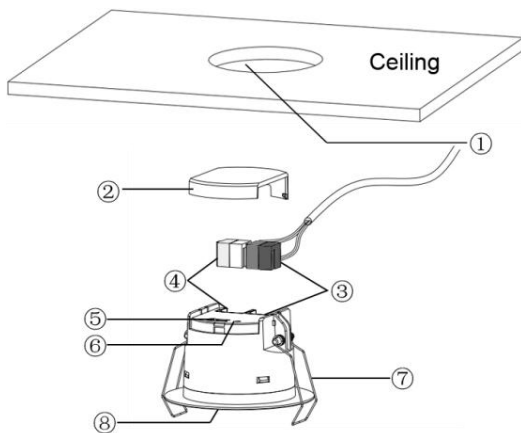

CSBPM-04/00.1.00

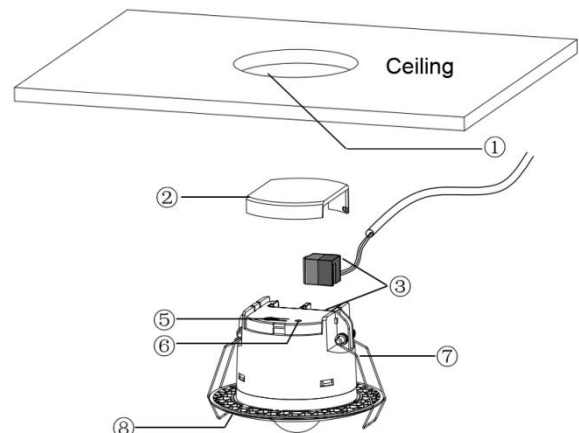

CSBP-04/00.1.00

- ① Install hole($\phi 53\text{mm}$ / $\phi 55\text{mm}$)
- ② Protection cover
- ③ KNX bus connection terminal
- ④ Auxiliary supply connection terminal
- ⑤ Programming button
- ⑥ Programming LED
- ⑦ Install spring
- ⑧ Sensor cover

Reset the device to the factory configuration: press the programming button and hold for 4 seconds then release, repeat the operation for 4 times, and the interval between each operation is less than 3 seconds

3.3. Installation Diagram

3.3.1. CSBPM-04/00.1.00

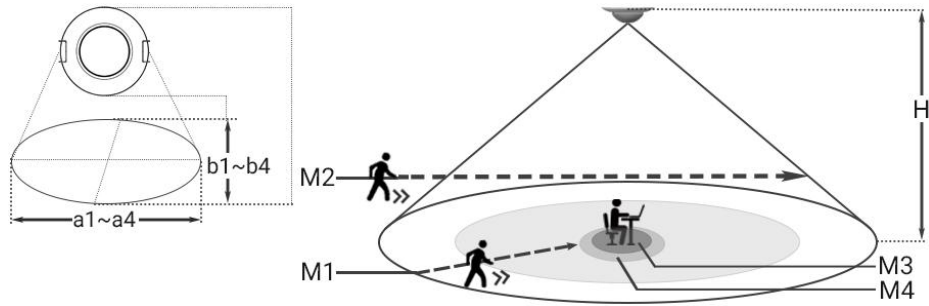

Installation diagram of CSBPM-04/00.1.00

H	M1		M2		M3		M4	
	a1	b1	a2	b2	a3	b3	a4	b4
2.5	6	5	7	5.5	6.5	5	6.5	6
3	7	6.5	8	7.5	7.5	6	8	6
4	8.5	7.5	8.3	8.5	8.5	7.5	8.5	7.5

The Installation height is 3m:

Sensitivity	S1	S2	M3	M4
Lowest	2.8	2.5	3.5	4.5
Low	3.5	3	4	5.2
Medium	5	4	5	6.5
High	6	5	6	7
Highest	7	6	7.5	8

Above table shows the maximum range of the different areas for different installation heights (H) or sensitivity (**unit: meter**):

a: the wide range of detection diameter; b: the narrow range of detection diameter; **a, b is corresponds to direction of sensor installation**

M1: walking straight to sensor; M2: walking across sensor; M3: tiny movement;

M4: static presence; S1: walk slowly, 0.3m/s; S2: walk fast, 1.0m/s.

Note: the data is referred from internal laboratory, there may be differences in results depending on the environment and object.

3.3.2. CSBP-04/00.1.00

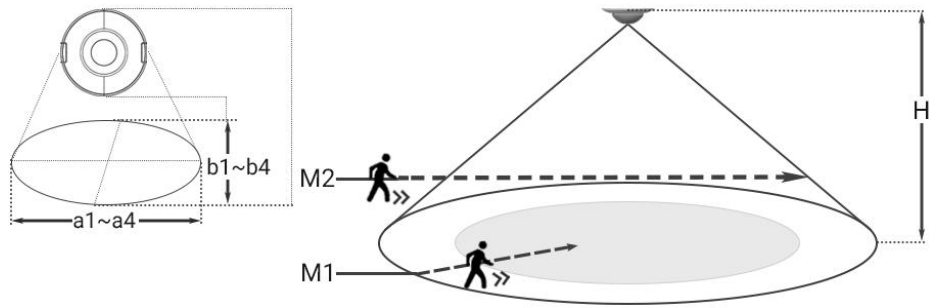

Installation diagram of CSBP-04/00.1.00

H	M1		M2	
	a1	b1	a2	b2
2.5	5	4	7	6
3	6	5	8	7
4	8	7	11	9.5
5	10	8.5	13.5	11.5
6	11	10	15.5	13.5

Above table shows the maximum range of the different areas for different installation heights (H) (**unit: meter**):

a: the wide range of detection diameter; b: the narrow range of detection diameter; **a, b is corresponds to direction of sensor installation**

M1: walking straight to sensor; M2: walking across sensor.

Note: the data is referred from internal laboratory, there may be differences in results depending on the environment and object.

For better detection effect, temperature difference between the ambient and the human body should be greater than 5°C, to avoid abnormal triggering.

Chapter 4 Project Design and Programming

Application	Maximum of communication objects	Maximum number of group addresses	Maximum number of associations	Secure group addresses
KNX Presence Sensor,Microwave/1.2 KNX Motion Sensor,PIR/1.2	276	500	500	339

General function

General function includes device In operation setting, night mode enabled. In addition, **KNX Presence Sensor,Microwave** supports setting presence sensitivity and the reference of behavior detection.

Temperature and humidity measurement

Internal temperature and humidity measurement value is sent to the bus: respond after read only and respond after change.

Send alarm telegram when the preset range of threshold value for temperature / humidity alarm is exceeded.

Brightness measurement

Internal brightness measurement value is sent to the bus: respond after read only and respond after change.

Set brightness calibration via parameters, support to be updated via bus and overwrite during download.

Presence control function

Up to set 4 presence controls.

Support 2 types of output: Master mode, slave mode.

Support to disable function for presence control, control via object and the object telegrams is optional, the output behavior is set by parameter.

Begin of presence and End of presence send telegrams independently, support to send the last telegram cyclically, up to send 3 output values (Begin is A/B/C, End is D/E/F), thus, 3 levels of lighting control can be achieved. You can set output values for day and night respectively when night mode is

enabled.

Support to 2 operation modes: Automatic mode (Begin of presence and End of presence are both dependent on the sensor), Semi-automatic mode (Begin of presence is triggered by external input, End of presence is dependent on the sensor or external input).

Support presence control depending on brightness, control via object and the object telegrams is optional.

Brightness control

Support to disable function for brightness control , control via object and the object telegrams is optional

The reference of brightness is optional internal, external, proportional mixing internal+external, the mixing data is fed back to bus. The external brightness is optional 1~3.

Support to set the lower and upper thresholds to be compared with brightness, then send the telegram, which can be applied to turn on/off light or recall scene. The threshold behaviour is optional with hysteresis or without hysteresis. When with hysteresis, it is as a buffer area between lower and upper threshold, in which brightness is no action.

Constant lighting

The reference of brightness is optional internal, external, proportional mixing internal+external, the mixing data is fed back to bus. The external brightness is optional 1~3.

Trigger controller on/off via external presence sensor or local presence sensor, send telegram after controller status is changed.

When controller is on, main output brightness support to 3 settings: Specified via parameter, The output is calculated based on a comparison of the current brightness and setpoint, Read the value obtained via request actuator status. You can set output values for day and night respectively when night mode is enabled.

Support to 2 control method: Calculating via proportional, Calculating via offsets. Up to set 4 sub groups. When via proportional, output sub brightness is dependent on the influence of proportional for sub to the main; when via offsets, output sub brightness is dependent on the offset for sub to the main.

Support to set hysteresis value for the main output brightness (Hysteresis value = Setpoint × Hysteresis percent), compare current brightness and “Setpoint ± Hysteresis value” to change brightness and keep output.

When the output is the minimum brightness value and is greater than “Setpoint ± Hysteresis value”,

controller will be in standby mode, output OFF and brightness 0%; when delay time for standby is 0, controller will be always in activation status, output the minimum brightness value. If the current brightness value is lower than “Setpoint - hysteresis - additional hysteresis”, restart controller from standby mode.

Support to stop function. When it is necessary to stop the constant lighting control, manually send the control command to interrupt via other devices (such as button panels, dimmers), the controller will be inactive after receiving the command. After stopping, you can also set a delay to activate the controller automatically.

RTC function

RTC is mainly used to control the room temperature, automatically and optimally control the heating and cooling according to the use of the room or the needs of the occupants.

Support manually switching of heating/cooling control, support options for three-level fan speed and auto fan speed, four operation modes: comfort, standby, economy and protection mode. Linkage control with window contact input detection and presence sensor detection. As well as support additional heating/cooling, to speed up the response of temperature control.

The setting temperature supports absolute and relative settings, as well as adjustable temperature range settings. Supports 2-point and PI control.

Logic function

Up to support 8 channels of logic, each channel up to support 8 inputs and 1 logic result.

Logic function support functions, including AND, OR, XOR, Gate forwarding, Threshold comparator, Format convert, Gate function, Delay function and Staircase lighting.

Scene group function

Up to support 8 channels of scene group forward, each group up to support 8 configurable output, datatype is optional 1bit/1byte/2byte.

Chapter 5 Parameter setting description in the ETS

5.1.KNX Secure

KNX presence sensor series product is a KNX device that complies with the KNX secure standard. That is, you can run the device in safe way.



Fig.5.1 (1) “KNX Secure” parameter window

The device with KNX secure will be displayed notes on ETS, as shown as Fig.5.1(1).

If secure commissioning is activated in ETS project, the following information must be considered during device debugging:



- ❖ It is essential to assign a project password as soon as a KNX Secure device is imported into a project. This will protect the project against unauthorized access.

The password must be kept in a safe place – access to the project is not possible without it (not even the KNX Association or device manufacturer will be able to access it)!

Without the project password, the commissioning key will not be able to be imported.

- ❖ A commissioning key is required when commissioning a KNX Secure device (first download). This key (FDSK = Factory Default Setup Key) is included on a sticker on the side of the device, and it must be imported into the ETS prior to the first download:

- ❖ On the first download of the device, a window pops up in the ETS to prompt the user to enter the key, as shown in Fig.5.1 (2) below.

The certificate can also be read from the device using a QR scanner (recommended).

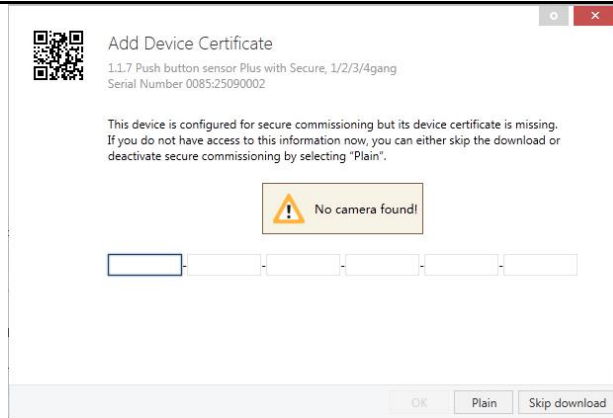

Fig.5.1(2) Add Device Certificate window

- ✧ Alternatively, the certificates of all Secure devices can be entered in the ETS beforehand.

This is done on the “Security” tab on the project overview page, as shown in Fig.5.1(3) below.

The certificates can be also added to the selected device in the project, as shown in

Fig.5.1(4).

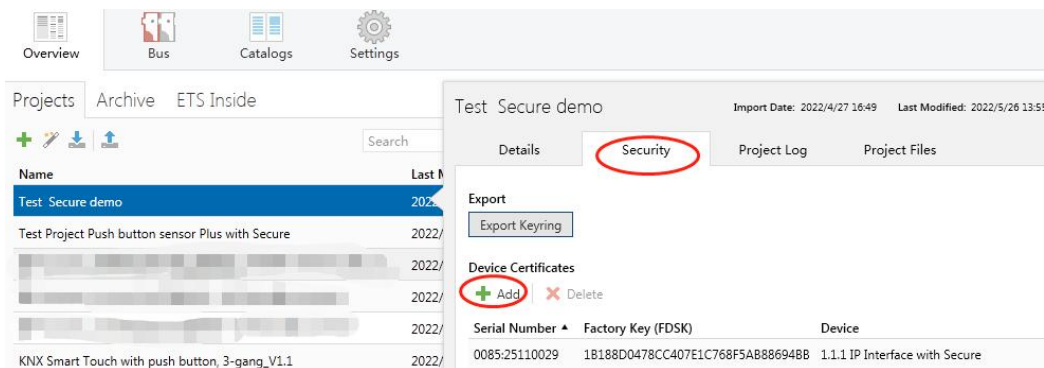

Fig.5.1(3) Add Device Certificate

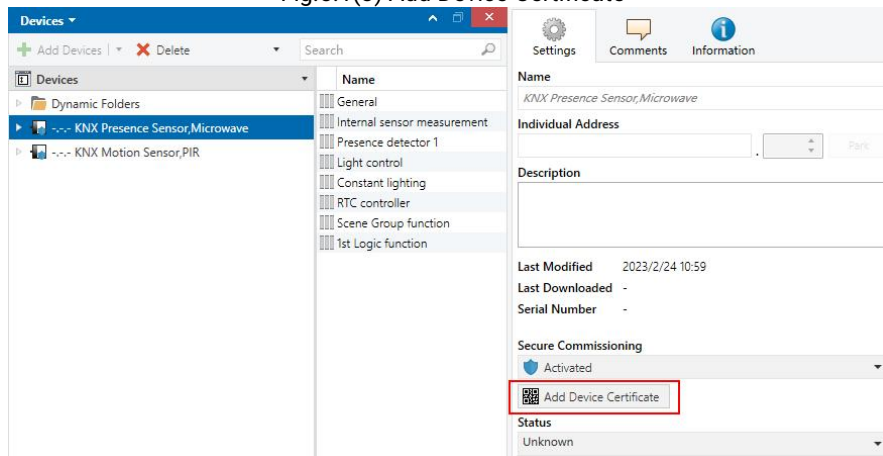

Fig.5.1(4) Add Device Certificate

- ✧ There is a FDSK sticker on the device, which is used for viewing FDSK number.

Without the FDSK, it will no longer be possible to operate the device in KNX Secure mode after a reset.

The FDSK is required only for initial commissioning. After entering the initial FDSK, the ETS will assign a new key, as shown in Fig.5.1(5) below.

The FDSK will be required again only if the device was reset to its factory settings (e.g. If the device is to be used in a different ETS project).

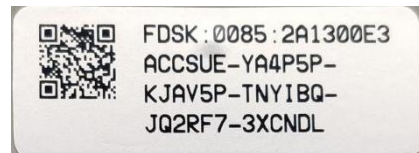
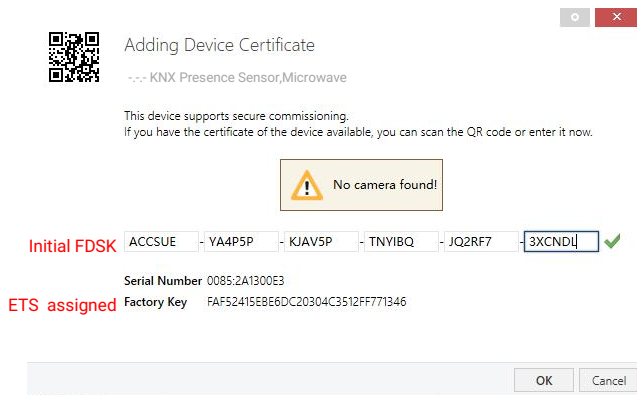

Fig.5.1(5)

Example:

If this application in the project needs to be tried with another device, it is no longer the original device. When the application is downloaded to a new device, the following prompt will appear on the left of Fig.5.1(6), click yes, the Add Device Certificate window will appear, then enter the initial FDSK of the new device, and you need to reset the device to the factory settings (it is not required if the device is still factory default; If it has been used, it will be required to reset, otherwise the following error message will appear on the right of Fig.5.1(6)), and then the device can be successfully downloaded again.

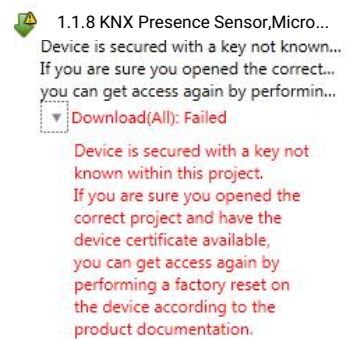
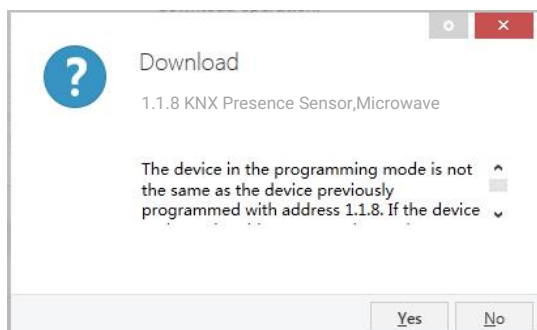

Fig.5.1(6) Example

Whether the device is replaced in the same project, or the device is replaced in a different project, the processing is similar: **Reset the device to the factory settings, then reassign the FDSK.**

After the device is downloaded successfully, the label Add Device Certificate turns gray, indicating that the key for this device has been assigned successfully, as shown in Fig.5.1(7) below.

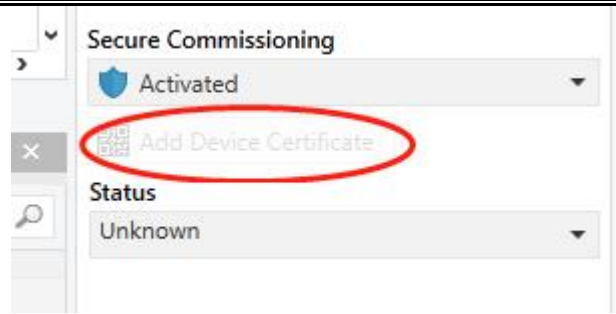

Fig.5.1(7)

ETS generates and manages keys:

Keys and passwords can be exported as needed to the use of security keys outside of the associated ETS projects. As shown in Fig.5.1(8) below, the file extension is .knxkeys.

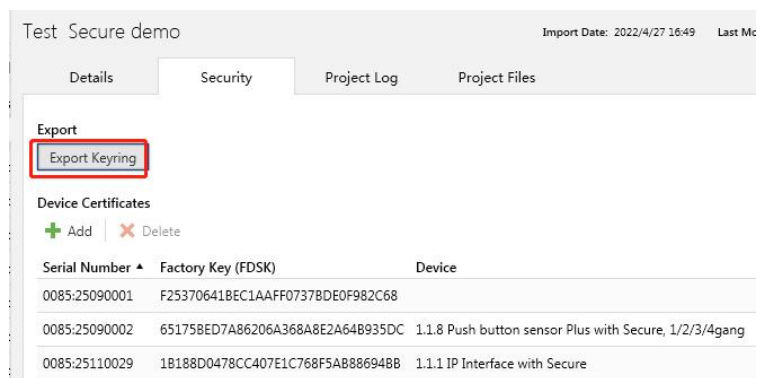

Fig.5.1(8)

Note: Any USB interface used for programming a KNX Secure device must support “long frames”. Otherwise ETS will report a download failure information, as shown below.

5.2. Parameter window “General”

5.2.1. Parameter window “General setting”

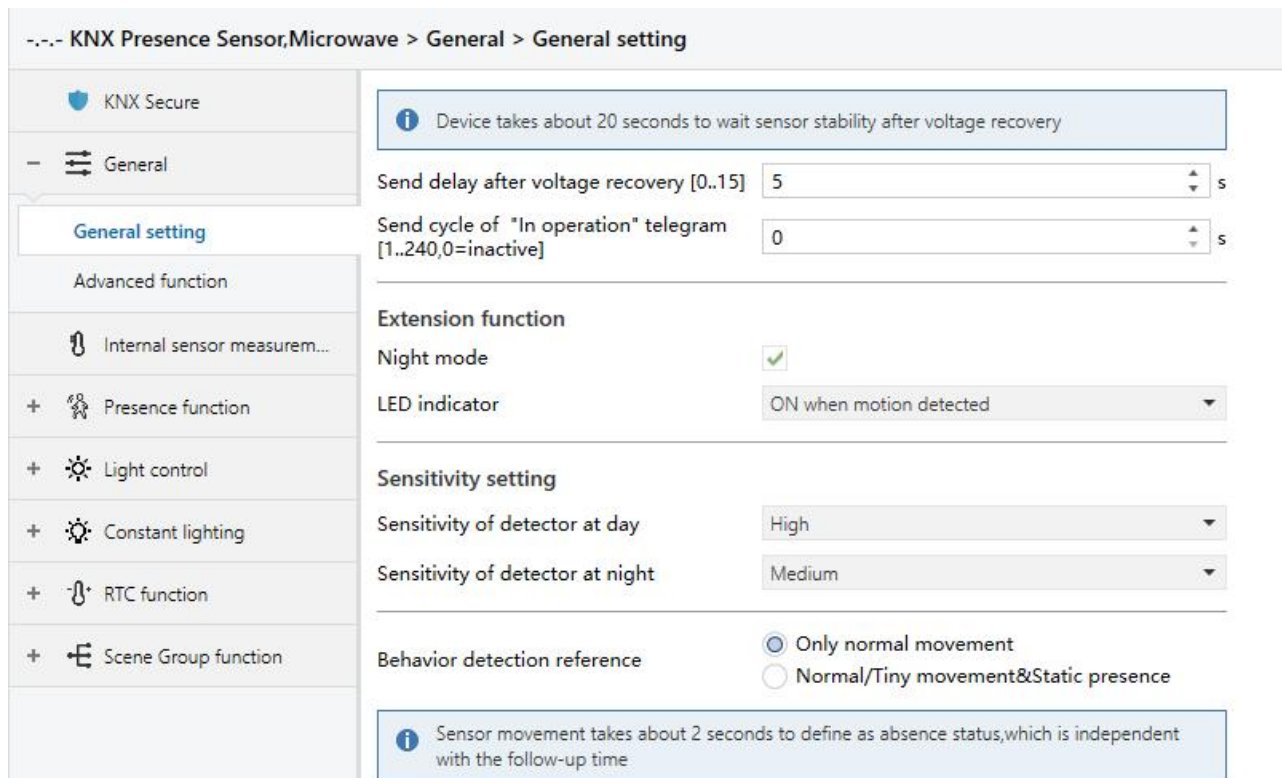
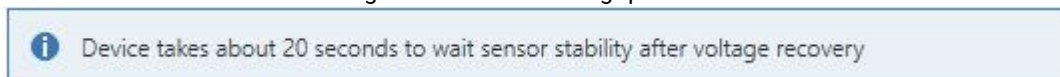

Fig.5.2.1 “General setting” parameter window



Note: there is no any presence output during this period, but still receive the updated status and the LED is flashing. While download the application and restart, no this waiting time.

Parameter “Send delay after voltage recovery [0..15]s”

This parameter is for setting the delay time to send to bus after the device voltage recovery.

Options: **0..15**

The setting dose not contain the device initialization time, and bus telegrams received during delay time will be recorded.

Parameter “Send cycle of “In operation” telegram [1...240, 0 = inactive]s”

This parameter is for setting the time interval when this device cycle send telegrams through the bus to indicate this module in normal operation. When set to “0”, the object “in operation” will not send a telegram. If the setting is not “0”, the object “In operation” will send a telegram according to the set period time with logic “1” to the bus. Options: **0...240s, 0= inactive**

As to reduce the bus load as much as possible, the maximum time interval should be selected according to actual needs.

Extension function

Parameter "Night mode"

This parameter is for setting whether to enable night mode, default as normal mode when no receive status response.

Parameter "LED indicator"

This parameter is for setting behaviour of LED indicator, used to indicate the status of motion detected or indicate according to external object.

When night mode is enabled, options:

- Disable**
- ON when motion detected**
- ON when motion detected in day**
- Flashing when motion detected**
- Flashing when motion detected in day**
- ON/OFF via external object**
- Flashing via external object**

When night mode is disabled, there are no options "...in day".

Disable: LED indicator function is disabled.

ON when motion detected: the LED is on when detect motion.

ON when motion detected in day: the LED is on when detect motion in day.

Flashing when motion detected: the LED is flashing when detect motion.

Flashing when motion detected in day: the LED is flashing when detect motion in day.

ON/OFF via external object: indicate LED according to the value received from external object, 1-on, 0-off.

Flashing via external object: indicate LED according to the value received from external object, 1-flashing, 0-off.

Sensitivity setting

Parameter "Sensitivity of detector"

Parameter "Sensitivity of detector at day"

Parameter "Sensitivity of detector at night"

This parameter is for setting the sensitivity of sensor, there are 5 levels. You can set the sensitivity for day and night respectively when night mode is enabled. Options:

- Lowest**
- Low**

Medium

High

Highest

Note: only the microwave sensor supports to adjust sensitivity.

Parameter "Behavior detection reference"

This parameter is for setting the reference of behaviour detection. Options:

Only normal movement

Normal/Tiny movement&Static presence

When "Only normal movement" is selected, display following information:

i Sensor movement takes about 2 seconds to define as absence status, which is independent with the follow-up time

When "Normal/Tiny movement&Static presence" is selected, display following information:

i Static presence algorithm takes about 30 seconds to define as absence status, which is independent with the follow-up time

Note: for the microwave sensor, movement takes about 2 seconds to define as absence status, and static presence algorithm takes 30 seconds. These two times are independent to follow-up time. For PIR sensor, there is no need to consider this requirement.

For PIR sensor, option is only **Only normal movement**

5.2.2. Parameter window "Advanced setting"



Fig.5.2.2 "Advanced setting" parameter window

Parameter "RTC function"

Setting page of RTC function is visible after this parameter enabled.

Parameter "Scene Group function"

Setting page of scene group function is visible after this parameter enabled.

Parameter "Logic function"

Setting page of logic function is visible after this parameter enabled.

5.3. Parameter window “Internal sensor measurement”

--- KNX Presence Sensor, Microwave > Internal sensor measurement

<ul style="list-style-type: none"> KNX Secure General Internal sensor measure... Presence function Light control Constant lighting RTC function Logic function Scene Group function 	<p>Brightness sensor setting</p> <p>Brightness calibration: 0 lux</p> <p>Send brightness when the result change by: 50lux</p> <p>Cyclically send brightness [0..255,0=inactive]: 10 min</p> <p>Object datatype of brightness: <input type="radio"/> Value in lux (DPT_7.013) <input checked="" type="radio"/> Float value in lux (DPT_9.004)</p> <p>Brightness calibration can be changed via bus: <input checked="" type="checkbox"/></p> <p>Overwrite changed calibration during download: <input checked="" type="checkbox"/></p> <hr/> <p>Temperature sensor setting</p> <p>Temperature calibration: 0.0 K</p> <p>Send temperature when the result change by: 1.0K</p> <p>Cyclically send temperature [0..255,0=inactive]: 10 min</p> <p>Send alarm telegram for low/high temperature: Respond after read only</p> <p>Threshold value for low temperature alarm [0..15]: 0 °C</p> <p>Threshold value for high temperature alarm [30..45]: 45 °C</p> <hr/> <p>Humidity sensor setting</p> <p>Humidity calibration: 0 %</p> <p>Send humidity when the result change by [0..20]: 5 %</p> <p>Cyclically send humidity [0..255,0=inactive]: 10 min</p> <p>Send alarm telegram for low/high humidity: Respond after read only</p> <p>Threshold value for low humidity alarm [5..20]: 5 %</p> <p>Threshold value for high humidity alarm [70..85]: 85 %</p>
--	---

Fig.5.3 “Internal sensor measurement” parameter window

These following parameters is used for setting the calibration value, sending condition and error report of internal sensor. If internal sensor is selected for other functions as well, please refer to this section.

Brightness sensor setting

Parameter “Brightness calibration”

This parameter is for setting the brightness calibration value of the internal sensor, that is, to calibrate the measured value of internal sensor to make it closer to the current ambient brightness.

Options: **-500..500 lux**

Parameter "Send brightness when the result change by "

This parameter is for setting when brightness turns to a certain value, whether to enable to send the current brightness value to the bus. Not send when disable. Options:

Disable

5 lux

10 lux

15 lux

...

95 lux

Parameter "Cyclically send brightness [0...255,0=inactive]min"

Setting the time for cyclically sending the brightness detection value to the bus. Options: **0..255**

This period is independent and starts time counting after programming or reset. Transmission change has no affect on this period.

Parameter "Object datatype of brightness "

This parameter is for setting the object datatype of brightness. Options:

Value in lux (DPT_7.013)

Float value in lux (DPT_9.004)

Parameter "Brightness calibration can be changed via bus"

This parameter is for setting whether the brightness calibration is changed via bus. When enabled, correct the value via the object "Brightness correction[-500...500]".

Parameter "Overwrite changed calibration during download"

This parameter is visible when previous parameter is enabled. Set whether the brightness calibration value is overwrote during download. Enabled - overwrite, follow the parameter setting; disabled - non-overwrite, it still uses the calibration value.

Temperature sensor setting

Parameter "Temperature calibration"

This parameter is for setting the temperature calibration value of the internal sensor, that is, to calibrate the measured value of internal sensor to make it closer to the current ambient temperature.

Options:

-5K

...

0K

...

5K

Note: after the device is powered on, the stability time of internal sensor detection will take 30 minutes, therefore, the detected temperature value in the early stage of device work may be inaccurate.

Parameter "Send temperature when the result change by"

This parameter is for setting when temperature turns to a certain value, whether to enable to send the current temperature value to the bus. Not send when disable. Options:

Disable

0.5K

1.0K

...

10K

Parameter "Cyclically send temperature [0...255,0=inactive]min"

Setting the time for cyclically sending the temperature detection value to the bus. Options: **0..255**

This period is independent and starts time counting after programming completion or reset. Transmission change has no affect on this period.

Parameter "Send alarm telegram for low/high temperature"

This parameter is for setting condition of sending telegram when low/high temperature alarm.

Options:

No respond

Respond after read only

Respond after change

Respond after read only: Only when the device receives a read alarm from other bus device or bus will the object "Low temperature alarm"/" High temperature alarm" send the alarm status to the bus;

Respond after change: the object " Low temperature alarm"/" High temperature alarm" will immediately send the telegram to the bus to report the alarm value when the alarm status has changed.

These two parameters as follow are visible when "Respond after read only" or "Respond after change" are selected.

—Parameter "Threshold value for low temperature alarm [0..15]° C"

This parameter is for setting the threshold value for low temperature alarm. When the temperature lower than low threshold, low temperature alarm object will send telegram. Options:

0°C

1°C

...

15°C

—Parameter “Threshold value for high temperature alarm [30..45]° C”

This parameter is for setting the threshold value for high temperature alarm. When the temperature higher than high threshold, high temperature alarm object will send telegram. Options:

30°C

31°C

...

45°C

Humidity sensor setting

Parameter “Humidity calibration”

This parameter is for setting the humidity calibration value of the internal sensor, that is, to calibrate the measured value of internal sensor to make it closer to the current ambient humidity.

Options: -20% / -15% / -10% / -5% / -3% / -1% / 0% / 1% / 3% / 5% / 10% / 15% / 20%

Parameter “Send humidity when the result change by [0..20]”

This parameter is for setting when humidity turns to a certain value, whether to enable to send the current humidity value to the bus. Not send when value is 0. Options: 0..20

Parameter “Cyclically send humidity [0..255,0=inactive]min”

Setting the time for cyclically sending the humidity detection value to the bus. Options: 0..255

This period is independent and starts time counting after programming or reset. Transmission change has no affect on this period.

Parameter “Send alarm telegram for low/high humidity”

This parameter is for setting condition of sending telegram when low/high humidity alarm.

Options:

No respond

Respond after read only

Respond after change

Respond after read only: Only when the device receives a read alarm from other bus device or bus will the object “ Low humidity alarm”/“ High humidity alarm” send the alarm status to the bus;

Respond after change: the object “ Low humidity alarm”/“ High humidity alarm” will immediately send the telegram to the bus to report the alarm value when the alarm status has changed.

These two parameters as follow are visible when “Respond after read only” or “Respond after change” are selected.

—Parameter “**Threshold value for low humidity alarm [5..20]%**”

This parameter is for setting the threshold value for low humidity alarm. When the humidity lower than low threshold, low humidity alarm object will send telegram. Options: **5..20**

—Parameter “**Threshold value for high humidity alarm [70..85]%**”

This parameter is for setting the threshold value for high humidity alarm. When the humidity higher than high threshold, high humidity alarm object will send telegram. Options: **70..85**

5.4. Parameter window “Presence function”

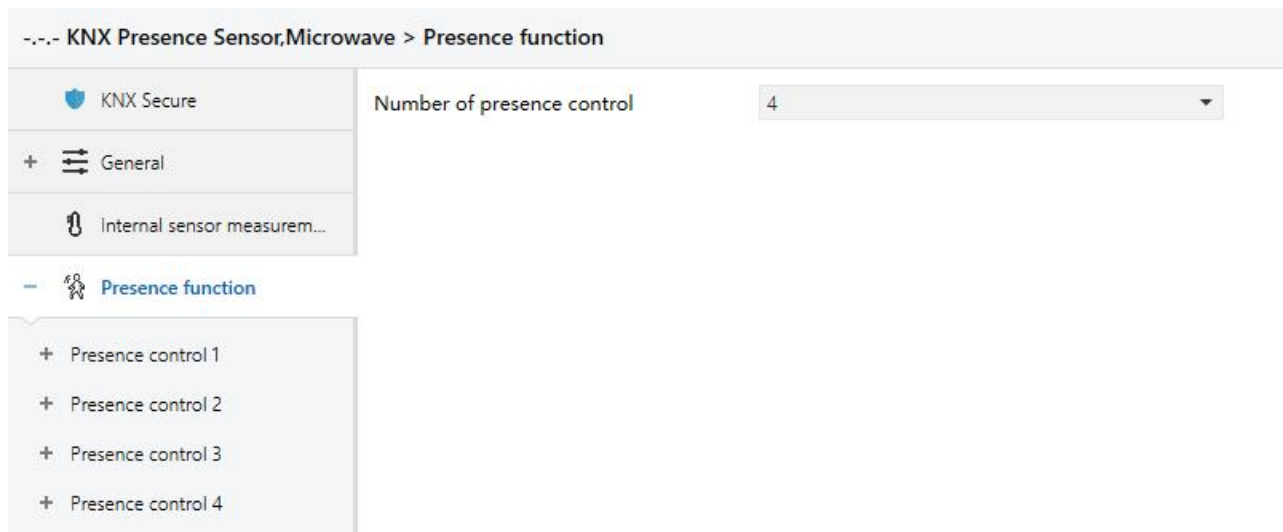

Fig.5.4 “Presence function” parameter window

Parameter “Number of presence control”

This parameter is for setting the number of presence control, up to set 4 controls, if select “None”, presence function is not activated. Options: **None / 1 / 2 / 3 / 4**

5.4.1. Parameter window “Presence control x”

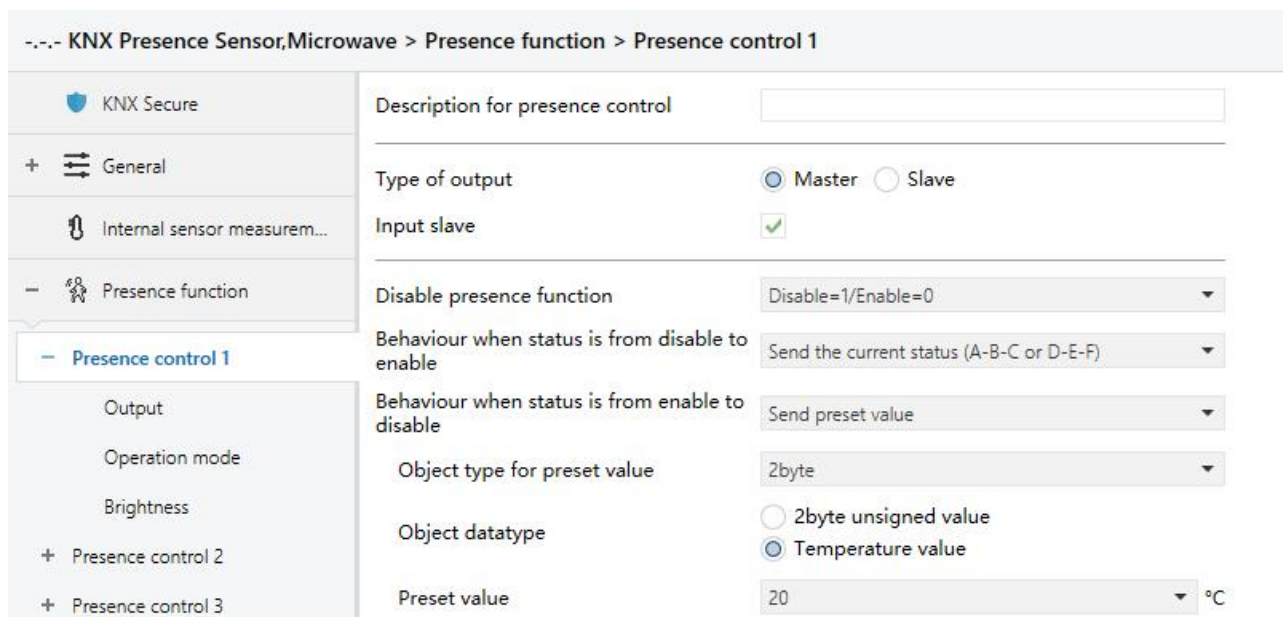

Fig.5.4.1 “Presence control x” parameter window

Parameter “Description for presence control”

This parameter is for setting the name description for current presence control, up to input 30 characters.

Parameter "Type of output"

This parameter is for setting the type of output. Options:

Master

Slave

Master type is used to output control, slave type is mainly used for sending presence signal to the master.

Parameter "Input slave"

This parameter is visible when master type is selected. Used for setting whether support to input slave signal (telegram 1 is valid). Master-slave type is mainly used to extend detected area.

Parameter "Disable presence function"

This parameter is for setting whether to disable or enable presence function, and set the object value. Options:

Disable

Disable=1/Enable=0

Disable=0/Enable=1

Note: detector is enabled by default after programming or reset.

Following parameters are visible when "Disable" is selected and master type:

Parameter "Behaviour when status is from disable to enable"

This parameter is for setting the output behaviour when status is from disable to enable. Options:

No telegram

Send the current status (A-B-C or D-E-F)

Send the value for presence begin (A-B-C)

Send the value for presence end (D-E-F)

Send the current status (A-B-C or D-E-F): send the presence begin value or presence end value according to current is presence status or no presence. A-B-C or D-E-F is performed in order.

Send the value for presence begin (A-B-C): send the presence begin value, process the enable action as a presence trigger action (no consider brightness value factor). A-B-C is performed in order.

Send the value for presence end (D-E-F): send the presence end value, process the enable action as a presence end action (consider the dead time). D-E-F is performed in order.

Note: for detector 2 / 3 / 4, above options has no the description of "B, C, E, F".

Parameter "Behaviour when status is from enable to disable"

This parameter is for setting the output behaviour when status is from enable to disable. Options:

No telegram

Send end value after expiration of the follow-up time

Send the value for presence begin (A-B-C)

Send the value for presence end (D-E-F)

Send preset value

Send end value after expiration of the follow-up time: after disable, send value of presence end D-E-F in order after follow-up time has elapsed. (If it is no movement before disable, and D-E-F is only partially executed, then continue to complete the execution, while if it completes, no any actions.)

Send the value for presence begin (A-B-C): after disable, send value of presence begin A-B-C in order. If the last telegram is set to cyclically send, it is also sent cyclically here.

Send the value for presence end (D-E-F): after disable, send value of presence end D-E-F in order. If the last telegram is set to cyclically send, it is also sent cyclically here.

Send preset value: define the preset value via following parameters.

Note: for detector 2 / 3 / 4, above options has no the description of "B, C, E, F".

—**Parameter "Object type for preset value"**

This parameter is for setting the object type for preset value. Options:

1bit

1byte

2byte

—**Parameter "Object datatype"**

This parameter is for setting the object type for 1byte or 2byte.

When 1byte, options:

1byte unsigned value

1byte percentage value

Scene number

HVAC mode

When 2byte, options:

2byte unsigned value

Temperature value

—**Parameter "Preset value"**

This parameter is for setting the preset value, options display according to the object datatype.

When 1bit, options:

OFF

ON

When 1byte and 1byte unsigned value, options: **0..255**

When 1byte and 1byte percentage value, options:

0%

5%

...

100%

When 1byte and Scene number, options:

Scene No.1

Scene No.2

...

Scene No.64

When 1byte and HVAC mode, options:

Auto

Comfort mode

Standby mode

Economy mode

Frost/heat protection

When 2byte and 2byte unsigned value, options: **0..65535**

When 2byte and Temperature value, options:

-5°C

-4°C

...

44°C

45°C

5.4.1.1. Parameter window “Output”

This parameter is mainly used for setting output telegrams of presence controls, there is different configuration between master type and slave type.

Master type

--- KNX Presence Sensor, Microwave > Presence function > Presence control 1 > Output

- KNX Secure
- + General
- Internal sensor measurem...
- Presence function
- Presence control 1
 - Output**
 - Operation mode
 - Brightness
 - Light control
 - Constant lighting

Begin of presence

If presence is detected, send (A) 1bit ▾

Value OFF ON

If presence still is, send (B) 1bit ▾

Value OFF ON

Detect min. delay time for telegram B [0..255,0=inactive] 60 ▾ s

If presence still is, send (C) 1bit ▾

Value OFF ON

Detect min. delay time for telegram C [0..255,0=inactive] 60 ▾ s

Cyclically send the last telegram [0..255,0=inactive] 0 ▾ s

Follow-up time [10..65535] 120 ▾ s

Overwrite time setting during download

Retrigger function of detector

Telegram D&E refer from telegram C&B

i In this case, whether the telegram E send or not will depend on the telegram B, while the same concept that D depends on C, please check your application to avoid misunderstanding when telegram missing

End of presence

If presence is no longer detected, send (D) 1bit ▾

Value OFF ON

Send second telegram (E) No telegram ▾

Send third telegram (F) No telegram ▾

Cyclically send the last telegram [0..255,0=inactive] 0 ▾ s

Dead time after end of detection [0..255] 5 ▾ s

Dead time is also applied for external input

Allow switch off to end presence

Fig.5.4.1.1 (1) “Output” -Master parameter window

Begin of presence

Up to send 3 telegrams (A / B / C) when begin of presence, the setting of each telegram is the same. Also can set to not sent the telegram, for example, the first telegram A is set to not send, then it will send the second telegram B directly, and telegram C is the same. The three telegrams are configured respectively, the following takes telegram A as an example, detail of B / C not repeat again.

Parameter "If presence is detected, send (A)"

This parameter is for setting the object type for telegram A. Select "No telegram" is not send.

Options:

No telegram

1bit

1byte

2byte

—Parameter "Object datatype"

This parameter is for setting the object type for 1byte or 2byte.

When 1byte, options:

1byte unsigned value

1byte percentage value

Scene number

HVAC mode

When 2byte, options:

2byte unsigned value

Temperature value

—Parameter "Value"

—Parameter "Value at day"

—Parameter "Value at night"

This parameter is for setting the output value, options display according to the object datatype.

Please refer to the setting of preset value, not repeat here.

You can set the output value (besides 1bit) for day and night respectively when night mode is enabled.

—Parameter "Detect min. delay time for telegram B [0..255, 0=inactive]"

This parameter is visible when telegram B is selected to send telegram. Used for setting the minimum delay time for send telegram B. Options: **0..255s, 0=inactive**

After the telegram A has sent, if detect presence during the follow-up time and the minimum time has elapsed, send telegram B immediately.. (**This minimum time starts timing after A is executed.**)

—Parameter “Detect min. delay time for telegram C [0..255, 0=inactive]”

This parameter is visible when telegram C is selected to send telegram. Used for setting the minimum delay time for send telegram C. Options: **0..255s, 0=inactive**

It is similar to telegram B, not explain again here, **note that the minimum time starts timing after B is executed.**

Parameter “Cyclically send the last telegram [0..255,0=inactive]”

This parameter is for setting the period of sending the last telegram cyclically, Options: **0..255s**

For example 3 levels of lighting control A → B → C, when executed to C, telegram C is sent cyclically, stop the cycle after the follow-up time is completed. If telegram C is not configured, send telegram B cyclically, if telegram B is also not configured, send telegram A cyclically.

Parameter “Follow-up time [10..65535]”

This parameter is for setting follow-up time. It can be changed via bus.

Options: **10..65535s**

Note: the minimum time among A, B and C should be smaller than follow-up time, otherwise, the telegram will be ignored. When there is an illegal time setting, display a warning, for example, minimum delay time between B and C is 60s, follow-up time is set to 50s, as follow:

Detect min. delay time for telegram C [0..255,0=inactive]	60	s
Cyclically send the last telegram [0..255,0=inactive]	0	s
Follow-up time [10..65535]	50	s

✘ The follow-up time must be greater than the Min. time of B and C, otherwise the behavior of B or C will be ignored

Parameter “Overwrite time setting during download”

This parameter is for setting whether overwrite follow-up time during download. Enabled - overwrite, follow the parameter setting; disabled - non-overwrite, it still uses the modified time.

Parameter “Retrigger function of detector”

This parameter is for setting whether retrigger function of detector is enabled.

Retrigger function is enabled, there is a presence detected or an external input from bus during follow-up time, the follow-up time is reset. If detect presence before follow-up time is completed, execute telegram B and C in order, if the minimum time of B has not arrived, only execute B when the minimum time is completed and a movement is detected, then start the minimum time of C and execute C.

After A, B, C are completed, execute end telegrams D, E, F when follow-up time has elapsed.

If not detect other presence again after executing A during follow-up time, neither B nor C is executed, please consider the relation between D&E and C&B when follow-up time has elapsed. If D&E refer from telegram C&B, skip D&E and only execute F; while not, execute telegrams D, E, F.

Retrigger function is disabled, execute A-B-C in order according to the minimum time until the follow-up time is completed, after dead time has elapsed, restart only when a trigger command is detected. **Note: execute B-C only when presence is detected, if the minimum time of B is not arrived, execute B when the minimum time is completed and a movement is detected, then start the minimum time of C and execute C. But follow-up time will not reset, only presence is detected will the follow-up reset after dead time has elapsed.**

Parameter "Telegram D&E refer from telegram C&B"

This parameter is for setting whether telegram D and E refer from telegram C and B, used to confirm whether to skip D and E, that is D refer to C, E is refer to B. When enabled, only B is executed will the minimum time and output of E is execute, only C is executed will the minimum time and output of D is execute.

When it is enabled, display following information, please check the application in ETS to avoid thinking that the DE telegram is lost:

 In this case, whether the telegram E send or not will depend on the telegram B, while the same concept that D depends on C, please check your application to avoid misunderstanding when telegram missing

End of presence

Up to send 3 telegrams (D / E / F) when end of presence, the setting of each telegram is the same. Also can set to not sent the telegram, for example, the first telegram D is set to not send, then it will send the second telegram E directly, and telegram F is the same. The three telegrams are configured respectively, the following takes telegram D as an example, detail of E / F not repeat again.

Parameter "If presence is no longer detected, send (D)"

This parameter is for setting the object type for telegram D. Select "No telegram" is not send.

Options:

No telegram

1bit

1byte

2byte

——Parameter "Object datatype"

This parameter is for setting the object type for 1byte or 2byte.

When 1byte, options:

- 1byte unsigned value**
- 1byte percentage value**
- Scene number**
- HVAC mode**

When 2byte, options:

- 2byte unsigned value**
 - Temperature value**
- Parameter “Value”
- Parameter “Value at day”
- Parameter “Value at night”

This parameter is for setting the output value, options display according to the object datatype. Please refer to the setting of preset value, not repeat here.

You can set the output value (besides 1bit) for day and night respectively when night mode is enabled.

- Parameter “Delay for second telegram [0..255]”

This parameter is visible when telegram E is selected to send telegram. Used for setting the delay time for send telegram E. Options: **0..255s**

- Parameter “Delay for third telegram [0..255]”

This parameter is visible when telegram F is selected to send telegram. Used for setting the delay time for send telegram F. Options: **0..255s**

Parameter “Cyclically send the last telegram [0..255,0=inactive]”

This parameter is for setting the period of sending the last telegram cyclically, Options: **0..255s**

For example 3 levels of lighting control D → E → F, when executed to F, telegram F is sent cyclically, stop the cycle after the dead time is completed. If telegram F is not configured, send telegram E cyclically, if telegram E is also not configured, send telegram F cyclically.

Parameter “Dead time after end of detection [0..255]”

This parameter is for setting dead time after end of detection, after follow-up time is completed or external sensor input end signal or receiving OFF status of actuator, start timing. Options: **0..255s**

The delay time among D, E and F should be smaller than dead time, otherwise, the telegram will be ignored (If there is movement).

Example 1: when turn off the light, the nearby ambient temperature will cool in a short time, and it is within the detection range of the detector, this situation can be important. If there is no dead time, an unintentional activation of detector will occur. Dead time is used to prevent re-activating immediately.

Example 2: manually turn off the light when leave room. If there is no dead time, the detected movement will restart the detector during end of presence.

Parameter "Dead time is also applied for external input"

This parameter is for setting whether dead time is also applied for external input, when disabled, execute trigger telegram immediately when detector receives the external input.

Parameter "Allow switch off to end presence"

This parameter is for setting whether allow receiving on/off status of actuator to end presence. When enabled, enter dead time when receive telegram OFF, and suppress presence detection, telegram ON is no meaning. **Only suppress presence detection, but not effect the sending of ABCDEF, they will still follow their own rules.**

Slave type

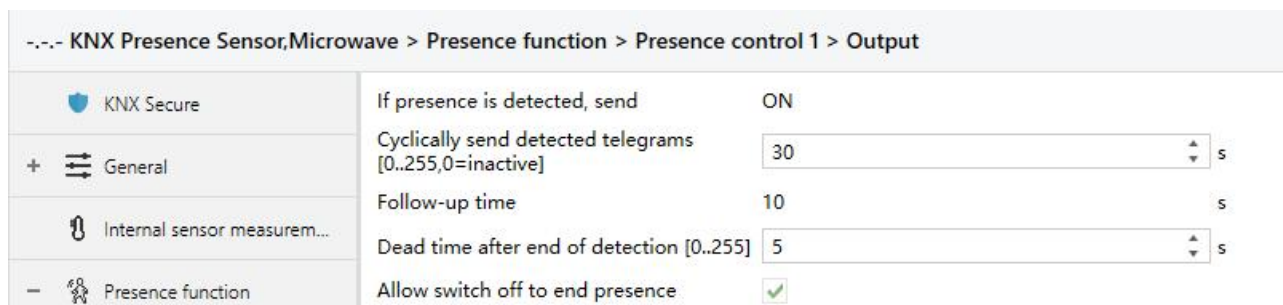

Fig.5.4.1.1 (2) "Output" -Slave parameter window

Parameter "If presence is detected, send"

This parameter is for setting to send telegram to the master on bus when presence detected, option is only **ON**

Parameter "Cyclically send detected telegrams [0..255,0=inactive]"

This parameter is for setting the period of sending the detected telegram cyclically, Options: **0..255s**

Stop to send telegram ON to bus when end of presence, but no OFF telegram is sent.

Parameter "Follow-up time"

This parameter is for setting follow-up time of slave detector, fix to **10s**

Parameter "Dead time after end of detection [0..255]"

This parameter is for setting dead time after end of detection, after follow-up time is completed or external sensor input end signal or receiving OFF status of actuator, start timing. Options: **0..255s**

Parameter "Allow switch off to end presence"

This parameter is for setting whether allow receiving on/off status of actuator to end presence. When enabled, enter dead time when receive telegram OFF, and suppress presence detection, telegram

ON is no meaning.

5.4.1.2. Parameter window “Operation mode”

This parameter is mainly used for setting operation mode of presence controls, it is only applied to master type.

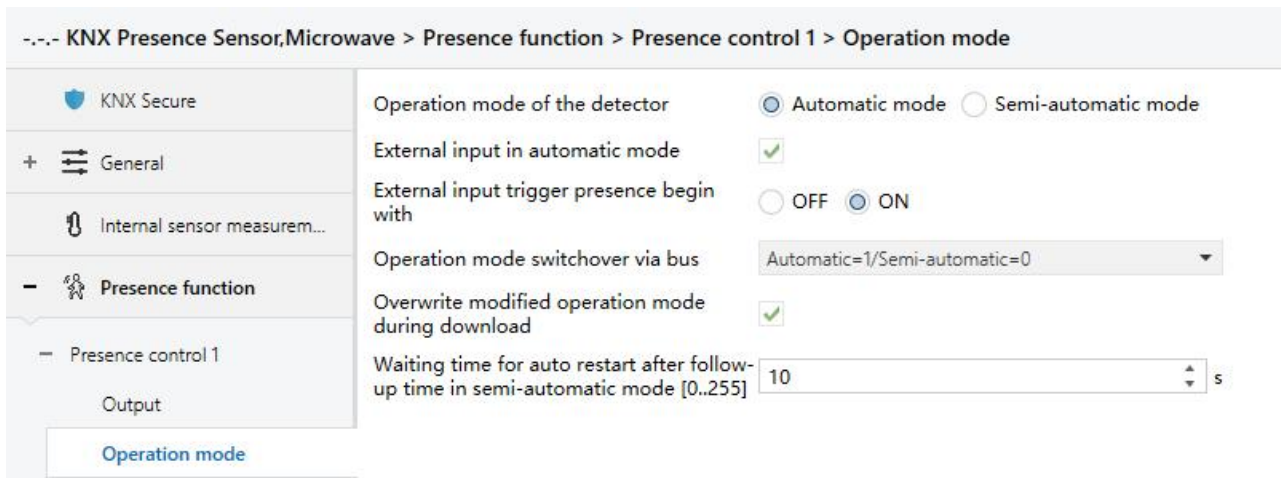

Fig.5.4.1.2 “Operation mode” Parameter window

Parameter “Operation mode of the detector”

This parameter is for setting operation mode of the detector. Options:

Automatic mode

Semi-automatic mode

Automatic mode: begin and end of presence depend on sensor.

Semi-automatic mode: begin of presence is triggered via external input, end of presence depends on sensor or external.

Note: this parameter sets the initial operation mode, change via bus, and keep current operation mode when voltage recovery.

Parameter “External input in automatic mode”

This parameter is for setting whether support external input in automatic mode. When enabled, external input is used as a movement action in automatic mode.

Parameter “Operation mode switchover via bus”

This parameter is for setting whether switchover operation mode via bus. When enabled, you can define the object value. Options:

Disable

Automatic=1/Semi-automatic=0

Automatic=0/Semi-automatic=1

Parameter “Overwrite modified operation mode during download”

This parameter is for setting whether overwrite modified operation mode during download. Enabled - overwrite, follow the parameter setting; disabled - non-overwrite, it still uses the modified operation mode.

Parameter "Waiting time for auto restart after follow-up time in semi-automatic mode [0...255]"

This parameter is for setting the waiting time for auto restart after follow-up time in semi-automatic mode. Options: **0..255s**

Trigger presence detection via external input, end of presence once follow-up time has elapsed. During this waiting time, if detect presence, detection is activated automatically, after this time has passed, presence detection must be turned on again by external input.

5.4.1.3. Parameter window "Brightness"

This parameter is mainly used for setting brightness for presence controls, there is different configuration between master type and slave type.

Master type

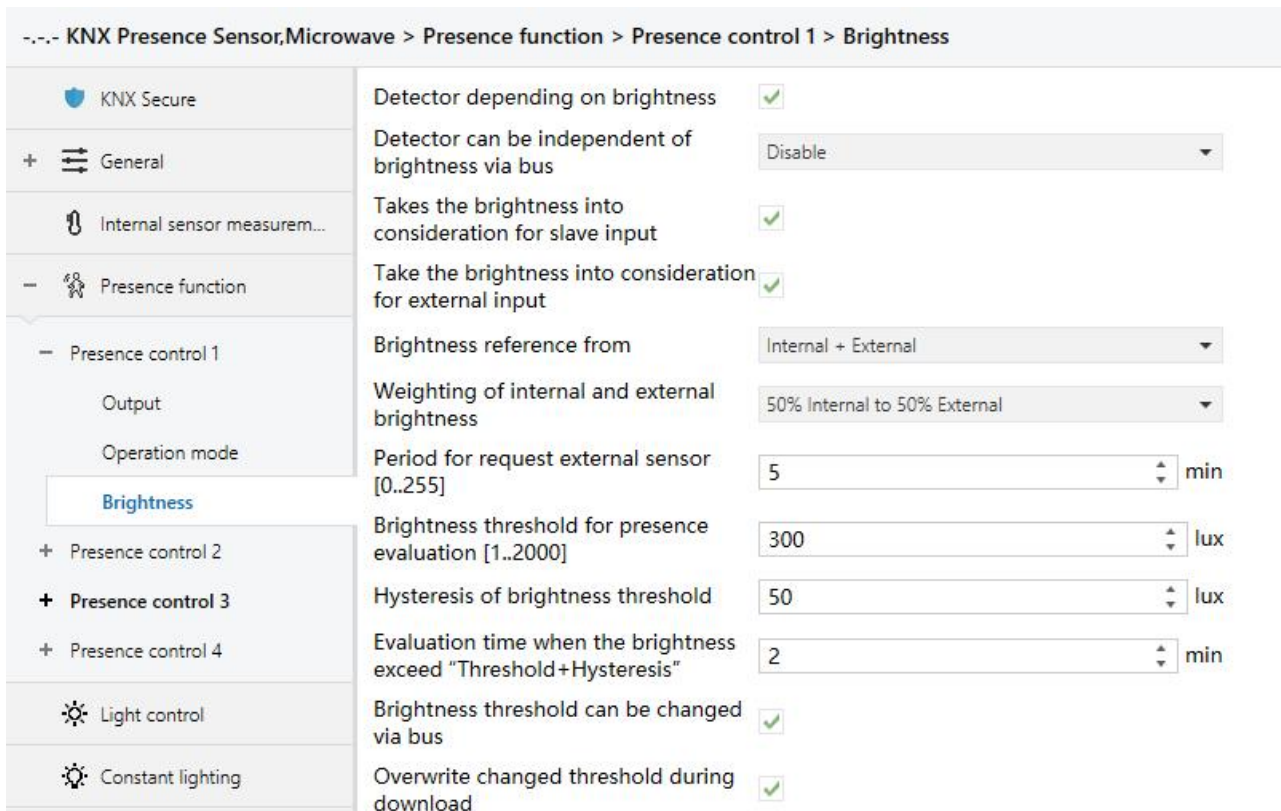

Fig.5.4.1.3(1) "Brightness"-Master parameter window

Parameter "Detector depending on brightness"

This parameter is for setting whether the presence control depending on brightness. When enabled, following parameters are visible.

Parameter "Detector can be independent of brightness via bus"

This parameter is for setting whether detector can be independent of brightness via bus. Options:

Disable

Depending=1/Independent=0

Depending=0/Independent=1

Disable: can not switchover via object, and detector depend on brightness by default.

Depending=1/Independent=0: when device restart, detector depends on brightness by default, you can change to depend on or independent of brightness via the object, telegram 0 is independent, telegram 1 is depending. The same goes for option "Depending=0/Independent=1".

Parameter "Takes the brightness into consideration for slave input"

This parameter is visible when parameter "Input slave" is enabled. Used for setting whether take the brightness into consideration for slave input.

When enabled, only when actual brightness is lower than brightness threshold will turn on detector or reset follow-up time; when disabled, independent of brightness, each input telegram ON can turn on detector or reset follow-up time.

For processing within the hysteresis interval, refer to the description of the hysteresis value.

Parameter "Take the brightness into consideration for external input"

This parameter is for setting whether take the brightness into consideration for external input.

When enabled, only when actual brightness is lower than brightness threshold will turn on detector or reset follow-up time; when disabled, trigger the detector directly.

For processing within the hysteresis interval, refer to the description of the hysteresis value.

Parameter "Brightness reference from"

This parameter is for setting the reference of brightness. Options:

Internal only

External only

Internal + External

When depend on brightness, if external brightness is not obtained (sensor error), there is only presence and will not output telegram.

Parameter "Weighting of internal and external brightness"

This parameter is visible when "Internal + External" is selected. Used for setting the weighting of internal and external brightness. Options:

10% Internal to 90% External

20% Internal to 80% External

...

90% Internal to 10% External

When two sensors are combined for detection, if one of the sensors fails, use the brightness value detected by the other sensor.

Parameter "Period for request external sensor [0..255]"

This parameter is visible when "...External..." is selected. Used for setting the period for request external sensor. Options: **0..255s**

Parameter "Brightness threshold for presence evaluation [1..2000]"

This parameter is for setting the brightness threshold for evaluating begin of presence. It can be changed via bus.

Options: **1..2000 lux**

Only when brightness lower than this threshold, and there is a presence (in Automatic mode) or external input (if configured), detector will execute begin of presence.

Parameter "Hysteresis of brightness threshold"

This parameter is for setting the brightness hysteresis for end of presence. Options: **10..200 lux**

When the brightness reaches the "brightness threshold + hysteresis value" for a period of time (next parameter to define), even if there is a presence, it will execute end of presence. During brightness hysteresis interval, the operating logic of brightness and presence is determined by the previous status (for example, brightness changes upward from below the threshold, begin of presence, while the brightness goes down from above the threshold, can not begin of presence).

Parameter "Evaluation time when the brightness exceed "Threshold+Hysteresis" "

This parameter is for setting the evaluation time when brightness reaches the "brightness threshold + hysteresis value", once this time has elapsed, presence detection is no longer processed.

Options: **1..20 min**

Parameter "Brightness threshold can be changed via bus"

This parameter is for setting whether brightness threshold can be changed via bus.

Parameter "Overwrite changed threshold during download"

This parameter is visible when previous parameter is enabled. Used for setting whether overwrite modified brightness threshold during download. Enabled - overwrite, follow the parameter setting; disabled - non-overwrite, it still uses the modified brightness threshold.

Slave type

--- KNX Presence Sensor,Microwave > Presence function > Presence control 1 > Brightness

<ul style="list-style-type: none"> 🛡️ KNX Secure + ≡ General 🔌 Internal sensor measurem... - 👤 Presence function - Presence control 1 <ul style="list-style-type: none"> Output Brightness + Presence control 2 + Presence control 3 + Presence control 4 ⚙️ Light control 	<ul style="list-style-type: none"> Detector depending on brightness <input checked="" type="checkbox"/> Detector can be independent of brightness via bus Disable ▾ Brightness reference from Internal + External ▾ Weighting of internal and external brightness 50% Internal to 50% External ▾ Period for request external sensor [0..255] 5 ▾ min Brightness threshold for presence evaluation [1..2000] 300 ▾ lux Hysteresis of brightness threshold 50 ▾ lux Evaluation time when the brightness exceed "Threshold+Hysteresis" 2 ▾ min Brightness threshold can be changed via bus <input checked="" type="checkbox"/> Overwrite changed threshold during download <input checked="" type="checkbox"/>
---	--

Fig.5.4.1.3(2) "Brightness"-Slave parameter window

When slave type, not take brightness into consideration for slave input / external input. Other parameters is similar to master type, not repeat here.

5.5. Parameter window “Light control”

Fig.5.5 “Light control” parameter window

Parameter “Light control”

This parameter is for setting whether the light control is enabled. Compare the setting brightness threshold with current brightness, to output switch or scene control telegrams.

When enabled, following parameters are visible.

Parameter “Disable function”

This parameter is for setting whether disable function of light control is enabled. Options:

Disable

Disable=1/Enable=0

Disable=0/Enable=1

Note: the detector is enabled by default after programming or reset.

Brightness value setting

Parameter “Reference internal brightness”

This parameter is for setting whether reference internal brightness.

The reference of brightness is optional internal, external, proportional mixing internal+external, the mixing data need to be fed back to bus. It is up to set 3 external brightness sensors.

Parameter “Number of reference external brightness”

This parameter is for setting the number of reference external brightness sensors.

Previous parameter is enabled, options: **0 / 1 / 2 / 3**

Previous parameter is disabled, options: **1 / 2 / 3**

Parameter "Weighting of internal brightness"

Parameter "Weighting of external brightness x" (x=1~3)

This parameter is for setting the weighting of internal or external brightness sensors. Options:

10%

20%

...

100%

The weighting of each sensor is setting independently by parameters, then add up these data as the brightness used for controlling. When there is only one (internal or external) sensor, these parameters is not visible.

Note: when Any one of these sensors went wrong (including internal sensor), still consider its weighting, however, because it is illegal data, it will not be actively sent to the bus, and there will be no control output, keeping the current status.

Parameter "Period for request external sensor [0...255] min"

This parameter is visible when there is External sensor. Used for setting the period for request brightness from external sensor. Options: **0 ..255**

Send a read request to external sensor after bus recovery or finish programming.

Parameter "Send brightness when the result change by "

This parameter is visible when there is a combination of internal and external sensors. Used for setting when brightness turns to a certain value, whether to enable to send the current brightness value to the bus. Not send when value "Disable" is selected. Options:

Disable

5 lux

10 lux

15 lux

...

95 lux

Parameter "Cyclically send brightness [0...255,0=inactive]"

This parameter is visible when there is a combination of internal and external sensors. Used for setting the time for cyclically sending the brightness detection value to the bus. Options: **0..255 min**

This period is independent and starts time counting after programming or reset. Transmission change has no affect on this period.

5.5.1. Parameter window “Output”

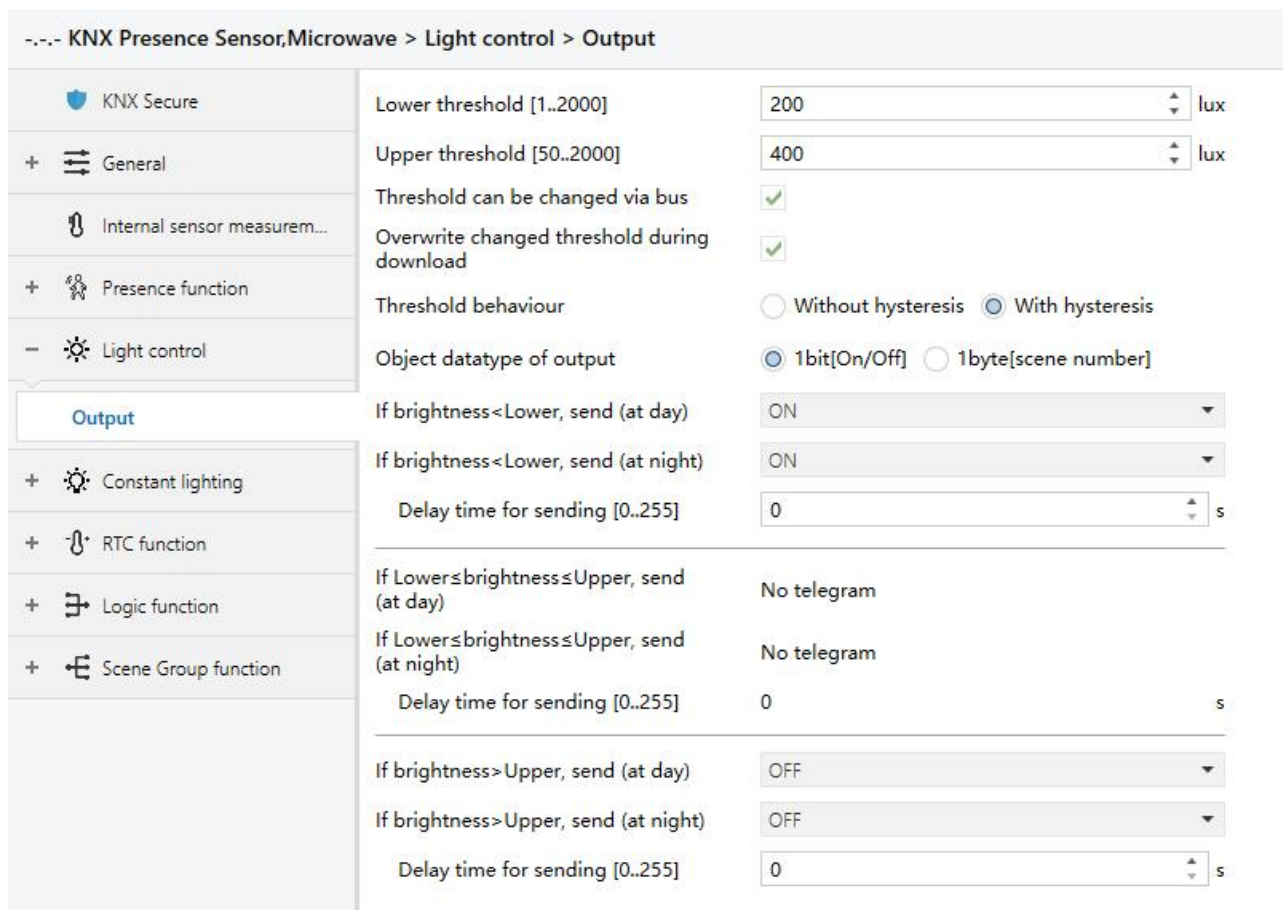

Fig.5.5.1 “Output” parameter window

Parameter “Lower threshold [1..2000]”

This parameter is for setting the lower threshold of brightness. Options: **1..2000 lux**

Parameter “Upper threshold [50..2000]”

This parameter is for setting the upper threshold of brightness. Options: **50..2000 lux**

Note: the threshold value must meet the condition lower < upper, if not, they can not be configured on ETS, and display red box warning, as shown as follow:



Parameter “Threshold can be changed via bus”

This parameter is for setting whether lower and upper threshold can be changed via bus.

Parameter “Overwrite changed threshold during download”

This parameter is visible when previous parameter is enabled. Used for setting whether overwrite modified range of brightness threshold during download. Enabled - overwrite, follow the parameter setting; disabled - non-overwrite, it still uses the modified brightness threshold range.

Parameter "Threshold behaviour"

This parameter is for setting threshold behaviour. Options:

Without hysteresis

With hysteresis

When with hysteresis, the range of lower and upper threshold is used as a buffer, and no action occurs when the brightness is in it.

Parameter "Object datatype of output"

This parameter is for setting the object datatype of output. Options:

1bit[On/Off]

1byte[scene number]

Support to compare lower and upper brightness threshold with brightness to output telegrams, parameters as shown as follow, which can apply to turn on/off light or scene recall.

Parameter "If brightness<Lower, send"

Parameter "If brightness<Lower, send (at day)"

Parameter "If brightness<Lower, send (at night)"

This parameter is for setting the output telegram when brightness is lower than lower threshold. You can set the output value for day and night respectively when night mode is enabled.

When 1bit, options:

No telegram

ON

OFF

When 1byte, options:

No telegram

Scene No.1

Scene No.2

...

Scene No.64

—Parameter "Delay time for sending [0..255]"

This parameter is for setting the delay time for sending output telegram. Options: **0..255 s**
If brightness is higher than lower threshold during delay time, previous timing is ignored.

Parameter "If Lower<brightness<Upper, send"

Parameter "If Lower<brightness<Upper, send (at day)"

Parameter "If Lower<brightness<Upper, send (at night)"

This parameter is for setting the output telegram when brightness is between lower and upper thresholds. You can set the output value for day and night respectively when night mode is enabled.

When 1bit, options:

No telegram

ON

OFF

When 1byte, options:

No telegram

Scene No.1

Scene No.2

...

Scene No.64

When with hysteresis, option is only **No telegram**, that is no output telegram and the delay time is default to 0.

—Parameter “Delay time for sending [0..255]”

This parameter is for setting the delay time for sending output telegram. Options: **0..255 s**

If brightness is lower than lower threshold or higher than upper threshold during delay time, previous timing is ignored.

Parameter “If brightness>Upper, send”

Parameter “If brightness>Upper, send (at day)”

Parameter “If brightness>Upper, send (at night)”

This parameter is for setting the output telegram when brightness is higher than upper threshold. You can set the output value for day and night respectively when night mode is enabled.

When 1bit, options:

No telegram

ON

OFF

When 1byte, options:

No telegram

Scene No.1

Scene No.2

...

Scene No.64

—Parameter “Delay time for sending [0..255]”

This parameter is for setting the delay time for sending output telegram. Options: **0..255 s**

If brightness is lower than upper threshold during delay time, previous timing is ignored.

5.6. Parameter window “Constant lighting”

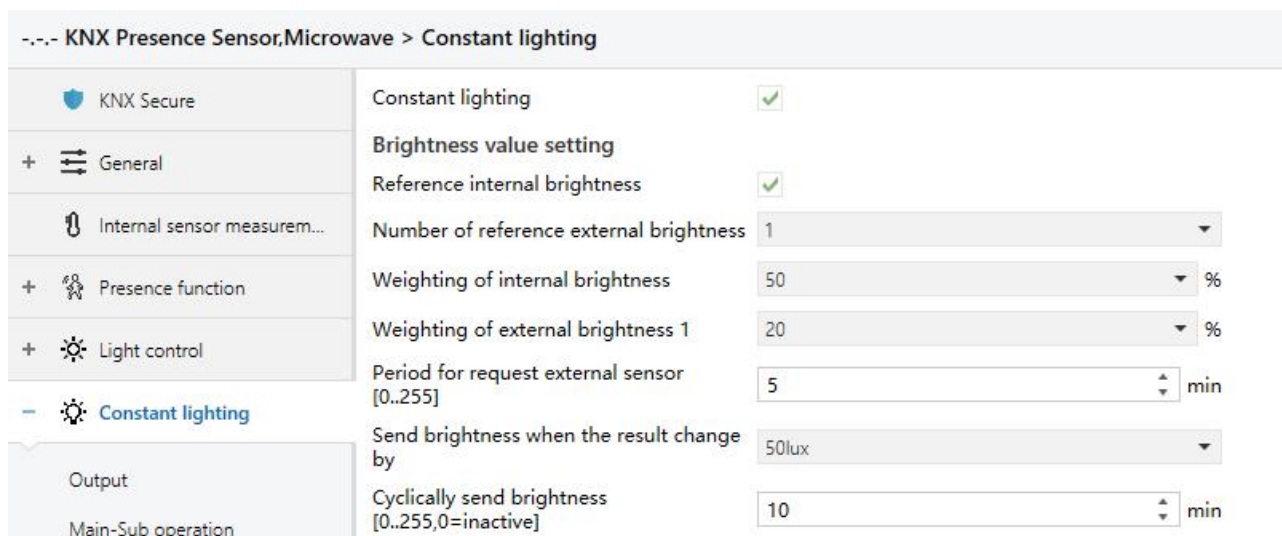

Fig.5.6 “Constant lighting” parameter window

Parameter “Constant lighting”

This parameter is for setting whether the constant lighting is enabled, to maintain brightness at a certain value. When enabled, following parameters are visible.

Brightness value setting

Parameter “Reference internal brightness”

This parameter is for setting whether reference internal brightness.

The reference of brightness is optional internal, external, proportional mixing internal+external, the mixing data need to be fed back to bus. It is up to set 3 external brightness sensors.

Parameter “Number of reference external brightness”

This parameter is for setting the number of reference external brightness sensors.

Previous parameter is enabled, options: **0 / 1 / 2 / 3**

Previous parameter is disabled, options: **1 / 2 / 3**

Parameter “Weighting of internal brightness”

Parameter “Weighting of external brightness x” (x=1~3)

This parameter is for setting the weighting of internal or external brightness sensors. Options:

10%

20%

...

100%

The weighting of each sensor is setting independently by parameters, then add up these data as the brightness used for controlling. When there is only one (internal or external) sensor, these

parameters is not visible.

Note: when Any one of these sensors went wrong (including internal sensor), still consider its weighting, however, because it is illegal data, it will not be actively sent to the bus, and there will be no control output, keeping the current status.

Parameter "Period for request external sensor [0..255]"

This parameter is visible when there is External sensor. Used for setting the period for request brightness from external sensor. Options: **0 ..255 min**

Send a read request to external sensor after bus recovery or finish programming.

Parameter "Send brightness when the result change by "

This parameter is visible when there is a combination of internal and external sensors. Used for setting when brightness turns to a certain value, whether to enable to send the current brightness value to the bus. Not send when value "Disable" is selected. Options:

Disable

5 lux

10 lux

15 lux

...

95 lux

Parameter "Cyclically send brightness [0..255,0=inactive]"

This parameter is visible when there is a combination of internal and external sensors. Used for setting the time for cyclically sending the brightness detection value to the bus. Options: **0..255 min**

This period is independent and starts time counting after programming or reset. Transmission change has no affect on this period.

5.6.1. Parameter window “Output”

--- KNX Presence Sensor, Microwave > Constant lighting > Output

<ul style="list-style-type: none"> KNX Secure + General Internal sensor measurem... + Presence function Light control - Constant lighting Output Main-Sub operation + RTC function + Logic function + Scene Group function 	<p>Trigger telegram of controller on A of local presence 1 begin ▼</p> <p>Trigger telegram of controller off D of local presence 1 end ▼</p> <p>Constant lighting status after download <input type="radio"/> OFF <input checked="" type="radio"/> ON</p> <p>Constant lighting status after voltage recovery As before voltage failure ▼</p> <hr/> <p>Initial dimming value when control starts (at day) Via request actuator status ▼</p> <p>Initial dimming value when query fails <input type="text" value="50"/> %</p> <p>Setpoint brightness [1..2000] <input type="text" value="400"/> lux</p> <p>Initial dimming value when control starts (at night) Via parameter setting ▼</p> <p>Dimming value <input type="text" value="20"/> %</p> <hr/> <p>Hysteresis with setpoint +/-10 ▼ %</p> <p>Setpoint value can be changed via bus <input checked="" type="checkbox"/></p> <p>Min. brightness setpoint [1..2000] <input type="text" value="50"/> lux</p> <p>Max. brightness setpoint [100..2000] <input type="text" value="1600"/> lux</p> <p>Overwrite changed setpoint during download <input checked="" type="checkbox"/></p> <hr/> <p>Control speed <input type="text" value="02:30"/> mm:ss</p> <p>Cyclically send dimming value [0..255,0=inactive] <input type="text" value="0"/> s</p> <p>Send dimming value when the result change by <input type="text" value="1"/> %</p> <p>Min. dimming value for main <input type="text" value="0"/> %</p> <p>Max. dimming value for main <input type="text" value="100"/> %</p> <hr/> <p>Delay time for standby [0..255,0=inactive] <input type="text" value="3"/> min</p> <p>Additional hysteresis for controller restart from standby <input type="text" value="100"/> lux</p> <hr/> <p>Stop function <input checked="" type="checkbox"/></p> <p>Controller automatically restart after [0..255,0=inactive] <input type="text" value="0"/> min</p>
--	--

Fig.5.6.1 “Output” parameter window

Parameter “Trigger telegram of controller on”

This parameter is for setting external or local presence sensor to trigger controller on, send controller status when it changes.

Options is related to the number of local presence detector:

ON of external presence sensor

A of local presence 1 begin

B of local presence 1 begin

...

A of local presence 4 begin

When there is none local presence detector, option is only **ON of external presence sensor**

When controller is triggered via local sensor, you can configure the specific telegram when begin presence. **If the selected telegram is not activated, a warning is displayed, for example, select telegram A of presence detector 1 but it is not activated:**

Trigger telegram of controller on

✘ A of local presence 1 begin is no telegram, please active to use controller normally

Parameter "Trigger telegram of controller off"

This parameter is for setting external presence sensor or local presence sensor to trigger controller off, send controller status when it changes.

Options is related to the number of presence detector:

OFF of external presence sensor

D of local presence 1 end

E of local presence 1 end

...

D of local presence 4 end

When there is none local presence detector, option is only **OFF of external presence sensor**

When controller is triggered via local sensor, you can configure the specific telegram when end presence. **If the selected telegram is not activated, a warning is displayed, for example, select telegram D of presence detector 1 but it is not activated:**

Trigger telegram of controller off

✘ D of local presence 1 end is no telegram, please active to use controller normally

Note: if the selected telegram is not configured, or the local presence sensor is not configured or disabled, once the controller is turned off, there is no way to trigger it again via the sensor, so, the configuration should be synchronized with the configuration of the local presence sensor.

Parameter "Constant lighting status after download"

This parameter is for setting constant lighting status after download. Options:

OFF

ON

Parameter "Constant lighting status after voltage recovery"

This parameter is for setting constant lighting status after voltage recovery. Options:

OFF

ON

As before voltage failure

Parameter "Initial dimming value when control starts"

Parameter "Initial dimming value when control starts (at day)"

This parameter is for setting initial dimming value of the main when control starts. You can set the output value for day independently with this parameter when night mode is enabled. Options:

Via parameter setting

Via request actuator status

Via calculate start value

The sub brightness output is calculated from the influence of proportional for sub to the main. **(As long as the adjustment reaches the level of the main, the brightness control always follows the proportional output; when it can not reach the level, increase all area's brightness level in any case, until all areas reach the maximum dimming value)**

Parameter "Initial dimming value"

This parameter is visible when "Via parameter setting" is selected. Used for setting initial dimming value. Options: **1..100%**

Parameter "Initial dimming value when query fails"

This parameter is visible when "Via query actuator status" is selected. Used for setting initial dimming value when fail to query actuator or read 0. Options: **1..100%**

Parameter "Setpoint brightness [1..2000]"

This parameter is for setting brightness setpoint value. Options: **1..2000 lux**

Parameter "Initial dimming value when control starts (at night)"

This parameter is visible when night mode is enabled. Used for setting initial dimming value of the main for night when control starts. Options:

Via parameter setting

Via request actuator status

Via calculate start value

When controller is always on, from day mode to night mode, brightness value will slowly update to the setting in night mode.

Parameter "Dimming value"

This parameter is visible when "Via parameter setting" is selected. Used for setting dimming value.

Options: **1..100%**

Parameter “Dimming value when query fails”

This parameter is visible when “Via query actuator status” is selected. Used for setting dimming value when fail to query actuator or read 0. Options: **1..100%**

Parameter “Setpoint brightness [1..2000]”

This parameter is visible when “Via calculate start value” is selected. Used for setting brightness setpoint value. Options: **1..2000 lux**

Parameter “Hysteresis with setpoint”

This parameter is for setting hysteresis percent with setpoint of the main output. Options:

- +/-5%**
- +/-10%**
- +/-15%**
- +/-20%**

Hysteresis value = Current setpoint value × Hysteresis percent

Compare current brightness with setpoint value, when the brightness is higher than “Setpoint value + Hysteresis value”, the lamp slowly darkens until is lower than “Setpoint value + Hysteresis value”, to maintain output; when the brightness is lower than “Setpoint value - Hysteresis value”, the lamp slowly brightens until is higher than “Setpoint value - Hysteresis value”, to maintain output.

Parameter “Setpoint value can be changed via bus”

This parameter is for setting whether setpoint value can be changed via bus.

When enabled, following parameter is visible:

Parameter “Min. brightness setpoint [1..2000]”

Parameter “Max. brightness setpoint [100..2000]”

This parameter is for setting the minimum and maximum brightness setpoint value.

Options of minimum value: **1..2000 lux**; options of maximum value: **100..2000 lux**

Note: it must meet the condition minimum value < maximum value, if not, they can not be configured on ETS, and display red box warning, as shown as follow:

Min. brightness setpoint [1..2000]	<input type="text" value="200"/>	lux
Max. brightness setpoint [100..2000]	<input style="border: 2px solid red;" type="text" value="150"/>	lux

Parameter “Overwrite changed setpoint during download”

This parameter is for setting whether overwrite modified brightness setpoint value during download. Enabled - overwrite, follow the parameter setting; disabled - non-overwrite, it still uses the modified brightness setpoint value.

Parameter "Control speed"

This parameter is for setting the control speed of the whole time, the shorter time, the faster the dimming control value changes. Such as set to 200 seconds, that is adjust 0.5% brightness for 1 second. Options: **2:30..20:00 mm:ss**

Parameter "Cyclically send brightness [0..255,0=inactive]min"

This parameter is for setting the time for cyclically sending the brightness value to the bus.

Options: **0..255 min**

This period is independent and starts time counting after programming or reset. Transmission change has no affect on this period.

Parameter "Send brightness when the result change by "

This parameter is for setting the time for when brightness turns to a certain value to send the current brightness value to the bus. Options:

- 1%
- 2%
- 3%
- 4%
- 5%

Parameter "Min. dimming value for main"

Parameter "Max. dimming value for main"

These parameter are for setting the minimum and maximum dimming value for the main.

Options of the minimum: **0..50 %**; options of the maximum: **51..100 %**

Parameter "Delay time for standby [0..255,0=inactive]"

This parameter is for setting the delay time when controller enter standby status. Options: **0..255 min**

When the output is the minimum dimming value and current brightness is still higher than "Setpoint value + Hysteresis value", the controller enter standby status, output telegram OFF and brightness 0%. When the delay time is 0, the controller is always active, output the minimum dimming value.

Note: the controller does not enter standby status when in night mode.

Parameter "Additional hysteresis for controller restart from standby"

This parameter is not visible when delay time is 0. Used for setting additional hysteresis for controller restart automatically from standby status. Options: **0..255 lux**

When current brightness is lower than "Setpoint value - Hysteresis value - Additional hysteresis", activate controller. **Note: if "Setpoint value - Hysteresis value - Additional hysteresis" is lower than 50**

lux, use 50 lux to restart from standby status.

Parameter "Stop function"

This parameter is for setting whether the stop function. When enabled, display objects 1bit/4bit/1byte, when receive command, controller becomes inactive. **(The output of the dimmer remains in the status of external control, if the output of the controller is not updated, not send the telegram OFF, and only the controller status changes to OFF.)**

Parameter "Controller automatically restart after [0..255,0=inactive]"

This parameter is visible when previous parameter is enabled. Used for setting the delay time for controller automatically restart from stop status. 0 is not automatically activate, and activate controller via external object or presence detection. If there is a delay time, automatically return to active status.

Options: **0..255 min**

5.6.2. Parameter window “Main-Sub operation”

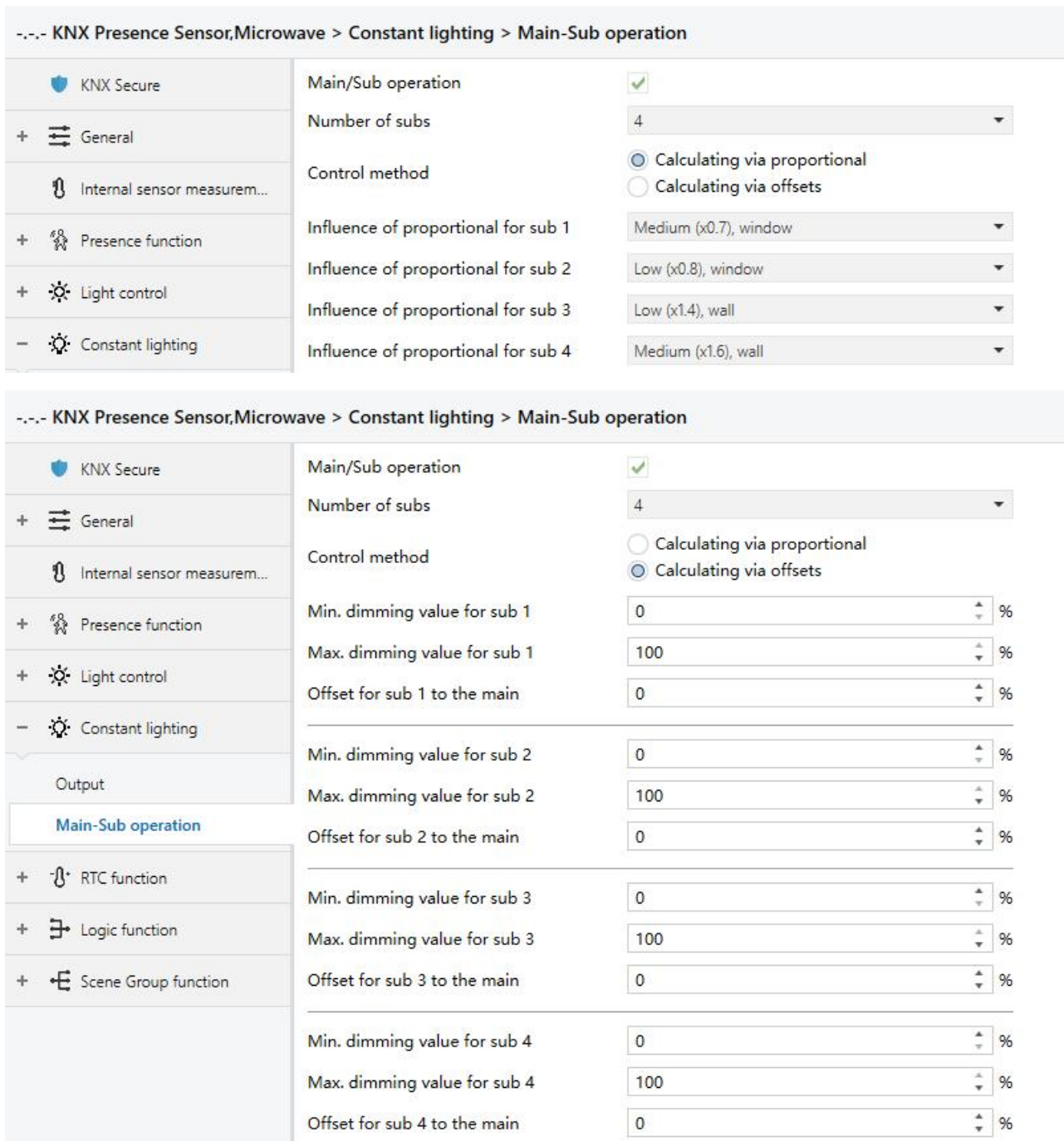

Fig.5.6.2 “Main-Sub operation” parameter window

Parameter “Main/Sub operation”

This parameter is for setting whether Main/Sub operation is enabled. When enabled, following parameters are visible:

Parameter “Number of subs”

This parameter is for setting the number of subs, up to set 4 subs.

Parameter "Control method"

This parameter is for setting control method. Options:

Calculating via proportional

Calculating via offsets

Following parameters are visible when "Calculating via proportional" is selected:

Parameter "Influence of proportional for sub x" (x=1~4)

This parameter is for setting influence of proportional of sub x to the main. Options:

Very high (x0.5), window

High (x0.6), window

Medium (x0.7), window

Low (x0.8), window

Very low (x0.9), window

No change (x1)

Very low (x1.2), wall

Low (x1.4), wall

Medium (x1.6), wall

High (x1.8), wall

Very high (x2.0), wall

When "No change (x1)" is selected, close proportional control, the all lighting groups lights up with the same value.

When "Very high (x0.5), window" or "Very high (x2.0), wall" is selected, it means that a large difference between the absolute dimming values at the wall and the window.

The sensor is usually installed in the middle position, and set it as the main lighting group, and the sub lighting group is located in the window or wall area.

Following parameters are visible when "Calculating via offsets" is selected:

Parameter "Min. dimming value for sub x" (x=1~4)

Parameter "Max. dimming value for sub x" (x=1~4)

These parameters are for setting the minimum and maximum value for sub x.

Options of the minimum: **0..50 %**; options of the maximum: **51..100 %**

Parameter "Offset for sub x to the main" (x=1~4)

This parameter is for setting output offset for sub x to the main. Options: **-100...100 %**

5.7. Parameter window “RTC function”

--- KNX Presence Sensor, Microwave > RTC function

<ul style="list-style-type: none"> KNX Secure General Internal sensor measurement... Presence function Light control Constant lighting RTC function <ul style="list-style-type: none"> Setpoint Heating/Cooling control Fan auto.control Logic function Scene Group function 	<p>Room temperature reference from: Internal sensor combine with External sensor</p> <p>Combination ratio: 50% Internal to 50% External</p> <p>Time period for request room temperature sensor [0..255]: 10 min</p> <p>Send temperature when the result change by: 1.0K</p> <p>Cyclically send temperature [0..255]: 0 min</p> <p>Control value after temp. error[0..100] (if 2-point control, set value '0'=0, set value '>0'=1): 0 %</p> <hr/> <p>Room temperature control mode: Heating and Cooling</p> <p>Heating/Cooling switchover: <input checked="" type="radio"/> Via object <input type="radio"/> Automatic changeover</p> <p>Heating/Cooling status after download: <input checked="" type="radio"/> Heating <input type="radio"/> Cooling</p> <p>Heating/Cooling status after voltage recovery: As before voltage failure</p> <p>Room temperature control system: <input checked="" type="radio"/> 2 pipes system <input type="radio"/> 4 pipes system</p> <hr/> <p>Operation mode: <input checked="" type="checkbox"/></p> <p>Controller status after download: Comfort mode</p> <p>Controller status after voltage recovery: As before voltage failure</p> <p>Extended comfort mode [0..255,0=inactive]: 0 min</p> <p>1 bit object function for operation mode: <input checked="" type="checkbox"/></p> <p>1 bit object for standby mode: <input checked="" type="checkbox"/></p> <hr/> <p>Fan speed auto.control function: <input checked="" type="checkbox"/></p> <hr/> <p>Window contact input function: <input checked="" type="checkbox"/></p> <p>Delay for window contact [0..65535]: 15 s</p> <p>Controller mode for open window: <input type="radio"/> Economy mode <input checked="" type="radio"/> Frost/heat protection</p> <p>Bus presence detector function: <input checked="" type="checkbox"/></p> <p>Trigger telegram of occupied: A of local presence 1 begin</p> <p>Trigger telegram of unoccupied: D of local presence 1 end</p>
--	--

Fig.5.7 “RTC function” parameter window

Parameter “Room temperature reference from”

This parameter is for setting the resource of the RTC function temperature reference. Options:

Internal sensor

External sensor

Internal sensor combine with External sensor

When selecting the reference internal sensor, the temperature is determined by the setting of the

“Internal sensor measurement” in the parameter interface, more details refer to chapter 5.3.

— **Parameter “Period for request external sensor [0...255]”**

This parameter is visible when “...External sensor” is selected. Set the time period for read request external temperature sensor. Options: **0..255 min**

Parameters as follow are visible when “Internal sensor combine with External sensor” is selected.

— **Parameter “Combination ratio”**

This parameter is for setting the internal sensor and the external sensor to measure the specific gravity of the temperature. Options:

- 10% Internal to 90% External**
- 20% Internal to 80% External**
- ...
- 90% Internal to 10% External**

For example, if the option is “40% internal to 60% external”, then the internal sensor accounts for 40%, the external sensor accounts for 60%, and the control temperature = (internal sensor's temperature × 40%) + (external sensor's temperature × 60%), the RTC function of the device will control and display the temperature according to the calculated temperature.

When two sensors are combined for detection, when one sensor is in error, the temperature value detected by the other sensor is used.

— **Parameter “Send temperature when the result change by”**

This parameter is for setting when temperature turns to a certain value, whether to enable to send the current temperature value to the bus. Not send when disable. Options:

- Disable**
- 0.5K**
- 1.0K**
- ...
- 10K**

— **Parameter “Cyclically send temperature [0...255]”**

Setting the time for cyclically sending the temperature detection value to the bus. Not send when value is 0.

Options: **0..255 min**

Note: cyclically sending and change sending are independent of each other.

Parameter “Control value after temp. error[0..100] (if 2-point control, set value '0'=0, set value '>0'=1)”

This parameter is for setting the control value when temperature error occur. Options: **0..100 %**

If 2-Point control, then the parameter value is 0, as well as the control value; if the parameter value

is more than 0, then the control value will be 1.

Parameter "Room temperature control mode"

This parameter is for setting room temperature control mode. Options:

Heating

Cooling

Heating and Cooling

Parameters as follow are visible when "Heating and Cooling" is selected

—Parameter "Heating/Cooling switchover"

This parameter is for setting the switchover way of Heating/Cooling. Options:

Via object

Automatic changeover

—Parameter "Heating/Cooling status after download"

This parameter is for setting the heating/cooling control mode of device when power on RTC after download. Options:

Heating

Cooling

—Parameter "Heating/Cooling status after voltage recovery"

This parameter is for setting the heating/cooling control mode of device when power on RTC after voltage recovery. Options:

Heating

Cooling

As before voltage failure

As before voltage failure: When the device is reset after power on, the control mode will recover as before voltage failure. If it is the first time the device is used or a newly enabled function page, the control mode after the device is started is in an uncertain state, and it needs to be manually selected at this time.

—Parameter "Room temperature control system"

This parameter is for setting the type of RTC control system, that is, pipe types of fan coil water inlet/outlet. Options:

2 pipes system

4 pipes system

2 pipes system: Shares an inlet and outlet pipe for heating and cooling, that is, both hot and cold water are controlled by a valve.

4 pipes system: Has its own inlet and outlet pipes for heating and cooling, and two valves are needed to control the entry and exit of hot water and cold water respectively.

Parameter "Room temperature operation mode"

This parameter is for setting whether to enable RTC operation mode.

When enable, support 4 modes with comfort, standby, economy and frost/heat protection. Support datatype of 1bit and 1byte, and preset a operation mode when download and voltage recovery.

Parameters as follow are visible when operation mode enabled.

—Parameter "Controller status after download"

This parameter is for setting the operation mode when power on RTC after download. Options:

Comfort mode

Standby mode

Economy mode

—Parameter "Controller status after voltage recovery"

This parameter is for setting the operation mode when power on RTC after voltage recovery.

Options:

Comfort mode

Standby mode

Economy mode

Frost/heat protection

As before voltage failure

—Parameter "Extended comfort mode [0..255,0=inactive]"

This parameter is for setting the extended time of comfort mode. When value >0, activate the extended, and 1 bit object "Extended comfort mode" is visible. Options: **0..255 min**

When object receives telegram 1, comfort mode activation. If receive telegram 1 again during the delay time, the time is retiming. And comfort mode will return to previous operation mode once finish the timing. Exit the comfort mode when a new operation mode in delay time.

Switch operation will quit the timing, and heating/cooling switchover will not.

—Parameter "1 bit object function for operation mode"

This parameter is for setting whether to enable 1 bit objects of operation mode are visible. Corresponding mode activation when objects send telegram 1; Perform standby mode when object values of comfort, economy, protection received from the bus are 0.

—Parameter "1 bit object for standby mode"

This parameter is visible when previous parameter enabled. Set whether to enable 1 bit object of standby mode is visible.

Parameters as follow are visible when operation mode disabled.

—Parameter “Initial setpoint temperature (°C)”

This parameter is for setting the initial value of setpoint temperature. Options:

10.0

10.5

...

35.0

When initial setpoint temperature is less than the min. setpoint temperature, display following warning:

 The setpoint is less than minimum,so minimum will regard as setpoint in fact

When initial setpoint temperature is greater than the max. setpoint temperature, display following warning:

 The setpoint is greater than maximum,so maximum will regard as setpoint in fact

Automatic H/C mode changeover dead zone

—Parameter “ Upper/Lower dead zone”

These two parameters are visible when control mode“Heating and Cooling” is selected, and “Automatic changeover” is selected. Setting the dead zone range of auto switchover heating/cooling.

Options:

0.5K

1.0K

...

10K

Under heating control, when the actual temperature(T) > or = the setpoint temperature + the upper dead zone, then mode heating switch to cooling;

Under cooling control, when the actual temperature(T) < or = the setpoint temperature + the upper dead zone, then mode cooling switch to heating.

Parameter “Fan speed auto control function”

This parameter is for setting whether to enable fan auto control interface is visible.

Parameter “Window contact input function”

This parameter is visible when operation mode enabled. Set whether to link to window contact status.

When window contact input function is enabled, these two parameters as follow are visible:

—Parameter “Delay for window contact [0..65535]s”

This parameter is visible when operation mode and window contact input function are enabled. Set the delay time to window contact detection. That is, when receive a telegram “window open”, the controller will regard that as a valid signal and execute the behaviour after this delay time. Options:

0..65535

—Parameter “Controller mode for open window”

If window status is open, perform corresponding operation according to configuration. (For the operation mode, the Switch and Setpoint temperature, as well as Heating/Cooling mode are recorded in the background if control telegrams are received, and performed after the window is closed. If there is no telegram receiving during timing, return to the mode before the window was opened.) Options:

Economy mode

Frost/heat protection

Parameter “Bus presence detector function”

This parameter is visible when operation mode is enabled. Set whether to link to bus presence detector status.

If presence is detected, enter the comfort mode and it will be restored to original mode after leaving. If there is a telegram/manual operation to adjust the mode during the period, the telegram is logged in the background, and it will be exited comfort mode and restored to the mode after leaving. If there is no telegram receiving during timing, return to original mode. (If receive the presence status cyclically, comfort mode can not be re-triggered, and only can be after leaving.)

Parameter “Trigger telegram of occupied”

This parameter is for setting the external or local presence sensor to trigger telegram of occupied.

Options is related to the number of local presence detector:

External presence sensor

A of local presence 1 begin

B of local presence 1 begin

C of local presence 1 begin

A of local presence 2 begin

A of local presence 3 begin

A of local presence 4 begin

When there is none local presence detector, option is only **External presence sensor**

When the occupied is triggered via local sensor, you can configure the specific telegram when begin presence. **If the selected telegram is not activated, a warning is displayed, for example, select telegram A of presence detector 1 but it is not activated:**

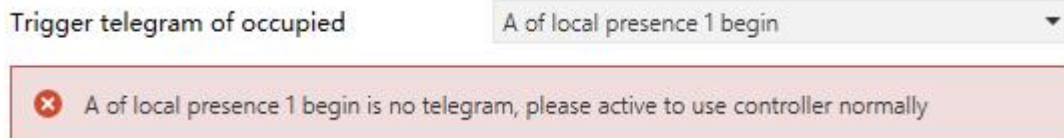

Parameter “Trigger telegram of unoccupied”

This parameter is for setting the external or local presence sensor to trigger telegram of unoccupied.

Options is related to the number of local presence detector:

- External presence sensor**
- D of local presence 1 end**
- E of local presence 1 end**
- F of local presence 1 end**
- D of local presence 2 end**
- D of local presence 3 end**
- D of local presence 4 end**

When there is none local presence detector, option is only **External presence sensor**

When the unoccupied is triggered via local sensor, you can configure the specific telegram when end presence. **If the selected telegram is not activated, a warning is displayed, for example, select telegram D of presence detector 1 but it is not activated:**

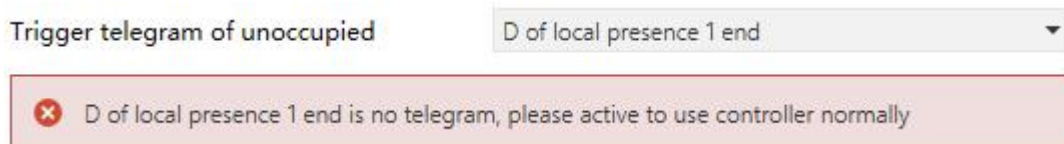

Parameter “Min./Max. setpoint temperature [5..37] ° C”

These parameters are visible when operation mode is disabled. Set to limit the adjustable range of the setpoint temperature, the minimum value should be less than the maximum value. If the setpoint temperature beyond the limited range, the will output the limited temperature. Options:

- 5°C**
- 6°C**
- ...**
- 37°C**

For setpoint temperature, the Min. value must less than the Max., if not, it can not be configured on ETS.

These two parameters are display below the parameters settings interface “Setpoint” when operation mode is enabled.

5.7.1. Parameter window “Setpoint”

--- KNX Presence Sensor, Microwave > RTC function > Setpoint

<ul style="list-style-type: none"> KNX Secure General Internal sensor measurement Presence function Light control Constant lighting RTC function Setpoint Heating control Fan auto. control Logic function Scene Group function 	<p>Setpoint method for operating mode <input checked="" type="radio"/> Relative <input type="radio"/> Absolute</p> <p>Base setpoint temperature 20.0 °C</p> <p>Additional setpoint offset for setpoint adjustment <input type="radio"/> Disable <input checked="" type="radio"/> Enable</p> <p>Step of setpoint offset <input checked="" type="radio"/> 0.5K <input type="radio"/> 1K</p> <p>Min. setpoint offset [-10..0] -5 K</p> <p>Max. setpoint offset [0..10] 5 K</p> <hr/> <p>Heating</p> <p>Reduced heating in standby mode [0..10] 2 K</p> <p>Reduced heating in economy mode [0..10] 4 K</p> <p>Setpoint temperature in frost protection mode [5..10] 7 °C</p> <hr/> <p>Min. setpoint temperature [5..37] 16 °C</p> <p>Max. setpoint temperature [5..37] 32 °C</p>
--	---

Parameter setting of relative adjustment

<ul style="list-style-type: none"> KNX Secure General Internal sensor measurement Presence function Light control Constant lighting RTC function Setpoint Heating/Cooling control Fan auto. control Logic function Scene Group function 	<p>Setpoint method for operating mode <input type="radio"/> Relative <input checked="" type="radio"/> Absolute</p> <p>Heating</p> <p>Setpoint temperature in comfort mode [5..37] 21 °C</p> <p>Setpoint temperature in standby mode [5..37] 19 °C</p> <p>Setpoint temperature in economy mode [5..37] 17 °C</p> <p>Setpoint temperature in frost protection mode [5..10] 7 °C</p> <p>Cooling</p> <p>Setpoint temperature in comfort mode [5..37] 23 °C</p> <p>Setpoint temperature in standby mode [5..37] 25 °C</p> <p>Setpoint temperature in economy mode [5..37] 27 °C</p> <p>Setpoint temperature in heat protection mode [30..37] 35 °C</p> <div style="border: 1px solid #ccc; padding: 5px; margin: 10px 0;"> <p>i Note: The heating setpoint must be always less than the cooling setpoint.</p> </div> <hr/> <p>Min. setpoint temperature [5..37] 16 °C</p> <p>Max. setpoint temperature [5..37] 32 °C</p>
--	--

Parameter setting of absolute adjustment
 Fig.5.7.1 “Setpoint” parameter window

Parameters of this window are visible when RTC operation mode enabled, display according to control mode.

Parameter "Setpoint method for operating mode"

This parameter is for setting the setpoint method for operating mode. Options:

Relative

Absolute

Relative: Relative adjustment, the setting temperature of economy mode and standby mode will refer to the defined temperature setpoint.

Absolute: Absolute adjustment, each mode has its independent temperature setpoint.

Parameters as follow are visible when the setpoint temperature adopts the relative adjustment method.

Parameter "Base setpoint temperature (° C)"

This parameter is for setting the basic setpoint temperature, from which the initial setpoint temperature of the room comfort mode is obtained. Options:

10.0

10.5

...

35.0

The setpoint value will be modified through object "Base setpoint adjustment", then the new value will be stored after the device power off.

When base setpoint temperature is less than the min. setpoint temperature, display following warning:

 The setpoint is less than minimum,so minimum will regard as setpoint in fact

When base setpoint temperature is greater than the max. setpoint temperature, display following warning:

 The setpoint is greater than maximum,so maximum will regard as setpoint in fact

Current basic setpoint temperature = modified basic setpoint temperature +/- accumulated offset(if existence)

When adjusting the setpoint temperature of current operation mode, the setpoint value will be changed with it, but the relative temperature of each mode is unchanged. Relative temperature of standby, economy and comfort mode is set by the parameters as follows.

Parameter "Additional setpoint offset for setpoint adjustment"

This parameter is for setting whether to enable additional setpoint offset function for setpoint adjustment, mainly used to adjust setpoint temperature by 1 bit object. Options:

Disable

Enable

Increase/decrease offset by 1 bit object "Setpoint offset", adjust the setpoint temperature indirectly, and send offset value to the bus by 2 byte object "Float offset value". Also reset the offset value by 1 bit object "Setpoint offset reset", modified the offset value by 2 byte object "Float offset value". Save the offset value when control mode and operation mode changed.

Three parameters as follow are visible when offset function enabled.

—Parameter "Step of setpoint offset"

This parameter is for setting step value of setpoint offset increased/decreased when receiving telegrams. Telegram 1- increase, telegram 0- decrease. Accumulated offset can be saved when power off. Options:

0.5K

1K

Setpoint temperature of current mode = base temperature + fix offset of mode + accumulated additional offset

Note: Fix offset of mode is the offset of standby and economy modes compared to comfort mode, which is decided by the follow parameters of heating/cooling. Accumulated additional offset is adjusted by 1bit object "Setpoint offset", or directly modified the offset value by 2 byte object "Float offset value".

—Parameter "Min. setpoint offset [-10..0]K"

This parameter is for setting the maximum offset allowed when negative offset (setpoint temperature is decreased). Options: **-10..0**

—Parameter "Max. setpoint offset [0..10]K"

This parameter is for setting the maximum offset allowed when forward offset (setpoint temperature is increased). Options: **0..10**

Automatic H/C mode changeover dead zone (only for comfort mode)

Parameter "Upper/Lower dead zone"

These two parameters are visible when control mode "Heating and Cooling" is selected, and "Automatic changeover" is selected. Setting the dead zone range of auto switchover heating/cooling. Options:

0.5K

1.0K

...

10K

Under heating control, when the actual temperature(T) > or = the setpoint temperature + the upper dead zone, then mode heating switch to cooling;

Under cooling control, when the actual temperature(T) < or = the setpoint temperature + the upper dead zone, then mode cooling switch to heating.

Parameter "Reduced heating in standby mode [0...10]K"

Parameter "Increased cooling in standby mode [0...10]K"

These two parameters are for setting the setpoint of standby mode. Options:

0K

1K

...

10K

Heating: The setpoint of standby mode is the temperature setpoint minus the reference value;

Cooling: The setpoint of standby mode is the temperature setpoint plus the reference value.

Parameter "Reduced heating in economy mode [0...10]K"

Parameter "Increased cooling in economy mode [0...10]K"

These two parameters are for setting the setpoint of economy mode. Options:

0K

1K

...

10K

Heating: The setpoint of economy mode is the temperature setpoint minus the reference value;

Cooling: The setpoint of economy mode is the temperature setpoint plus the reference value.

Parameter "Setpoint temperature in frost protection mode [5...10]° C"

This parameter is for setting the setpoint of frost protection mode. Options:

5°C

6°C

...

10°C

Under the frost protection mode, when room temperature reduce to the setpoint, the controller will trigger a control telegram so that related heating controller will output heating control to prevent the temperature from being too low.

Parameter "Setpoint temperature in heat protection mode [30...37]° C"

This parameter is for setting the setpoint of heat protection mode. Options:

30°C

31°C

...
37°C

Under the heat protection mode, when room temperature raise to the setpoint, the controller will trigger a control telegram so that related cooling controller will output cooling control to prevent the temperature from being too high.

Parameters as follow are visible when the setpoint temperature adopts the absolute adjustment method.

Parameter "Setpoint temperature in comfort mode [5...37] ° C"

Parameter "Setpoint temperature in standby mode [5...37] ° C"

Parameter "Setpoint temperature in economy mode [5...37] ° C"

These parameters are for setting the setpoint temperature in comfort, standby and economy mode when heating or cooling. Options:

5°C
6°C
...
37°C

Parameter "Setpoint temperature in frost protection mode [5...10] ° C"

This parameter is for setting the setpoint temperature in frost protection mode when heating.

Options:

5°C
6°C
...
10°C

Parameter "Setpoint temperature in heat protection mode [30...37] ° C"

This parameter is for setting the setpoint temperature in heat protection mode when cooling.

Options:

30°C
31°C
...
37°C

i Note: The heating setpoint must be always less than the cooling setpoint.

For absolute adjustment mode, "Heating and Cooling" and "Automatic changeover" are selected, the note is visible. The heating setpoint value must be less than or equal to the cooling of the same operation mode, if not, it can not be configured on ETS. It is also applied to "Via object"

1. When the ambient temperature is higher than the setpoint temperature of current mode, it is changed to cooling mode; When the ambient temperature is lower than the setpoint temperature of current mode, it is changed to heating mode.

2. In the same operation mode, the setpoint temperature difference between cooling and heating remains constant, whether it is written from the bus or adjusted on the panel. That is, when adjust the setpoint temperature, it need to update cooling and heating setpoint temperature of current operation mode at the same time.

3. For the abnormal configuration where the heating setpoint value is greater than the cooling, it is depend on the setpoint temperature and ambient temperature to adjust heating/cooling mode, that is, change to cooling when ambient temperature is higher than the setpoint temperature in the current operation mode of cooling, while change to heating when ambient temperature is lower than the setpoint temperature in the current operation mode of cooling.

4. When receiving setpoint temperature from bus, it is still necessary to limit the value according to the high and low thresholds, that is heating and cooling temperature neither can not be lower than the min., or can not be higher than the max. If parameters configuration of ETS is not met the condition, it will be noted warnings:

When the setpoint temperature of comfort/standby/economy mode is less than the min. setpoint temperature, display following warning:

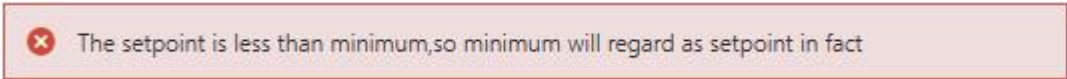

✘ The setpoint is less than minimum, so minimum will regard as setpoint in fact

When the setpoint temperature of comfort/standby/economy mode is greater than the max. setpoint temperature, display following warning:

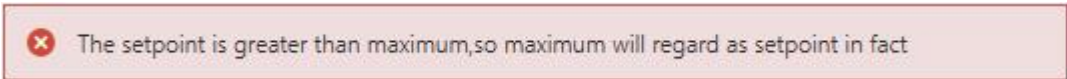

✘ The setpoint is greater than maximum, so maximum will regard as setpoint in fact

Points 2 and 4 also apply to "Via object".

Note: for relative/absolute adjustment, in protection mode, the setpoint temperature is only configured via ETS. When the received setpoint value from bus is different from the ETS configuration, the value is not updated and returned to the current setpoint temperature, to update synchronously to other devices on the bus.

5.7.2. Parameter window “Heating/Cooling control”

--- KNX Presence Sensor, Microwave > RTC function > Heating/Cooling control

<ul style="list-style-type: none"> KNX Secure General Internal sensor measurem... Presence function Light control Constant lighting RTC function Setpoint Heating/Cooling control Fan auto.control Logic function Scene Group function 	<p>Type of heating/cooling control: Switching on/off(use 2-point control)</p> <p>Invert control value: <input type="radio"/> No <input checked="" type="radio"/> Yes</p> <p>Heating</p> <p>Lower Hysteresis [0..200]: 10 *0.1K</p> <p>Upper Hysteresis [0..200]: 10 *0.1K</p> <p>Cooling</p> <p>Lower Hysteresis [0..200]: 10 *0.1K</p> <p>Upper Hysteresis [0..200]: 10 *0.1K</p> <p>Cyclically send control value [0..255]: 10 min</p> <hr/> <p>Additional heating/cooling: <input checked="" type="checkbox"/></p> <p>Control type: <input checked="" type="radio"/> 1bit <input type="radio"/> 1byte</p> <p>Invert control value: <input type="checkbox"/></p> <p>Temperature difference to switch on additional heating [-100..-5]: -25 *0.1K</p> <p>Hysteresis to switch off additional heating [-20..-1]: -5 *0.1K</p> <p>Temperature difference to switch on additional cooling [5..100]: 25 *0.1K</p> <p>Hysteresis to switch off additional cooling [1..20]: 5 *0.1K</p> <p>Cyclically send control value [0..255]: 0 min</p>
---	---

Parameter setting of “Switching on/off(use 2-point control)”

<ul style="list-style-type: none"> KNX Secure General Internal sensor measurem... Presence function Light control Constant lighting RTC function 	<p>Type of heating/cooling control: Switching PWM(use PI control)</p> <p>Invert control value: <input type="radio"/> No <input checked="" type="radio"/> Yes</p> <p>PWM cycle time [1..255]: 15 min</p> <p>Heating speed: Hot water heating(5K/150min)</p> <p>Cooling speed: Cooling ceiling (5K/240min)</p> <p>Cyclically send control value [0..255]: 10 min</p> <hr/> <p>Additional heating/cooling: <input type="checkbox"/></p>
---	--

Parameter setting of “Switching PWM(use PI control)”

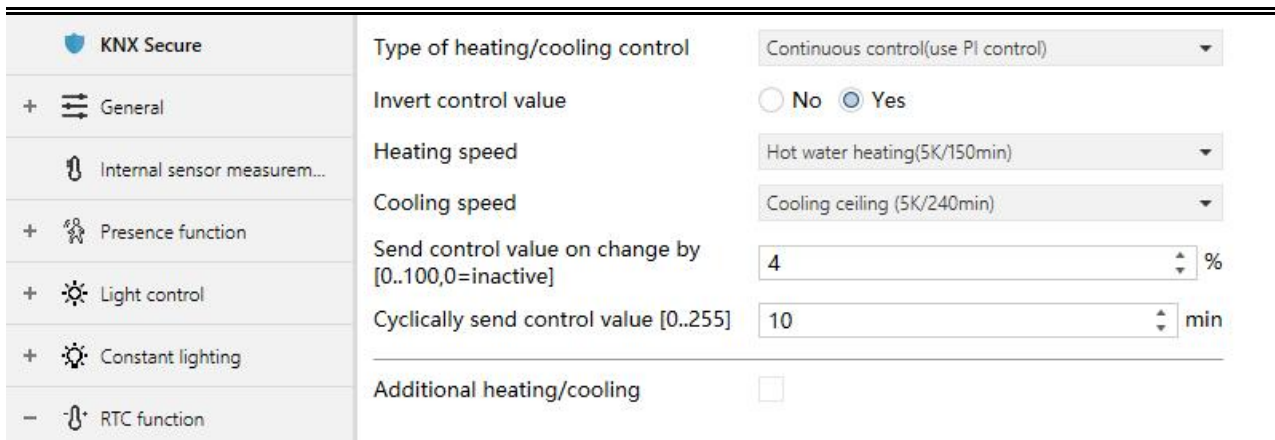

Parameter setting of "Continuous control(use PI control)"
Fig.5.7.2 "Heating/Cooling control" parameter window

Parameters of this window display according to control mode and control system(2 pipe or 4pipe).

Parameter "Type of heating/cooling control"

This parameter is for setting the type of heating/cooling control. Different control types are suitable for controlling different temperature controllers. Options:

Switching on/off(use 2-point control)

Switching PWM(use PI control)

Continuous control(use PI control)

Parameter "Invert control value"

This parameter is for setting whether to invert control value or normal sending control value, so that the control value will be suitable for the valve type. Options:

No

Yes

Yes: Sending the control value to the bus through objects after inverting the control value.

Two parameters as follow are suitable for 2 point control:

—Parameter "Lower Hysteresis [0...200]*0.1K "

—Parameter "Upper Hysteresis [0...200]*0.1K "

These two parameters are for setting the lower/upper hysteresis temperature in HVAC heating or cooling. Options: **0..200**

Under heating control,

When the actual temperature(T) > the setting temperature + the upper hysteresis temperature, then will stop heating;

When the actual temperature(T) < the setting temperature - the lower hysteresis temperature, then will start heating.

For example, the lower hysteresis temperature is 1K, the upper hysteresis temperature is 2K, the setting temperature is 22°C, if T is higher than 24°C, then it will stop heating; if T is lower than 24°C, then it will start heating; if T is between 21~24°C, then it will maintain the previous status.

Under the cooling control,

When the actual temperature (T) < the setting temperature -the lower hysteresis temperature, then will stop cooling;

When the actual temperature (T) > the setting temperature +the upper hysteresis temperature, then will start cooling.

For example, the lower hysteresis temperature is 1K, the upper hysteresis temperature is 2K, the setting temperature is 26°C, if T is lower than 25°C, then it will stop cooling; if T is lower than 28°C, then it will start cooling; if T is between 28~25°C, then it will maintain the previous status.

2-point control mode is a very simple control mode. When adopting this control mode, it is necessary to set the upper hysteresis temperature and the lower hysteresis temperature through parameters. When setting the hysteresis temperature, the following effects need to be considered

1. When hysteresis interval is small, the temperature range will be small, however, frequent sending of control value will bring large load to the bus;
2. When hysteresis interval is large, the switch switching frequency will be low, but it is easy to cause uncomfortable temperature change.

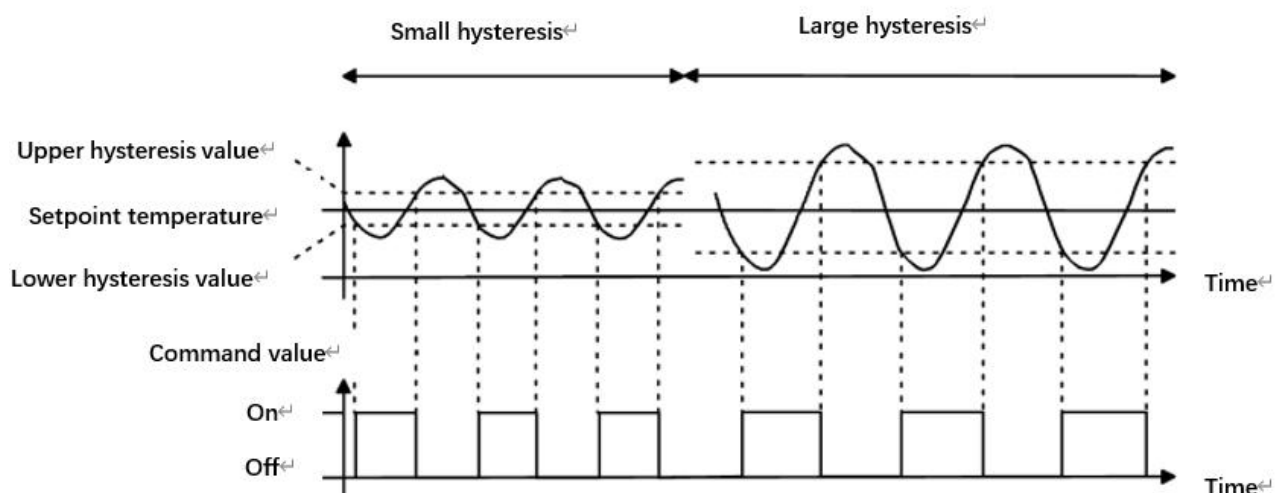

Fig.5.7.2(2) Effects of hysteresis on control value switch action(heating) under2-point control mode

Two parameters as follow are suitable for PI control:

- Parameter "Heating speed"
- Parameter "Cooling speed"

These two parameters are for setting the responding speed of heating or cooling controller. Different responding speeds are suitable for different environments.

Options:

- Hot water heating (5K/150min)
- Underfloor heating (5K/240 min)
- Electrical heating (4K/100min)
- Split unit (4K/90min)
- Fan coil unit (4K/90min)
- User defined

Options

- Cooling ceiling (5K/240min)
- Split unit (4K/90min)
- Fan coil unit(4K/90min)
- User defined

—Parameter “Proportional range [10..100]*0.1K”(P value)

—Parameter “Reset time [0..255]min”(I value)

These two parameters are visible when “User defined” is selected. Set the PI value of PI controller.

Options: **10..100 (P value)**

Options: **0..255 (I value)**

—Parameter “PWM cycle time [1..255]min”

This parameter is only visible when the control type is “Switching PWM(use PI control)”. Set the period of the control object cycle to send the switch value, the object sends the switch value according to the duty cycle of the control value. For example, if the set period is 10 min and the control value is 80%, then the object will send an open telegram for 8 min. If the control value is changed, the time duty ratio of the on/ off telegram of the object will also change, but the period is still the time of parameter setting.

Options: **1..255**

The PI values of “Switching PWM (use PI control)” and “Continuous control (use PI control)” are the same, only different in control objects, the control object of “Continuous control” output PI value(1byte) directly, while the control value of “Switching PWM” output a “on/off” telegram according to the duty cycle of the control value.

—Parameter “Send control value on change by [0..100,0=inactive]”

This parameter is visible when control type is “Continuous control (use PI control)”, for setting the changing value of the control value to be sent to the bus. Options: **0..100, 0=inactive**

Parameter “Cyclically send control value [0..255]min”

This parameter is for setting the period for cyclically sending the control value to the bus.

Options: 0..255

In PI control mode, the predefined control parameters of each PI controller in heating or cooling system are recommended as follows:

(1) Heating

Heating type	P value	I value(integration time)	Recommended PI control type	Recommended PWM period
Hot water Heating	5K	150min	Continuous/PWM	15min
Underfloor heating	5K	240min	PWM	15-20min
Electrical heating	4K	100min	PWM	10-15min
Split unit	4K	90min	PWM	10-15min
Fan coil unit	4K	90min	Continuous	--

(2) Cooling

Cooling type	P value	I value(integration time)	Recommended PI control type	Recommended PWM period
Cooling ceiling	5K	240min	PWM	15-20min
Split unit	4K	90min	PWM	10-15min
Fan coil unit	4K	90min	Continuous	--

(3) User defined

When the parameter "Heating/Cooling speed" is set to "User defined", the parameter value of P (scale factor) and I (integration time) can be set through the parameter. When adjusting the parameters, refer to the fixed PI value mentioned in the above table. Even if the control parameters are adjusted slightly, the control behavior will be significantly different.

In addition, the integration time should be set properly. If the integration time is too long, the adjustment will be slow, and the oscillation will not be obvious; if the integration time is too small, the adjustment will be fast, but the oscillation will occur. 0 means the integral term is not used.

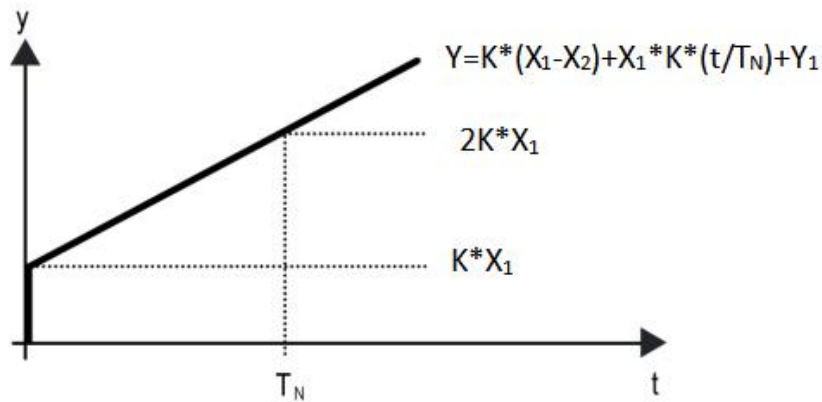

Fig.5.7.2 (3) control value of PI control mode

Y: control value

Y1: last control value

X1: temperature deviation = set temperature - actual temperature

X2: last temperature deviation = set temperature - actual temperature

T_N: integration time

K: scale factor (the scale factor is not zero)

PI control algorithm: $Y = K * (X1-X2) + X1 * K * t / T_N + Y1$

When the integration time is set to zero, the PI control algorithm is: $Y = K (X1-X2) + Y2$

Setting and influence of user-defined parameters:

Parameter setting	Effect
K: If the scale range is too small	Quick adjustment, and overshoot will occur
K: If the scale range is too small	Slow adjustment, but no overshoot
T _N : If the integration time is too short	Quick adjustment, but there will be oscillation
T _N : If the integration time is too long	Slow adjustment, no obvious oscillation

Parameter "Additional heating/cooling"

This parameter is for setting whether to activate additional control of heating/cooling valve. The control is applied to *Two valve unit in one system*, and is used to increase response of temperature control via additional coil system.

Following parameters are visible after additional control is activated:

Parameter "Control type"

This parameter is for setting the object datatype of control value for additional heating/cooling valve. Options:

Parameter "Invert control value"

This parameter is for setting whether to invert control value or normal sending control value, so that the control value will be suitable for the valve type.

For additional heating valve:

Parameter "Temperature difference to switch on additional heating [-100..-5]"

This parameter is for setting the temperature difference value to switch on additional heating.

Options: **-100...-5 *0.1K**

Parameter "Hysteresis to switch off additional heating [-20..-1]"

This parameter is for setting the hysteresis valve to switch off additional heating.

Options: **-20...-1 *0.1K**

When the actual temperature (T) < (Setpoint temperature + Temperature difference), start heating.

When the actual temperature (T) > (Setpoint temperature + Temperature difference - Hysteresis), then will stop heating.

For example, the temperature difference is -10K, the hysteresis is -2K, the setting temperature is 25°C, if T is lower than 15°C, then it will start heating; if T is higher than 17°C, then it will stop heating; if T is between 15~17°C, then it will maintain the previous status.

Note: |Hysteresis| < |Temperature difference|, if not meet the condition, they can not be configured in ETS, and display red box warning, as shown as follow:

Temperature difference to switch on additional heating [-100..-5]	<input style="border: 2px solid red;" type="text" value="-9"/>	*0.1K
Hysteresis to switch off additional heating [-20..-1]	<input type="text" value="-10"/>	*0.1K

For additional cooling valve:**Parameter“Temperature difference to switch on additional cooling [5..100]”**

This parameter is for setting the temperature difference value to switch on additional cooling.

Options: **5..100 *0.1K**

Parameter“Hysteresis to switch off additional cooling [1..20]”

This parameter is for setting the hysteresis valve to switch off additional **cooling**.

Options: **1..20 *0.1K**

When the actual temperature (T) > (Setpoint temperature + Temperature difference), start cooling.

When the actual temperature (T) < (Setpoint temperature + Temperature difference - Hysteresis), then will stop cooling.

For example, the temperature difference is 10K, the hysteresis is 5K, the setting temperature is 15°C, if T is higher than 25°C, then it will start cooling; if T is lower than 20°C, then it will stop cooling; if T is between 20~25°C, then it will maintain the previous status.

Note: |Hysteresis| < |Temperature difference|, if not meet the condition, they can not be configured in ETS, and display red box warning, as shown as follow:

Temperature difference to switch on additional cooling [5..100]	<input type="text" value="19"/>	*0.1K
Hysteresis to switch off additional cooling [1..20]	<input type="text" value="20"/>	*0.1K

Parameter“Cyclically send control value [0...255]”

This parameter is for setting the period for cyclically sending the additional control value to the bus. Options: **0..255 min**

5.7.3. Parameter window “Fan auto.control”

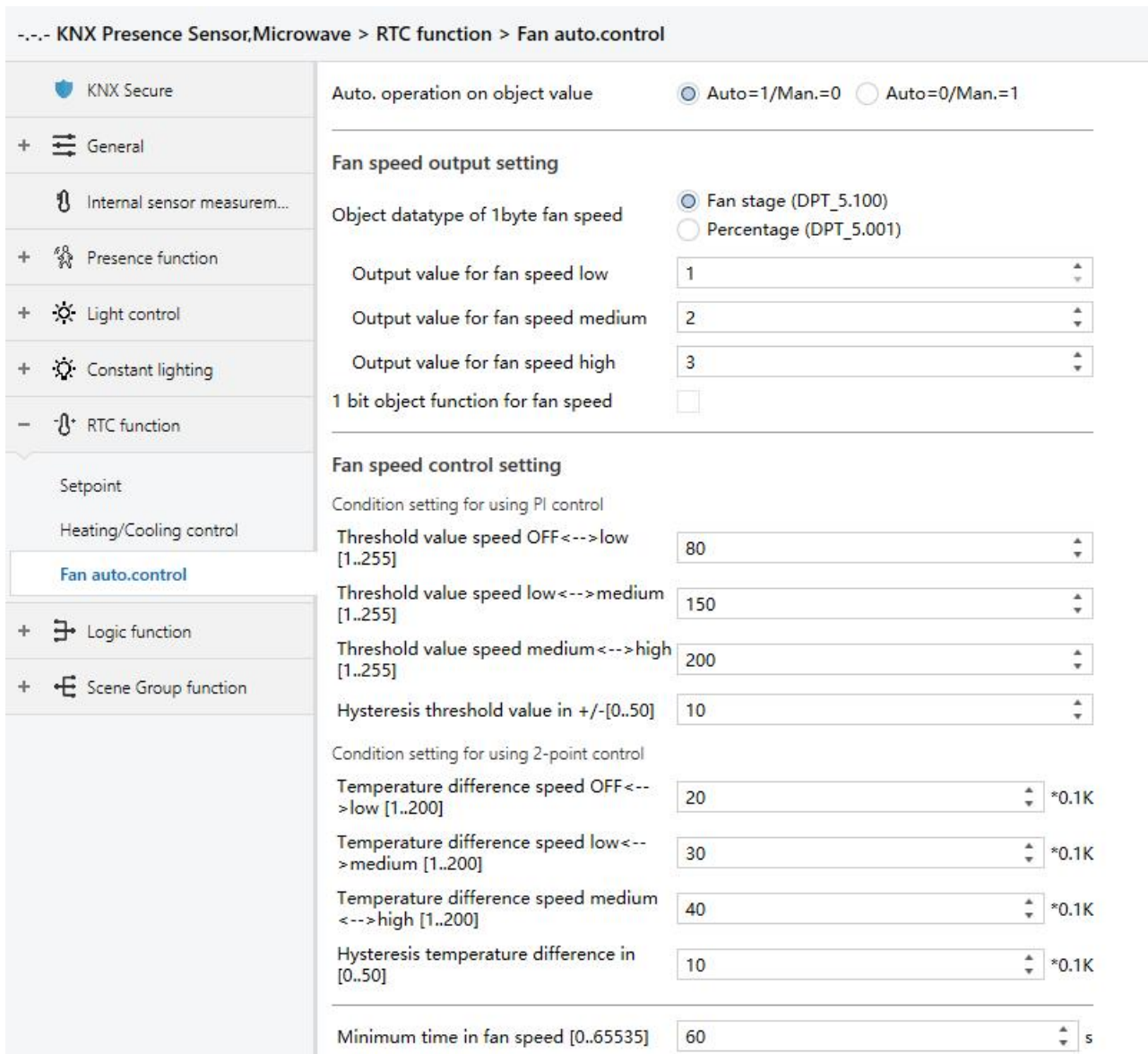

Fig.5.7.3 “Fan auto.control” parameter window

Parameters of this window are visible when fan auto control enabled.

Parameter “Auto. operation on object value”

This parameter is for setting the telegram value to activate automatic operation. Options:

Auto=1/Man.=0

Auto=0/Man.=1

Auto=1/Man.=0: When the object “Fan automatic operation” receives the telegram value “0”, activate the automatic operation, when receive “1”, exit the automatic operation.

Auto=0/Man.=1: When the object “Fan automatic operation” receives the telegram value “1”, activate the automatic operation, when receive “0”, exit the automatic operation.

After power-on, automatic operation is not activated by default.

Fan speed output setting

Parameter "Object datatype of 1byte fan speed"

This parameter is for setting the object datatype of 1 byte fan speed. Options:

Fan stage (DPT 5.100)

Percentage (DPT 5.001)

Parameter "Output value for fan speed low/medium/high"

These three parameters are for setting the value sent for each fan speed switchover. Fan speed off when value is 0. Options according to fan object datatype: **1..255 /1..100**

Note: the out value and status value must meet the condition low<medium<high, if not, they can not be configured on ETS, and display red box warning, as shown as follow:

Output value for Fan speed low	68	%
Output value for Fan speed medium	67	%
Output value for Fan speed high	100	%

Parameter "1 bit object function for fan speed"

This parameter is for setting whether to enable 1 bit object function for fan speed. 1 bit control objects of each fan speed are visible when enabled.

Parameter "1 bit object for fan speed off "

This parameter is visible when previous parameter is enabled. Set whether to enable 1 bit object of fan speed off .

Fan speed control setting

Condition setting for using PI control

Under PI control, control value is PI operated within program, controller will power on/off fan or switch fan speed according to the threshold range of the control values.

Parameter "Threshold value speed OFF<-->low [1..255]"

Define threshold value for off-fan and low-level fan speeds, options: **1..255**

If the control value is greater than or equal to this setting threshold value, low-level fan speed will start running; if the control value is less than this setting threshold value, the fan will be turned off.

Parameter "Threshold value speed low<-->medium [1..255]"

Define the threshold value for switching the fan speed to medium fan speed, if the control value is greater than or equal to this setting threshold, the medium fan speed will start running. Options: **1..255**

Parameter "Threshold value speed medium<-->high [1..255]"

Define the threshold for switching the fan speed to high fan speed, if the control value is greater

than or equal to this setting threshold, the high fan speed will start running. Options: **1..255**

Tip: The controller evaluates the threshold in ascending order.

First check →OFF ↔low fan speed threshold →low fan speed ↔medium fan speed →medium fan speed ↔high fan speed.

The correctness of functional execution is guaranteed only in this case:

The threshold of OFF ↔ low fan speed is lower than that of low fan speed ↔ medium fan speed, and the threshold of low fan speed ↔ medium fan speed is lower than that of medium fan speed ↔ high fan speed. If not, they can not be configured on ETS, and display red box warning, as shown as follow:

Threshold value speed OFF↔low [1..255]	<input style="border: 2px solid red;" type="text" value="150"/>
Threshold value speed low↔ >medium [1..255]	<input type="text" value="150"/>
Threshold value speed medium↔ >high [1..255]	<input type="text" value="200"/>

Parameter "Hysteresis threshold value in +/-[0..50]"

This parameter is for setting the hysteresis value of the threshold value, which can avoid the unnecessary action of the fan when the control value fluctuates near the threshold. Options: **0..50**

If value is 0, no hysteresis. Fan switch to speed once control value greater than threshold value;

Suppose that hysteresis value is 10 and the threshold is 50, then the upper limit threshold 60 (Threshold value+Hysteresis value) and the lower limit threshold 40 (Threshold value-Hysteresis value). When the control value is between 40 ~60, fan action will not be caused, and the previous status will still be maintained. Only less than 40 or greater than or equal to 60 will change the running status of the fan.

Condition setting for using 2-point control

Under 2-point control, controller will decide the fan power on/off or fan speed according to the temperature difference between the actual temperature and setpoint temperature.

Cooling: Temperature difference = actual temperature - setpoint temperature;

Heating: Temperature difference = setpoint temperature - actual temperature.

Parameter "Temperature difference speed OFF↔low [1..200] *0.1K"

This parameter is for setting the temperature difference between off-fan and low-level fan speeds.

Options: **1..200**

If the temperature difference is greater than or equal to this setting temperature difference,

low-level fan speed will start running; if less than this setting temperature difference, the fan will be turned off.

Parameter "Temperature difference speed low<-->medium [1..200]*0.1K"

Define the temperature difference for switching the fan speed to medium fan speed, if the control value is greater than or equal to this setting temperature difference, the medium fan speed will start running.

Options: **1..200**

Parameter "Temperature difference speed medium<-->high [1..200]*0.1K"

Define the temperature difference for switching the fan speed to high fan speed, if the control value is greater than or equal to this setting temperature difference, the high fan speed will start running. Options: **1..200**

Parameter "Hysteresis temperature difference in [0..50] *0.1K"

This parameter is for setting the hysteresis value of the temperature difference, which can avoid the unnecessary action of the fan when the control value fluctuates near the temperature difference.

Options: **0..50**

If value is 0, no hysteresis. Fan switch to speed once control value greater than temperature difference;

Suppose that hysteresis value is 0.5°C and the temperature difference is 1°C, then the upper limit temperature difference 1.5°C (Temperature difference+Hysteresis value) and the lower limit temperature difference 0.5°C (Temperature difference-Hysteresis value). When the control value is between 0.5°C~1.5°C, fan action will not be caused, and the previous status will still be maintained. Only less than 0.5°C or greater than or equal to 1.5°C will change the running status of the fan.

Parameter "Minimum time in fan speed [0..65535]s"

Defines the residence time of the fan from the current fan speed to a higher fan speed or lower fan speed, that is, the minimum time for a fan speed operation.

If you need to switch to another fan speed, you need to wait for this period of time before switching.

If the current fan speed has been running long enough, the fan speed can be changed quickly.

Options: **0..65535**

0: there is no minimum running time, but the delay switching time of fan speed still needs to be considered.

Note: The residence time for this parameter setting is only enabled in Auto mode.

5.8. Parameter window “Logic”

Parameter window “Logic function” as shown as Fig.5.8, for enable logic function, up to 8 logic functions can be configured.

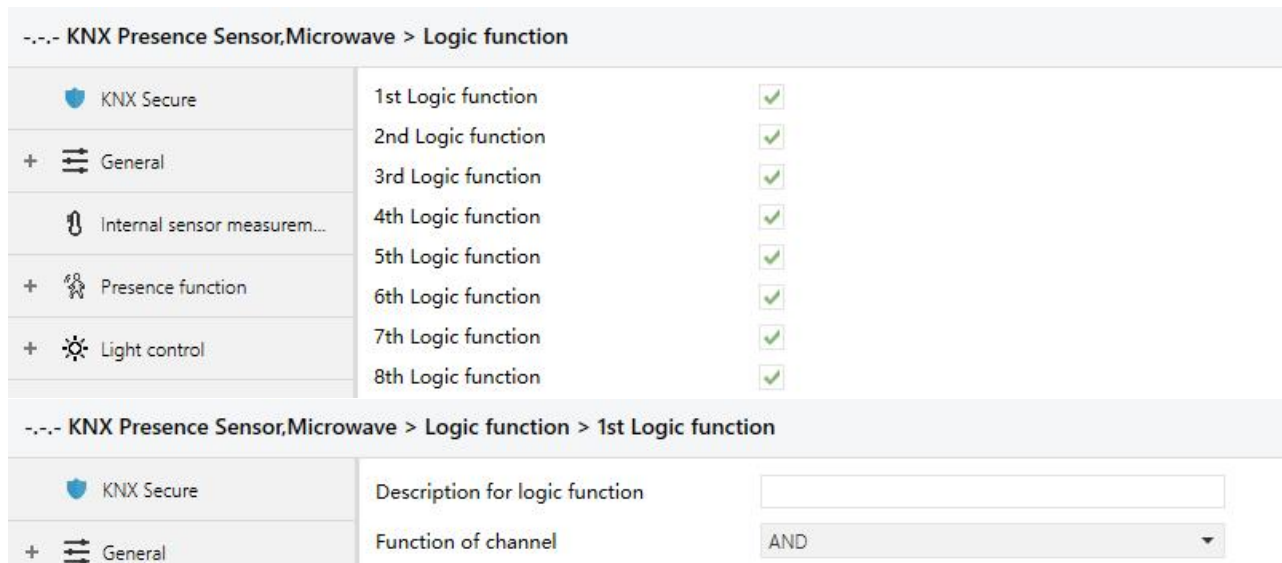

Fig.5.8 “Logic function setting” parameter window

Parameter “1st/2nd/3rd... Logic function”

This parameter is for setting the setting interface of logic function, display corresponding logic function page when select. Up to enable 8 logic functions.

Parameter “Description for logic function”

This parameter is for setting the name description for logic function, up to input 30 characters.

Parameter “Function of channel”

This parameter is for setting function of the channel. Options:

- AND**
- OR**
- XOR**
- Gate forwarding**
- Threshold comparator**
- Format convert**
- Gate function**
- Delay function**
- Staircase lighting**

AND/OR/XOR: as the parameter is similar to the communication object (only the logic algorithm is different), the following parameters taking one options for example.

5.8.1. Parameter window “AND/OR/XOR”

--- KNX Presence Sensor, Microwave > Logic function > 1st Logic function

KNX Secure	Description for logic function	<input type="text"/>
+ General	Function of channel	AND <input type="text"/>
Internal sensor measurem...	Input a	Disconnected <input type="text"/>
+ Presence function	Default value	<input checked="" type="radio"/> 0 <input type="radio"/> 1
+ Light control	Input b	Disconnected <input type="text"/>
+ Constant lighting	Default value	<input checked="" type="radio"/> 0 <input type="radio"/> 1
+ RTC function	Input c	Disconnected <input type="text"/>
- Logic function	Default value	<input checked="" type="radio"/> 0 <input type="radio"/> 1
1st Logic function	Input d	Disconnected <input type="text"/>
2nd Logic function	Default value	<input checked="" type="radio"/> 0 <input type="radio"/> 1
3rd Logic function	Input e	Disconnected <input type="text"/>
4th Logic function	Default value	<input checked="" type="radio"/> 0 <input type="radio"/> 1
5th Logic function	Input f	Disconnected <input type="text"/>
6th Logic function	Default value	<input checked="" type="radio"/> 0 <input type="radio"/> 1
7th Logic function	Input g	Disconnected <input type="text"/>
8th Logic function	Default value	<input checked="" type="radio"/> 0 <input type="radio"/> 1
+ Scene Group function	Input h	Disconnected <input type="text"/>
	Default value	<input checked="" type="radio"/> 0 <input type="radio"/> 1
	Result is inverted	<input checked="" type="radio"/> No <input type="radio"/> Yes
	Read input object value after bus voltage recovery	<input checked="" type="radio"/> No <input type="radio"/> Yes
	Output send when	<input checked="" type="radio"/> Receiving a new telegram <input type="radio"/> Every change of output object
	Send delay time: Base	None <input type="text"/>
	Factor: 1..255	1 <input type="text"/>

Fig.5.8.1 “AND/OR/XOR” parameter window

Parameter “Input a/b/c/d/e/f/g/h”

This parameter is for setting whether input x to calculate, whether to normally calculate or inverted calculate. Options:

Disconnected

Normal

Inverted

Disconnected: not to calculate;

Normal: to directly calculate the input value;

Inverted: invert the input value, then to calculate. **Note: not to invert the initiate value.**

Parameter "Default value"

This parameter is for setting the initial value of logic input x. Options:

0

1

Parameter "Result is inverted"

This parameter is for setting whether to invert the logic calculation result. Options:

No

Yes

No: output directly;

Yes: output after inverting.

Parameter "Read input object value after voltage recovery"

This parameter is for setting whether to send the read request to the logic input object after device voltage recovery or finish programming. Options:

No

Yes

Parameter "Output send when"

This parameter is for setting the condition of sending logic result. Options:

Receiving a new telegram

Every change of output object

Receiving a new telegram: every time the object received a new input value will the logic result be sent to the bus;

Every change of output object: only when logic result has changed will it be sent to the bus.

Tip: when in the first time to logic calculate, the logic result will be sent even if it has no change.

Parameter "Send delay time"

Base: **None**

0.1s

1s

...

10s

25s

Factor: **1..255**

This parameter is for setting the delay time for sending the logic calculation result to the bus. Delay time = Base × Factor, if option "None" of Base is selected, then there is no delay.

5.8.2. Parameter window “Gate forwarding”

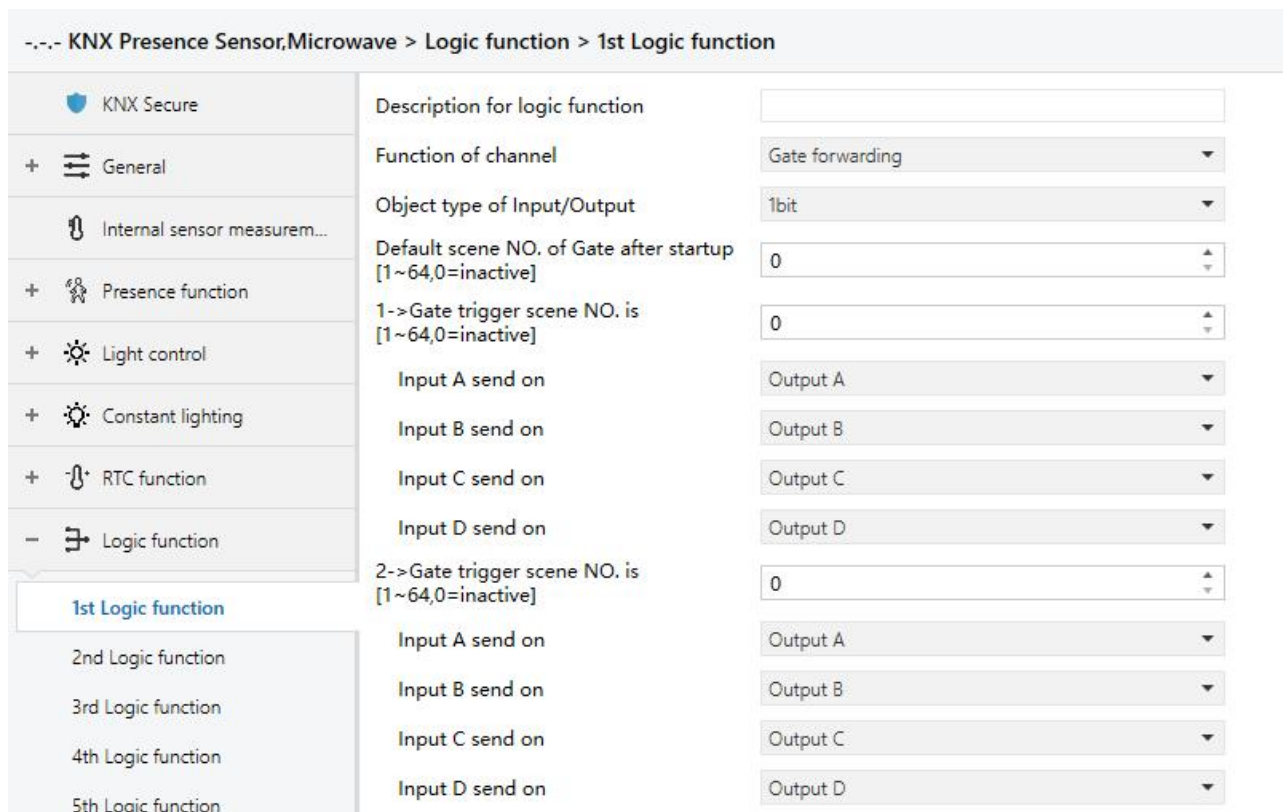

Fig.5.8.2 “Gate forwarding” parameter window

Parameter “Object type of Input/Output”

This parameter is for setting the object type of input/output. Options:

- 1bit**
- 4bit**
- 1byte**

Parameter “Default scene NO. of Gate after startup [1~64,0=inactive]”

This parameter is for setting the initial scene where logical gate forwarding can be performed by default after device starts, which needs to be configured in the parameters. Options: **1..64, 0=inactive**

Note: gate scene is recommended to be selected before operating, or it will enable the initiate scene by default.

Parameter “z->Gate trigger scene NO. is [1~64,0=inactive]” (z=1~8)

This parameter is for setting scene number of logic gate forwarding. Up to 8 trigger scene number can be set for each logic. Options: **1..64, 0=inactive**

Parameter “Input A/B/C/D send on”

This parameter is for setting the output of input X (X=A/B/C/D) after gate forwarding. Options:

- Output A**
- Output B**

...
Output B,C,D

According to the options, one input can be forwarded into one or more outputs, the output value is the same as the input value.

5.8.3. Parameter window “Threshold comparator”

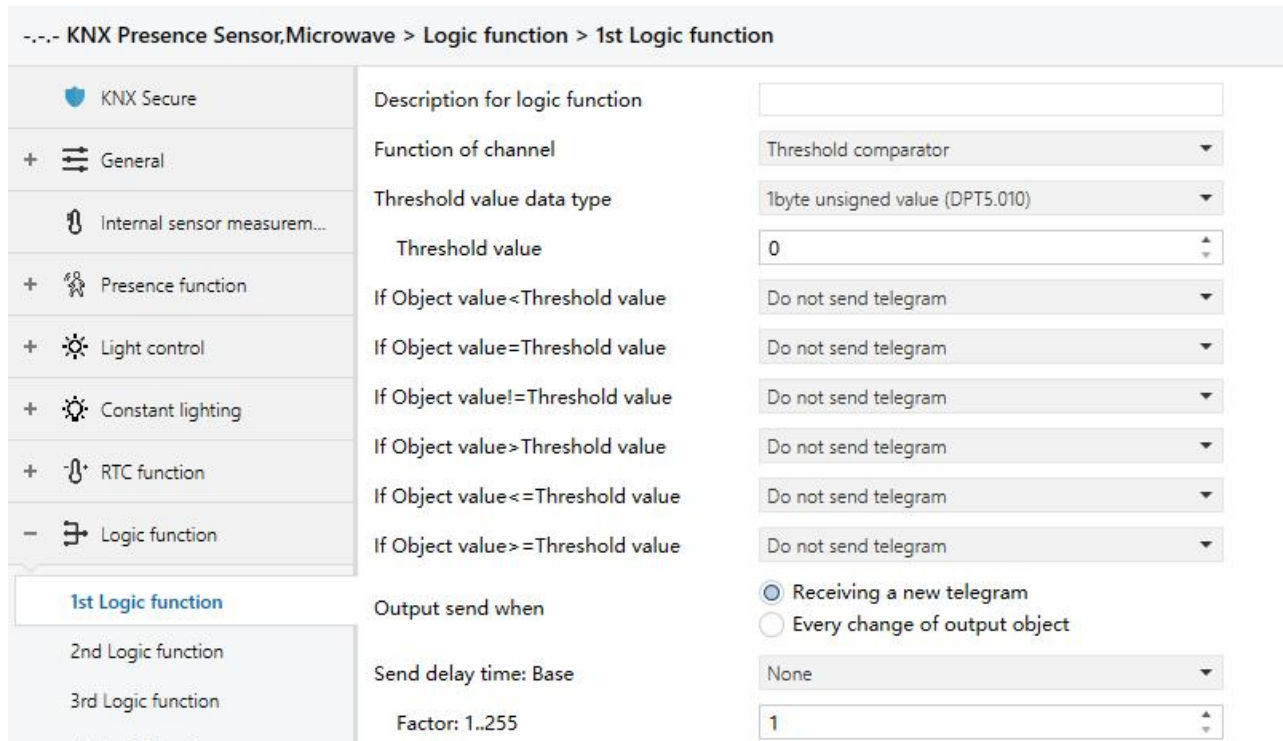

Fig.5.8.3 “Threshold comparator” parameter window

Parameter “Threshold value data type”

This parameter is for setting the threshold value data type. Options:

- | | |
|--|--|
| 4bit value (DPT3.007) | 4byte unsigned value[0..4294967295] |
| 1byte unsigned value (DPT5.010) | Ext. temperature value (DPT 9.001) |
| 2byte unsigned value (DPT7.001) | Ext. humidity value (DPT 9.007) |
| 2byte signed value (DPT8.x) | Illuminance value (DPT 9.004) |
| 2byte float value (DPT9.x) | |

Parameter “Threshold value”

This parameter is for setting threshold value, the range depends on the data type. Options:

- 4bit value (DPT3.007) 0..15 / 1byte unsigned value (DPT5.010) 0..255 /**
2byte unsigned value (DPT7.001) 0..65535 / 2byte signed value (DPT8.x) -32768..32767 /
2byte float value (DPT9.x) -670760...670760 / 4byte unsigned value[0..4294967295]
0..4294967295 /

Ext. temperature value (DPT 9.001) -20..95°C / Ext. humidity value (DPT 9.007) 0..100% /

Illuminance value (DPT 9.004) 0..65535lux

Parameter "Hysteresis threshold value"

This parameter is visible when object datatype is selected "2byte float value (DPT9.x)", "Illuminance value (DPT 9.004)". Set the hysteresis threshold value. Options: **0..500**

Parameter "If Object value<Threshold value"

Parameter "If Object value=Threshold value"

Parameter "If Object value!=Threshold value"

Parameter "If Object value>Threshold value"

Parameter "If Object value<=Threshold value"

Parameter "If Object value>=Threshold value"

This parameter is for setting the logic result value that should be sent when threshold value Less than, equal to, not equal to, greater than, less than or equal to the setting valve. When object datatype is selected "2byte float value (DPT9.x)", can only set the object value less than or greater than threshold value. Options:

Do not send telegram

Send value "0"

Send value "1"

Do not send telegram: not consider to select this option;

Send value "0"/"1": when condition is satisfied, send telegram 0 or1.

If there is a conflict between the setting options between parameters, the base on the value that should be sent when reach the final parameter condition. **For example: parameter "If Object value=Threshold value" is set to be "Send value "0" "; parameter "If Object value<=Threshold value" is set to be "Send value "1" "; when object value is equal to the threshold value, then the logic result will send "1".**

Parameter "Output send when"

This parameter is for setting the condition of sending logic result. Options:

Receiving a new telegram

Every change of output object

Receiving a new telegram: every time the object received a new input value will the logic result be sent to the bus;

Every change of output object: only when logic result has changed will it be sent to the bus.

Tip: when in the first time to logic algorithm, the logic result will be sent even if it has no change.

Parameter "Send delay time"

Base: None

0.1s

1s

...

10s

25s

Factor: 1..255

This parameter is for setting the delay time for sending the logic algorithm result to the bus. Delay time = Base x Factor, if option "None" of Base is selected, then there is no delay.

5.8.4. Parameter window "Format convert"

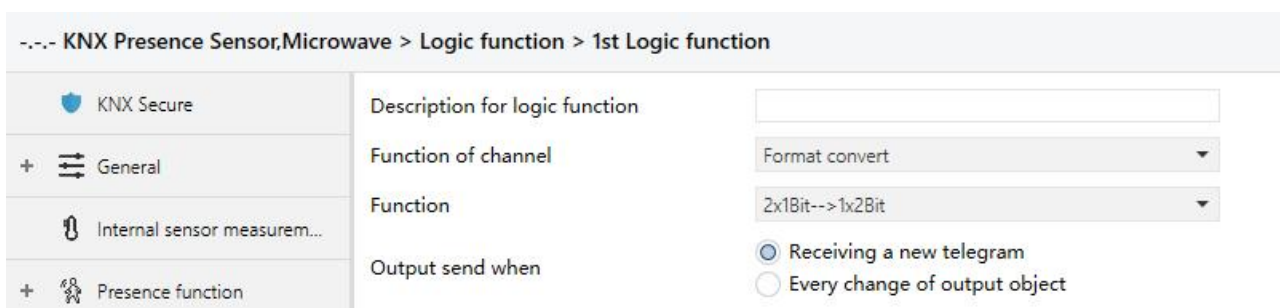

Fig.5.8.4 "Format convert" parameter window

Parameter "Function"

This parameter is for setting the format convert type. Options:

2x1bit-->1x2bit

8x1bit-->1x1byte

1x1byte-->1x2byte

2x1byte-->1x2byte

2x2byte-->1x4byte

1x1byte-->8x1bit

1x2byte-->2x1byte

1x4byte-->2x2byte

1x3byte-->3x1byte

3x1byte-->1x3byte

Parameter "Output send when"

This parameter is for setting the condition of sending logic result. Options:

Receiving a new telegram

Every change of output object

Receiving a new telegram: every time the object received a new input value will the logic result be sent to the bus;

Every change of output object: only when logic result has changed will it be sent to the bus.

Tip: when in the first time to logic algorithm, the logic result will be sent even if it has no change.

5.8.5. Parameter window “Gate function”

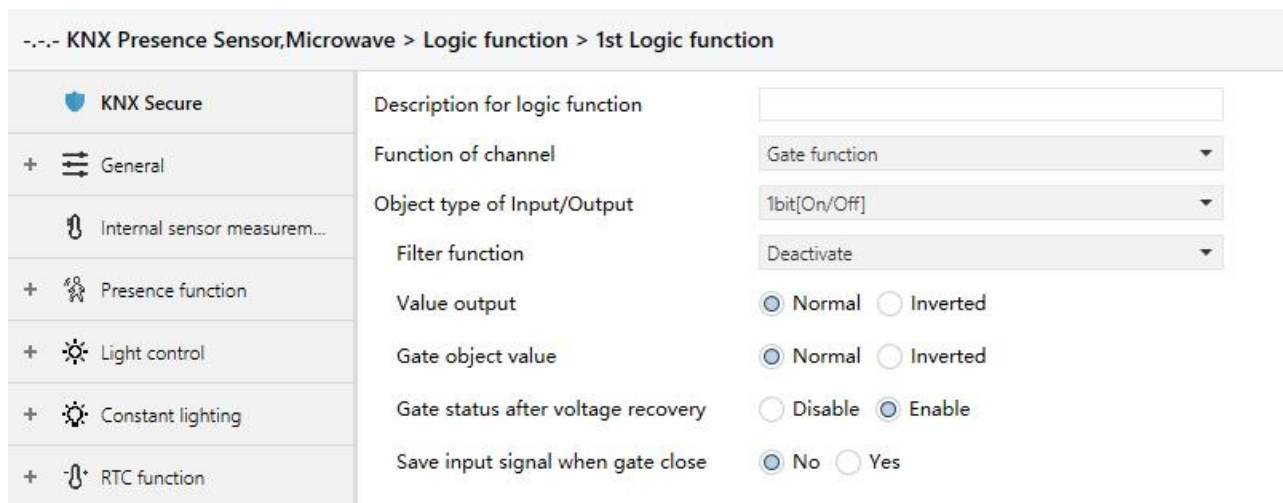

Fig.5.8.5 “Gate function” parameter window

Parameter “Object type of Input/Output”

This parameter is for setting the object type of input/output. Options:

- 1bit[On/Off]**
- 1byte[0..100%]**
- 1byte[0..255]**
- 2byte[Float]**
- 2byte[0..65535]**

Parameter “Filter function”

This parameter is visible when “1bit[On/Off]” is selected. Set whether to filter On or Off telegram, only pass one of them or pass all. Options:

- Deactivate**
- On filter out**
- Off filter out**

Deactivate: Do not filter the On or Off telegrams;

On filter out: Off can pass, On cannot pass;

Off filter out: On can pass, Off cannot pass.

Parameter “Value output”

This parameter is visible when “1bit[On/Off]” is selected. Set whether to invert the value then output it. Options:

- Normal**
- Inverted**

Parameter “Gate object value”

This parameter is for setting whether to invert the gate object value then output it. Options:

- Normal**
- Inverted**

Parameter "Gate status after power on"

This parameter is for setting the gate status after power on. Options:

Disable

Enable

Parameter "Save input signal when gate close"

This parameter is for setting whether to save input signal on gate close. Options:

No

Yes

No: disable to save the input, the input values received during the gate closing period are ignored;

Yes: enable to save the input, the input values received during the gate closing period are output when gate is open (whether the input value is changed or not).

5.8.6. Parameter window "Delay function"

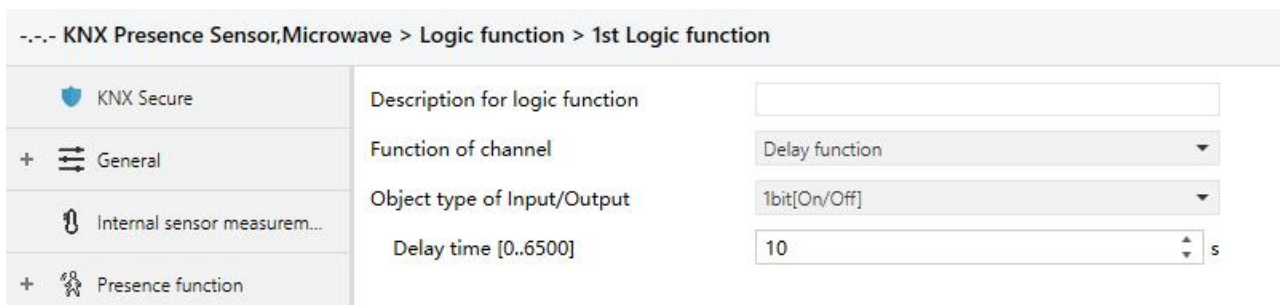

Fig.5.8.6 "Delay function" parameter window

Parameter "Object type of Input/Output"

This parameter is for setting the object type of input/output. Options:

1bit[On/Off]

1byte[0..100%]

1byte[0..255]

2byte[Float]

2byte[0..65535]

Parameter "Delay time [0..6500]s"

This parameter is for setting the delay time that output object forwards the value when the input object receives the telegram. Options: **0..6500**

Note: Receive telegram again in delay time, re-timing.

5.8.7. Parameter window “Staircase lighting”

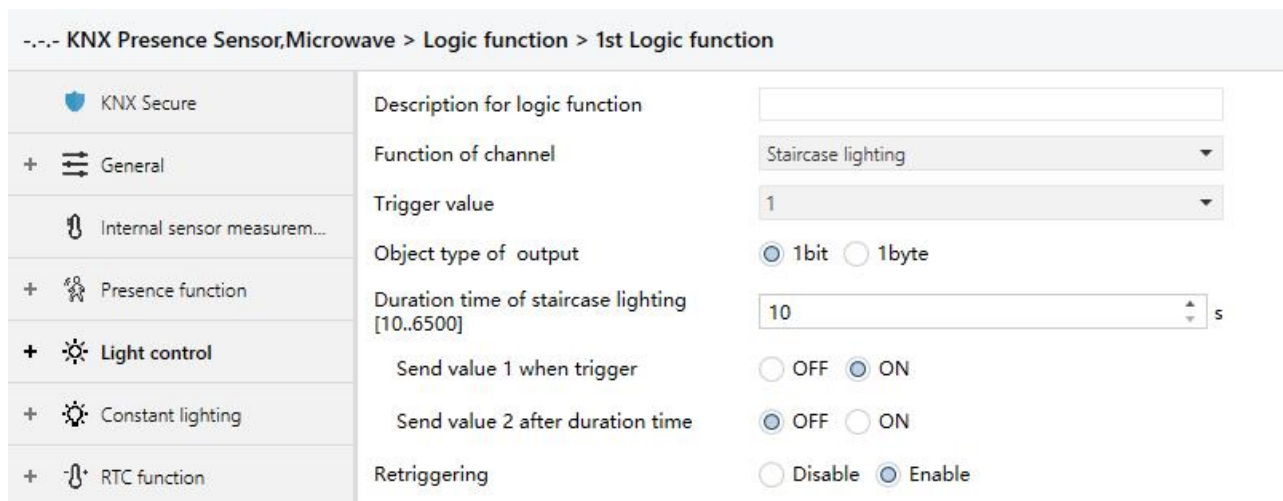

Fig.5.8.7 “Staircase lighting” parameter window

Parameter “Trigger value”

This parameter is for setting the telegram value of the object “Trigger value”. Options:

- 0**
- 1**
- 0 or 1**

Parameter “Object type of output”

This parameter is for setting the object type of output. Options:

- 1bit**
- 1byte**

Parameter “Duration time of staircase lighting[10..6500]s”

This parameter is for setting duration time of staircase lighting after the stair light power on.

Options: **10..6500**

Parameter “Send value 1 when trigger”

Parameter “Send value 2 after duration time”

These parameters are for setting the value to send. Send value 1 when trigger, and then send value 2 after duration time. Options display according to the output object datatype.

When 1 bit, options:

- OFF**
- ON**

When 1 byte , options: **0..255**

Parameter “Retriggering”

This parameter is for setting whether to trigger re-timing when received trigger value in delay time.

Options: **Disable / Enable**

5.9. Parameter window “Scene Group function”

Parameter window “Scene Group function”, for enable scene group setting, up to 8 scene group functions can be configures, there are 8 outputs of each group, as shown as following.

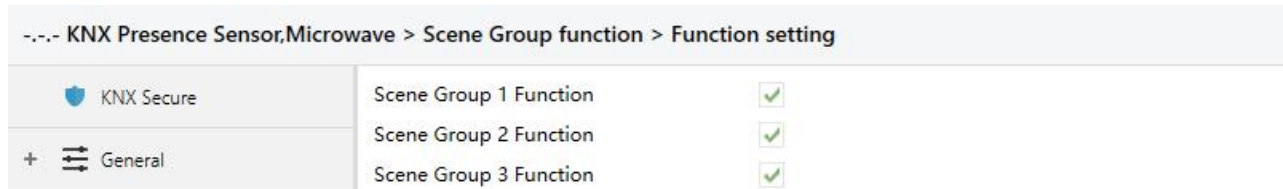

Fig.5.7(1) “Scene Group function” parameter window

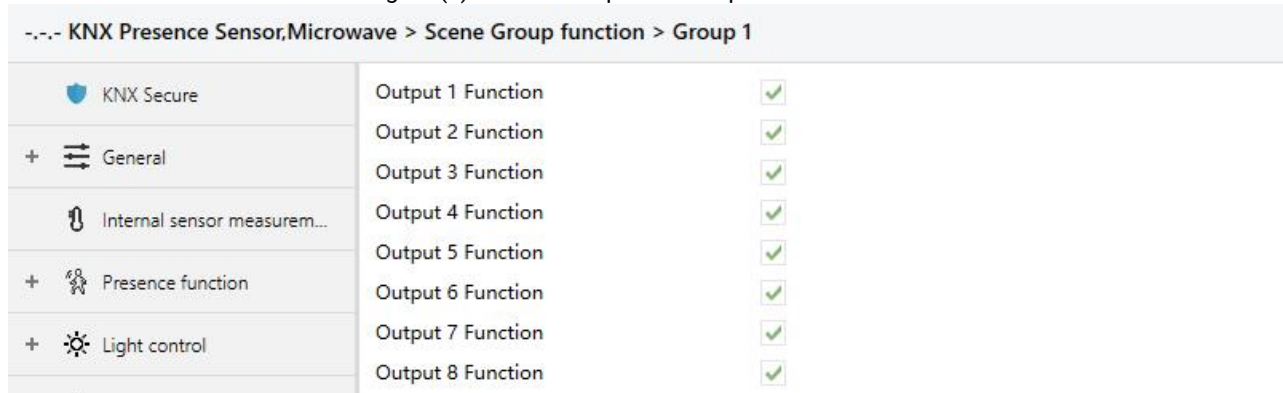

Fig.5.7(2) “Group x” parameter window

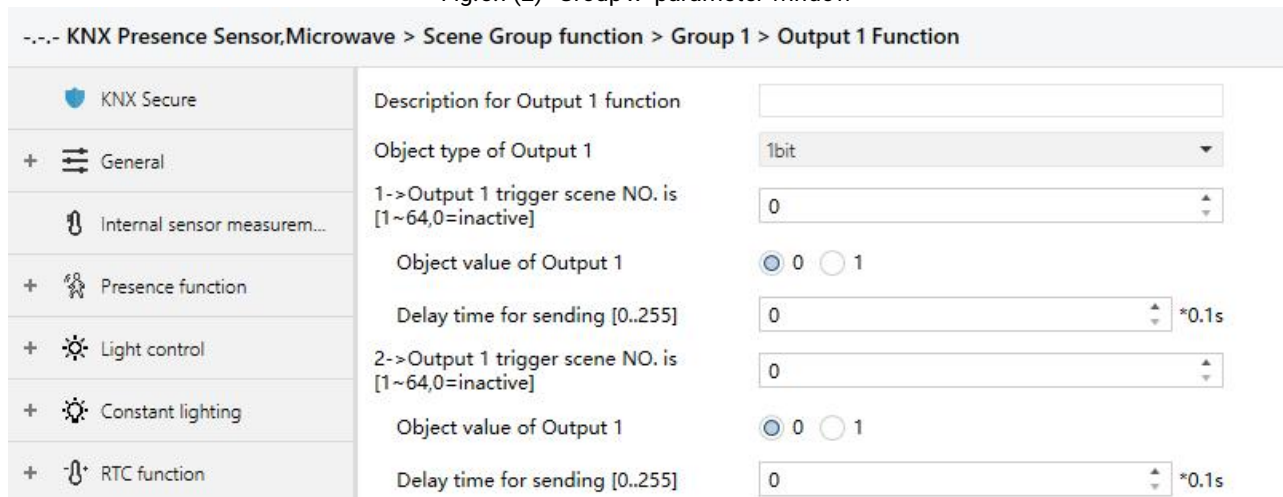

Fig.5.7(3) “Output y Function” parameter window

Parameter “Scene Group x Function”(x=1~8)

This parameter is for setting whether to enable scene group x function, up to 8 scene groups.

Parameter “Output y Function”(y=1~8)

This parameter is for setting whether to enable output y of scene group x, up to 8 output functions for each scene group.

As 8 group functions are the same, and 8 output functions of each group as well, the following description only about one output of a group.

Parameter “Description for Output y function”(y=1~8)

This parameter is for setting the name description for output y of group x, up to input 30

characters.

Parameter "Object type of Output y" (y=1~8)

This parameter is for setting the object type of output y of group x. Options:

- 1bit**
- 1byte**
- 2byte**

Parameter "Object datatype"

This parameter is for setting the datatype of 1byte or 2byte.

When the datatype is 1byte, options:

- 1byte unsigned value**
- HVAC mode**

When the datatype is 2byte, options:

- 2byte unsigned value**
- Temperature value**

Parameter "z->Output y trigger scene NO. is [1~64,0=inactive]" (z=1~8)

This parameter is for setting the triggered scene number of output y of group x. Up to 8 triggered scene of each output can be configured. Options:**0..64, 0=inactive**

Parameter "Object value of Output y"

This parameter is for setting the output value, the range depends on the data type of output y.

When the datatype is 1bit, options: **0..1**

When the datatype is 1byte-1byte unsigned value, options: **0..255**

When the datatype is 1byte-HVAC mode, options:

- Comfort mode**
- Standby mode**
- Economy mode**
- Frost/heat protection**

When the datatype is 2byte-2byte unsigned value, options: **0..65535**

When the datatype is 2byte-Temperature value, options:

- 5°C**
- 4°C**
- ...**
- 45°C**

Parameter "Delay time for sending [0~255]*0.1s"

This parameter is for setting the delay time for sending the output value to the bus.
Options: **0..255**

Chapter 6 Description of Communication Object

The communication object is the medium to communicate other device on the bus, namely only the communication object can communicate with the bus.

NOTE: “C” in “Flag” column in the below table means enable the communication function of the object; “W” means value of object can be written from the bus; “R” means the value of the object can be read by the other devices; “T” means the object has the transmission function; “U” means the value of the object can be updated.

6.1. “General” Communication Object

Number	Name	Object Function	Description	Group Address	Length	C	R	W	T	U	Data Type	Priority
1	General	In operation			1 bit	C	R	-	T	-	switch	Low
275	Extension function	Night mode			1 bit	C	-	W	T	U	day/night	Low
276	Extension function	LED indicator			1 bit	C	-	W	-	-	switch	Low

Fig.6.1 “General” communication object

NO.	Object Function	Name	Data Type	Flag	DPT
1	In operation	General	1bit	C,R,T	1.001 switch
The communication object is used to periodically send a telegram “1” to the bus to indicate that the device is working properly.					
275	Night mode	Extension function	1bit	C,W,T,U	1.024 day/night
This communication object is used to send day/night status to the bus. Telegram value: 0 --- Day 1 --- Night					
276	LED indicator	Extension function	1bit	C,W	1.001 switch
This communication object is used to activate LED indicator via bus. When “ON/OFF via external object” is selected, telegrams: 1- LED on, 0-LED off When “Flashing via external object” is selected, telegrams: 1- LED flashing, 0-LED off					

Table 6.1 “General” communication object table

6.2. "Internal sensor measurement" Communication Object

Number	Name	Object Function	Description	Group Address	Length	C	R	W	T	U	Data Type	Priority
3	Internal sensor	Brightness value			2 bytes	C	R	-	T	-	lux (Lux)	Low
4	Internal sensor	Brightness correction[-500..500]			2 bytes	C	-	W	-	-	lux (Lux)	Low
5	Internal sensor	Temperature value			2 bytes	C	R	-	T	-	temperature (°C)	Low
8	Internal sensor	Humidity value			2 bytes	C	R	-	T	-	humidity (%)	Low
6	Internal sensor	Low temperature alarm			1 bit	C	R	-	T	-	alarm	Low
7	Internal sensor	High temperature alarm			1 bit	C	R	-	T	-	alarm	Low
9	Internal sensor	Low humidity alarm			1 bit	C	R	-	T	-	alarm	Low
10	Internal sensor	High humidity alarm			1 bit	C	R	-	T	-	alarm	Low

Fig.6.2 "Internal sensor measurement" communication object

NO.	Object Function	Name	Data Type	Flag	DPT
3	Brightness value	Internal sensor	2byte	C,R,T	7.013 brightness(lux) 9.004 lux
The communication object is used to send the brightness value detected by the built-in brightness sensor of the device to the bus. Object datatype and telegram range is depending on parameter.					
4	Brightness correction[-500...500]	Internal sensor	2byte	C,W	8.001 pulse difference
The communication object is used to correct brightness value via bus, range: -500...500 lux, the limit value is taken when the calibration value exceeds the range.					
5	Temperature value	Internal sensor	2byte	C,R,T	9.001 temperature
The communication object is used to send the temperature value detected by the built-in temperature sensor of the device to the bus. Range:-50~99.8°C					
6	Low temperature alarm	Internal sensor	1bit	C,R,T	1.005 alarm
The communication object is used to send the low temperature alarm signal to bus, when temperature lower than low threshold that defined by parameter.					
7	High temperature alarm	Internal sensor	1bit	C,R,T	1.005 alarm
The communication object is used to send the high temperature alarm signal to bus, when temperature higher than high threshold that defined by parameter.					
8	Humidity value	Internal sensor	2byte	C,R,T	9.007 humidity
The communication object is used to receive humidity measurements sent from the humidity sensor on the bus. Range:0~100%					
9	Low humidity alarm	Internal sensor	1bit	C,R,T	1.005 alarm
The communication object is used to send the low humidity alarm signal to bus, when humidity lower than low threshold that defined by parameter.					
10	High humidity alarm	Internal sensor	1bit	C,R,T	1.005 alarm
The communication object is used to send the high humidity alarm signal to bus, when humidity higher than high threshold that defined by parameter.					

Table 6.2 "Internal sensor measurement" communication object table

6.3. "Presence function" Communication Object

Number	Name	Object Function	Description	Group Address	Length	C	R	W	T	U	Data Type	Priority
148	Presence control 1	Slave input			1 bit	C	-	W	T	U	switch	Low
149	Presence control 1	Begin of presence, A			1 bit	C	-	-	T	-	switch	Low
150	Presence control 1	Begin of presence, B			1 bit	C	-	-	T	-	switch	Low
151	Presence control 1	Begin of presence, C			1 bit	C	-	-	T	-	switch	Low
152	Presence control 1	End of presence, D			1 bit	C	-	-	T	-	switch	Low
153	Presence control 1	End of presence, E			1 bit	C	-	-	T	-	switch	Low
154	Presence control 1	End of presence, F			1 bit	C	-	-	T	-	switch	Low
155	Presence control 1	Follow-up time[10..65535]s			2 bytes	C	R	W	-	-	time (s)	Low
156	Presence control 1	External input			1 bit	C	-	W	-	-	trigger	Low
157	Presence control 1	Auto.mode/Semi-Auto. mode			1 bit	C	-	W	-	-	enable	Low
158	Presence control 1	End presence (only off telegram)			1 bit	C	-	W	-	U	switch	Low
159	Presence control 1	Brightness independent			1 bit	C	-	W	-	-	enable	Low
160	Presence control 1	External brightness			2 bytes	C	-	W	T	U	lux (Lux)	Low
161	Presence control 1	Actual brightness			2 bytes	C	R	-	T	-	lux (Lux)	Low
162	Presence control 1	Brightness threshold for presence[1...2000]			2 bytes	C	R	W	T	-	lux (Lux)	Low
163	Presence control 1	Dis/En presence function			1 bit	C	-	W	-	-	enable	Low
164	Presence control 1	Preset output of Dis/En function			1 bit	C	-	-	T	-	switch	Low

Presence function-Master

Number	Name	Object Function	Description	Group Address	Length	C	R	W	T	U	Data Type	Priority
149	Presence control 1	Slave output			1 bit	C	R	-	T	-	switch	Low
158	Presence control 1	End presence (only off telegram)			1 bit	C	-	W	-	-	switch	Low
159	Presence control 1	Brightness independent			1 bit	C	-	W	-	-	enable	Low
160	Presence control 1	External brightness			2 bytes	C	-	W	T	U	lux (Lux)	Low
161	Presence control 1	Actual brightness			2 bytes	C	R	-	T	-	lux (Lux)	Low
162	Presence control 1	Brightness threshold for presence[1...2000]			2 bytes	C	R	W	T	-	lux (Lux)	Low
163	Presence control 1	Dis/En presence function			1 bit	C	-	W	-	-	enable	Low

Presence function-Slave

Fig.6.3 "Presence function" communication object

NO.	Object Function	Name	Data Type	Flag	DPT
148	Slave input	Presence control 1	1bit	C,W,T,U	1.001 switch
<p>The communication object is applied to master type. It is visible when slave input is enabled. Used for slave detector to detect input signal, telegram 1 is valid. Send read request to the slave after bus reset or programming.</p>					
149	Slave output	Presence control 1	1bit	C,R,T	1.001 switch
<p>The communication object is applied to slave type. Used for slave detector to send detection status to the bus.</p>					
149	Begin of presence, A	Presence control 1	1bit 1byte 2byte	C,T	1.001 switch 5.001 percentage 5.010 counter pulses 17.001 scene number 20.102 HVAC mode 9.001 temperature
150	Begin of presence, B	Presence control 1			
151	Begin of presence, C	Presence control 1			
<p>These communication objects are applied to master type. They are not visible when "No telegram" is selected. Used to send the telegram for begin of presence, object datatype and range is depending on the parameters.</p>					

152	End of presence, D	Presence control 1	1bit	C,T	1.001 switch 5.001 percentage 5.010 counter pulses 17.001 scene number 20.102 HVAC mode 9.001 temperature
153	End of presence, E	Presence control 1	1byte		
154	End of presence, F	Presence control 1	2byte		
<p>These communication objects are applied to master type.</p> <p>They are not visible when “No telegram” is selected. Used to send the telegram for end of presence, object datatype and range is depending on the parameters.</p>					
155	Follow-up time[1...65535]s	Presence control 1	2byte	C,W, R	7.005 time(s)
<p>The communication object is applied to master type.</p> <p>Used to modify follow-up time via the bus, the modified range according to parameter define, the limit value is taken when the modified value exceeds the range.</p> <p>And also support to be read, when the device starts, the current Follow-up time is written to the object (restart after download or voltage recovery).</p>					
156	External input	Presence control 1	1bit	C,W	1.017 trigger
<p>The communication object is applied to master type.</p> <p>Used for external input, object value is defined by parameter.</p> <p>When automatic mode, it is used to simulate action of begin or end of presence; when semi-automatic mode, it is used to trigger begin or end of presence.</p>					
157	Auto.mode/Semi-Auto. mode	Presence control 1	1bit	C,W	1.003 enable
<p>The communication object is applied to master type.</p> <p>Used to change to automatic mode or semi-automatic mode, object value is defined by parameter.</p>					
158	End presence (only off telegram)	Presence control 1	1bit	C,W,U C,W	1.001 switch
<p>The communication object is applied to master and slave type. When master type, flag is C,W,U; when slave type, flag is C,W.</p> <p>Used to receive the switch status of actuator, enter dead time when receive telegram OFF, and suppress presence detection, reset the follow-up time. Telegram ON is no meaning.</p>					
159	Brightness independent	Presence control 1	1bit	C,W	1.003 enable
<p>The communication object is applied to master and slave type.</p> <p>Used to set the detector is depending on or independent of brightness via bus, object value is defined by parameter.</p>					
160	External brightness	Presence control 1	2byte	C,W,T,U	9.004 lux(lux)
<p>The communication object is applied to master and slave type.</p> <p>Used to receive brightness of external sensor, and circularly send read request (if configured).</p>					

161	Actual brightness	Presence control 1	2byte	C,R,T	9.004 lux(lux)
<p>The communication object is applied to master and slave type.</p> <p>Used to send brightness value detected by combination of internal and external sensors to the bus.</p>					
162	Brightness threshold for presence[1...2000]	Presence control 1	2byte	C,W,R,T	9.004 lux(lux)
<p>The communication object is applied to master and slave type.</p> <p>Used to modify brightness threshold for presence, the modified range according to parameter define, the limit value is taken when the modified value exceeds the range.</p> <p>And also support to be read, when the device starts, the current brightness threshold value is written to the object (restart after download or voltage recovery).</p>					
163	Dis/En presence function	Presence control 1	1bit	C,W	1.003 enable
<p>The communication object is applied to master and slave type.</p> <p>Used to disable / enable presence function, object value is defined by parameter.</p>					
164	Preset output of Dis/En function	Presence control 1	1bit 1byte 2byte	C,T	1.001 switch 5.001 percentage 5.010 counter pulses 17.001 scene number 7.001 pulses
<p>The communication object is applied to master type.</p> <p>Used to send preset value defined by parameter when parameter "Disable presence function" is enabled. Object datatype and range is depending on the parameters.</p>					

Table 6.3 "Presence function" communication object table

6.4. "Light control" Communication Object

Number	Name	Object Function	Description	Group Address	Length	C	R	W	T	U	Data Type	Priority
216	Light control	External brightness 1			2 bytes	C	-	W	T	U	lux (Lux)	Low
217	Light control	External brightness 2			2 bytes	C	-	W	T	U	lux (Lux)	Low
218	Light control	External brightness 3			2 bytes	C	-	W	T	U	lux (Lux)	Low
219	Light control	Actual brightness			2 bytes	C	R	-	T	-	lux (Lux)	Low
220	Light control	Light control			1 bit	C	-	-	T	-	switch	Low
221	Light control	Lower brightness threshold[1..2000]			2 bytes	C	R	W	-	-	lux (Lux)	Low
222	Light control	Upper brightness threshold[50..2000]			2 bytes	C	R	W	-	-	lux (Lux)	Low
223	Light control	Dis./En. function			1 bit	C	-	W	-	-	enable	Low

Fig.6.4 "Light control" communication object

NO.	Object Function	Name	Data Type	Flag	DPT
216	External brightness 1	Light control	2byte	C,W,T,U	9.004 lux(lux)
217	External brightness 2	Light control	2byte	C,W,T,U	9.004 lux(lux)
218	External brightness 3	Light control	2byte	C,W,T,U	9.004 lux(lux)
<p>These communication objects are visible according to number of external brightness sensor, up to 3 sensors, they are not visible when number is 0. Used to receive brightness value of external sensors, and circularly send read request (if configured).</p>					
219	Actual brightness	Light control		C,R,T	9.004 lux(lux)
<p>The communication object is visible when there are 2 referenced sensors or above. Used to send brightness value detected by combination of sensors to the bus.</p>					
220	Light control	Light control	1bit 1byte	C,T	1.001 switch 17.001 scene number
<p>The communication object is used to send control value according to compare the current brightness with lower and upper threshold. Object datatype and range is depending on the parameters.</p>					
221	Lower brightness threshold[50...2000]	Light control	2byte	C,W, R	9.004 lux(lux)
<p>The communication object is used to modify lower threshold via bus. Note: if the lower threshold is greater than or equal to the upper threshold, ignore this modification.</p> <p>And also support to be read, when the device starts, the current lower brightness threshold value is written to the object (restart after download or voltage recovery).</p>					
222	Upper brightness threshold[1...2000]	Light control	2byte	C,W, R	9.004 lux(lux)
<p>The communication object is used to modify upper threshold via bus. Note: if the upper threshold is lower than or equal to the lower threshold, ignore this modification.</p> <p>And also support to be read, when the device starts, the current upper brightness threshold value is written to the object (restart after download or voltage recovery).</p>					
223	Dis./En. function	Light control	1bit	C,W	1.003 enable
<p>The communication object is used to disable or enable light control function via bus, object value is defined by parameter.</p>					

Table 6.4 "Light control" communication object table

6.5. “Constant lighting” Communication Object

Number	Name	Object Function	Description	Group Address	Length	C	R	W	T	U	Data Type	Priority
224	Constant lighting	External brightness 1			2 bytes	C	-	W	T	U	lux (Lux)	Low
225	Constant lighting	External brightness 2			2 bytes	C	-	W	T	U	lux (Lux)	Low
226	Constant lighting	External brightness 3			2 bytes	C	-	W	T	U	lux (Lux)	Low
227	Constant lighting	Actual brightness			2 bytes	C	R	-	T	-	lux (Lux)	Low
229	Constant lighting	Controller status			1 bit	C	R	-	T	-	switch	Low
230	Constant lighting	Brightness setpoint			2 bytes	C	R	W	T	U	lux (Lux)	Low
231	Constant lighting	Current main dimming value status			1 byte	C	-	W	T	U	percentage (0..100%)	Low
232	Constant lighting	Dimming output for main			1 byte	C	R	-	T	-	percentage (0..100%)	Low
233	Constant lighting	Dimming output for sub 1			1 byte	C	R	-	T	-	percentage (0..100%)	Low
234	Constant lighting	Dimming output for sub 2			1 byte	C	R	-	T	-	percentage (0..100%)	Low
235	Constant lighting	Dimming output for sub 3			1 byte	C	R	-	T	-	percentage (0..100%)	Low
236	Constant lighting	Dimming output for sub 4			1 byte	C	R	-	T	-	percentage (0..100%)	Low
237	Constant lighting	Control stop, switch			1 bit	C	-	W	-	-	switch	Low
238	Constant lighting	Control stop, dimming			4 bit	C	-	W	-	-	dimming control	Low
239	Constant lighting	Control stop, dimming value			1 byte	C	-	W	-	-	percentage (0..100%)	Low

Fig.6.5 “Constant lighting” communication object

NO.	Object Function	Name	Data Type	Flag	DPT
224	External brightness 1	Constant lighting	2byte	C,W,T,U	9.004 lux(lux)
225	External brightness 1	Constant lighting	2byte	C,W,T,U	9.004 lux(lux)
226	External brightness 1	Constant lighting	2byte	C,W,T,U	9.004 lux(lux)
<p>These communication objects are visible according to number of external brightness sensor, up to 3 sensors, they are not visible when number is 0. Used to receive brightness value of external sensors, and circularly send read request (if configured).</p>					
227	Actual brightness	Constant lighting	2byte	C,R,T	9.004 lux(lux)
<p>The communication object is visible when there are 2 referenced sensors or above. Used to send brightness value detected by combination of sensors to the bus.</p>					
228	Controller On/Off	Constant lighting	1bit	C,W	1.001 switch
<p>The communication object is visible when controller is triggered via external object. Used to turn on / off the controller via bus.</p> <p>When receive telegram 0, turn off the controller, that is the setpoint value and actual value are no longer compared, and output brightness 0, so constant lighting control is stopped at this time. When receive telegram 1, turn on the controller.</p>					
229	Controller status	Constant lighting	1bit	C,R,T	1.001 switch
<p>The communication object is used to send controller status, send the telegram when changed. Telegrams:</p> <p>0 — Controller off</p> <p>1 — Controller on</p>					
230	Brightness setpoint	Constant lighting	2byte	C,W,R,T	9.004 lux(lux)
<p>The communication object is used to modify brightness setpoint value via bus, the modified range is defined by parameter, the limited value is taken when exceed the range. Also support to be read (it is convenient for the screen device to display the current setpoint value).</p>					

When the device starts, the current brightness setpoint value is written to the object (restart after download or voltage recovery).					
231	Current master dimming value status	Constant lighting	1byte	C,W,T,U	5.001 percentage
The communication object is used to send a read request to bus when controller is turn on, to read the current status of master dimmer.					
232	Dimming output for main	Constant lighting	1byte	C,R,T	5.001 percentage
The communication object is used to send the dimming value of main device, to control each group brightness.					
233	Dimming output for sub 1	Constant lighting	1byte	C,R,T	5.001 percentage
234	Dimming output for sub 2	Constant lighting	1byte	C,R,T	5.001 percentage
235	Dimming output for sub 3	Constant lighting	1byte	C,R,T	5.001 percentage
236	Dimming output for sub 4	Constant lighting	1byte	C,R,T	5.001 percentage
When main/sub operation is enabled, these communication objects are visible according to number of subs, up to 4 sub devices. Used to send the dimming value of sub devices, to control each group brightness.					
237	Control stop, switch	Constant lighting	1bit	C,W	1.001 switch
238	Control stop, dimming	Constant lighting	4bit	C,W	3.007 dimming
239	Control stop, dimming value	Constant lighting	1byte	C,W	5.001 percentage
These communication objects are visible when stop function is enabled. Controller becomes inactive when receive control telegrams, and send telegram OFF of controller at the same time, but not send output telegrams (that is, maintain the current status).					

Table 6.5 "Constant lighting" communication object table

6.6. “RTC function” Communication Object

Number	Name	Object Function	Description	Group Address	Length	C	R	W	T	U	Data Type	Priority
240	RTC controller	Power on/off			1 bit	C	R	W	-	-	switch	Low
241	RTC controller	External temperature sensor			2 bytes	C	-	W	T	U	temperature (°C)	Low
242	RTC controller	Base setpoint adjustment			2 bytes	C	-	W	-	-	temperature (°C)	Low
243	RTC controller	Setpoint offset			1 bit	C	-	W	-	-	step	Low
244	RTC controller	Float offset value			2 bytes	C	-	W	-	-	temperature differenc...	Low
245	RTC controller	Setpoint offset reset			1 bit	C	-	W	-	-	reset	Low
246	RTC controller	Heating/Cooling mode			1 bit	C	-	W	-	-	cooling/heating	Low
247	RTC controller	Operation mode			1 byte	C	-	W	-	-	HVAC mode	Low
248	RTC controller	Comfort mode			1 bit	C	-	W	-	-	enable	Low
249	RTC controller	Economy mode			1 bit	C	-	W	-	-	enable	Low
250	RTC controller	Frost/Heat protection mode			1 bit	C	-	W	-	-	enable	Low
251	RTC controller	Standby mode			1 bit	C	-	W	-	-	enable	Low
253	RTC controller	Fan automatic operation			1 bit	C	-	W	-	-	enable	Low
254	RTC controller	Window contact			1 bit	C	-	W	-	U	window/door	Low
256	RTC controller	Actual temperature, status			2 bytes	C	R	-	T	-	temperature (°C)	Low
257	RTC controller	Base temperature setpoint, status			2 bytes	C	R	-	T	-	temperature (°C)	Low
258	RTC controller	Setpoint offset, status			2 bytes	C	R	-	T	-	temperature differenc...	Low
259	RTC controller	Current temperature setpoint, status			2 bytes	C	R	-	T	-	temperature (°C)	Low
260	RTC controller	Heating/Cooling mode, status			1 bit	C	R	-	T	-	cooling/heating	Low
261	RTC controller	Operation mode, status			1 byte	C	R	-	T	-	HVAC mode	Low
262	RTC controller	Comfort mode, status			1 bit	C	R	-	T	-	enable	Low
263	RTC controller	Economy mode, status			1 bit	C	R	-	T	-	enable	Low
264	RTC controller	Frost/Heat protection mode, status			1 bit	C	R	-	T	-	enable	Low
265	RTC controller	Standby mode, status			1 bit	C	R	-	T	-	enable	Low
266	RTC controller	Heating control value			1 byte	C	R	-	T	-	percentage (0..100%)	Low
267	RTC controller	Cooling control value			1 bit	C	R	-	T	-	switch	Low
268	RTC controller	Fan speed			1 byte	C	-	-	T	-	percentage (0..100%)	Low
269	RTC controller	Fan speed low			1 bit	C	-	-	T	-	switch	Low
270	RTC controller	Fan speed medium			1 bit	C	-	-	T	-	switch	Low
271	RTC controller	Fan speed high			1 bit	C	-	-	T	-	switch	Low
272	RTC controller	Fan speed off			1 bit	C	-	-	T	-	switch	Low
273	RTC controller	Additional heating control value			1 bit	C	R	-	T	-	switch	Low
274	RTC controller	Additional cooling control value			1 bit	C	R	-	T	-	switch	Low

Fig.6.6 “RTC function” communication object

NO.	Object Function	Name	Data Type	Flag	DPT
240	Power on/off	RTC controller	1bit	C,W,R	1.001 switch
<p>The communication object is used to receive the telegram from the bus to control RTC power on/off. Telegrams:</p> <p style="padding-left: 40px;">1—On</p> <p style="padding-left: 40px;">0—Off</p>					
241	External temperature sensor	RTC controller	2byte	C,W,T,U	9.001 temperature
<p>The communication object is used to receive the temperature value detected by the temperature sensor of the device form the bus. Range:-50~99.8°C</p>					
242	Current setpoint adjustment Base setpoint adjustment	RTC controller	2byte	C,W	9.001 temperature
<p>“Current setpoint adjustment” is visible when operation mode is not enabled, and under absolute adjustment. Used to modify the base value of the set temperature; and to modify set temperature value of current room operation mode when absolute adjustment.</p>					

<p>“Base setpoint adjustment” is visible only when relative adjustment, used to modify the base value of the set temperature, that is, the temperature setting value of the comfort mode, and the setting temperature of the standby mode and the economy mode changes according to the relative change. In the protection mode, only the temperature setting value of the protection mode is modified.</p>					
243	Setpoint offset	RTC controller	1bit	C,W	1.007 step
<p>The communication object is visible only when absolute adjustment, and offset function enabled. Used to adjust the offset to adjust setpoint temperature indirectly. The step value set according to the parameter. Telegrams:</p> <p style="padding-left: 40px;">1 —Increase the offset in the forward direction</p> <p style="padding-left: 40px;">0 —Decrease the offset in the negative direction</p>					
244	Float offset value	RTC controller	2byte	C,W	9.002 temperature difference
<p>The communication object is visible only when absolute adjustment, and offset function enabled. Used to modify the accumulated offset via 2 byte float value.</p>					
245	Setpoint offset reset	RTC controller	1bit	C,W	1.015 reset
<p>The communication object is visible only when absolute adjustment, and offset function enabled. Reset offset value when telegram is 1.</p>					
246	Heating/Cooling mode	RTC controller	1bit	C,W	1.100 cooling/heating
<p>The communication object is used for switching the heating and cooling via the bus. Telegrams:</p> <p style="padding-left: 40px;">1 —Heating</p> <p style="padding-left: 40px;">0 —Cooling</p>					
247	Operation mode	RTC controller	1byte	C,W	20.102 HVAC mode
248	Comfort mode	RTC controller	1bit	C,W	1.003 enable
249	Economy mode	RTC controller	1bit	C,W	1.003 enable
250	Frost/Heat protection mode	RTC controller	1bit	C,W	1.003 enable
251	Standby mode	RTC controller	1bit	C,W	1.003 enable
<p>These communication objects are used to control the RTC operation mode via the bus.</p> <p>When 1 byte: object 247 is visible, telegrams: 1-comfort, 2-standby, 3-economy, 4-protection, other reserved.</p> <p>When 1bit:</p> <p style="padding-left: 40px;">Object 248— Comfort mode</p> <p style="padding-left: 40px;">Object 249— Standby mode</p> <p style="padding-left: 40px;">Object 250— Economy mode</p> <p style="padding-left: 40px;">Object 251— Protection mode</p>					

<p>When the object receives the telegram “1”, the corresponding mode is activated. When 1 bit standby object is not enable, and the telegrams of comfort, economy, protection mode are 0, is standby mode. When 1 bit standby object is enable, standby object receives “1” activates standby mode, 0 is no processing.</p>					
252	Extended comfort mode	RTC controller	1bit	C,W	1.016 acknowledge
<p>The communication object is used for triggering time to extended comfort mode. Telegrams:</p> <p>1—Activate comfort mode</p> <p>0—No sense</p> <p>Activate comfort mode when the object receives telegram 1. If receive again telegram 1 in delay time, time will be timed again. And return the previous operation mode from comfort mode once finish timing. If there is a new operation mode in delay time, exit the comfort mode.</p> <p>If a switch operation, exit the timing, but switch the heating/cooling will not.</p>					
253	Fan automatic operation	RTC controller	1bit	C,W	1.003 enable
<p>The communication object is used to activate the fan automatic operation via the bus. Telegram:</p> <p>1—Auto</p> <p>0—Exit auto</p>					
254	Window contact	RTC controller	1bit	C,W,U	1.019 Window/door
<p>The communication object is used to receive the switch status of window contact. Telegrams:</p> <p>1—Open window</p> <p>0—Close window</p>					
255	External presence detector	RTC controller	1bit	C,W,U	1.018 occupancy
<p>This object is visible when use external presence sensor to detect input. Used to receive presence status of external sensor. Options:</p> <p>1—Some one</p> <p>0—No one</p>					
256	Actual temperature, status	RTC controller	2byte	C,R,T	9.001 temperature
<p>The communication object is visible when temperature reference of RTC function is combination of internal and external sensor. Used to send the actual temperature after the combination to the bus.</p>					
257	Base temperature setpoint, status	RTC controller	2byte	C,R,T	9.001 temperature
<p>The communication object is visible only when relative adjustment. Used to send the current base set temperature to the bus.</p> <p>Current base set temperature value = parameter set value (or object 150 base value)+accumulated offset value</p>					
258	Setpoint offset, status	RTC controller	2byte	C,R,T	9.002 temperature difference

The communication object is visible only when relative adjustment. Used to send the accumulated offset value of base set temperature to the bus.					
259	Current temperature setpoint, status	RTC controller	2byte	C,R,T	9.001 temperature
The communication object is used to send current set temperature to the bus.					
260	Heating/Cooling mode, status	RTC controller	1bit	C,R,T	1.100 cooling/heating
The communication object is used to feedback the telegram of switching cooling and heating function to the bus.					
261	Operation mode, status	RTC controller	1byte	C,R,T	20.102 HVAC mode
262	Comfort mode, status	RTC controller	1bit	C,R,T	1.003 enable
263	Economy mode, status	RTC controller	1bit	C,R,T	1.003 enable
264	Frost/Heat protection mode, status	RTC controller	1bit	C,R,T	1.003 enable
265	Standby mode, status	RTC controller	1bit	C,R,T	1.003 enable
<p>These communication objects are used to send RTC operation mode status to the bus.</p> <p>When 1 byte: object 261 is visible, telegrams: 1-comfort, 2-standby, 3-economy, 4-protection, other reserved.</p> <p>When 1 bit:</p> <ul style="list-style-type: none"> Object 262— Comfort mode Object 263— Economy mode Object 264— Protection mode Object 265— Standby mode <p>When a mode is activated, the corresponding object only sends telegram "1". When 1 bit standby object is not enable, activate standby mode when comfort, economy, protection objects send telegram 0 together. When 1 bit standby object is enable, activate standby mode only when standby object send 1.</p> <p>Note: no requirement to send mode status to the bus when switchover via bus. The same is fan speed and other operation.</p>					
266	Heating control value Heating/Cooling control value	RTC controller	1bit 1byte	C,R,T	1.001 Switch 5.001 percentage
267	Cooling control value	RTC controller	1bit 1byte	C,R,T	1.001 Switch 5.001 percentage
These communication objects are used to send control value of heating or cooling function to the bus. Object datatype is according to parameter setting.					
268	Fan speed	RTC controller	1byte	C,T	5.001 percentage 5.100 fan stage
269	Fan speed low	RTC controller	1bit	C,T	1.001 switch
270	Fan speed medium	RTC controller	1bit	C,T	1.001 switch
271	Fan speed high	RTC controller	1bit	C,T	1.001 switch

272	Fan speed off	RTC controller	1bit	C,T	1.001 switch
<p>These communication objects are used to send control telegrams of the fan speed to the bus.</p> <p>1bit object is visible according to the parameter setting :</p> <p>Object 269—Low fan speed</p> <p>Object 270—Medium fan speed</p> <p>Object 271—High fan speed</p> <p>Object 272—Fan speed off</p> <p>Only the corresponding object sends telegram “1” when switch to a certain fan speed. When 1bit-off object is not enable, all objects send telegrams “0” when switch to fan speed off (The situation apply to connect with fan actuator of GVS);</p> <p>When 1bit-off object is enable, only 1bit-off object send telegram “1” (The situation apply to connect with fan actuator of other manufacturers).</p> <p>1byte: the corresponding telegram value of each fan speed is defined by the parameter. Activate the corresponding fan speed on the screen, and object 176 sends the corresponding telegram value of the fan speed to the bus.</p>					
273	Additional heating control value Additional heating/cooling control value	RTC controller	1bit 1byte	C,R,T	1.001 switch 5.001 percentage
274	Additional cooling control value	RTC controller	1bit 1byte	C,R,T	1.001 switch 5.001 percentage
<p>These communication objects are used to send additional control value of heating or cooling function to the bus. Object datatype is according to parameter setting.</p> <p>If 1bit is selected, when open valve, send telegram 1 to the bus, while close valve, send telegram 0;</p> <p>If 1byte is selected, when open valve, send 100% to the bus, while close valve, send 0%.</p>					

Table 6.6 “RTC function” communication object table

6.7. “Logic function” Communication Object

6.7.1. “AND/OR/XOR” Communication Object

Numbe	Name	Object Function	Descript	Group Ad	Length	C	R	W	T	U	Data Type	Priority
11	1st Logic	Input a			1 bit	C	-	W	T	U	boolean	Low
12	1st Logic	Input b			1 bit	C	-	W	T	U	boolean	Low
13	1st Logic	Input c			1 bit	C	-	W	T	U	boolean	Low
14	1st Logic	Input d			1 bit	C	-	W	T	U	boolean	Low
15	1st Logic	Input e			1 bit	C	-	W	T	U	boolean	Low
16	1st Logic	Input f			1 bit	C	-	W	T	U	boolean	Low
17	1st Logic	Input g			1 bit	C	-	W	T	U	boolean	Low
18	1st Logic	Input h			1 bit	C	-	W	T	U	boolean	Low
19	1st Logic	Logic result			1 bit	C	-	-	T	-	boolean	Low

Fig.6.7.1 “AND/OR/XOR” communication object

NO.	Object Function	Name	Data Type	Flag	DPT
11/.../18	Input x	{{1st Logic}}	1bit	C,W,T,U	1.002 boolean
The communication object is used to receive the value of logical input Input x. The name in parentheses changes with the parameter “Description for logic function”. If description is empty, display “1st Logic” by default. The same below.					
19	Logic result	{{1st Logic}}	1bit	C,T	1.002 boolean
The communication object is used to send the results of logical operation.					

Table 6.7.1 “AND/OR/XOR” communication object table

6.7.2. “Gate forwarding” Communication Object

Numbe	Name	Object Function	Descript	Group Ad	Length	C	R	W	T	U	Data Type	Priority
11	1st Logic	Gate value select			1 byte	C	-	W	-	-	scene number	Low
12	1st Logic	Input A			1 bit	C	-	W	-	-	switch	Low
13	1st Logic	Input B			1 bit	C	-	W	-	-	switch	Low
14	1st Logic	Input C			1 bit	C	-	W	-	-	switch	Low
15	1st Logic	Input D			1 bit	C	-	W	-	-	switch	Low
16	1st Logic	Output A			1 bit	C	-	-	T	-	switch	Low
17	1st Logic	Output B			1 bit	C	-	-	T	-	switch	Low
18	1st Logic	Output C			1 bit	C	-	-	T	-	switch	Low
19	1st Logic	Output D			1 bit	C	-	-	T	-	switch	Low

Fig.6.7.2 “Gate forwarding” communication object

NO.	Object Function	Name	Data Type	Flag	DPT
11	Gate value select	{{1st Logic}}	1byte	C,W	17.001 scene number
The communication object is used to select the scene of logical gate forwarding.					
12/.../15	Input x	{{1st Logic}}	1bit 4bit 1byte	C,W	1.001 switch 3.007 dimming control 5.010 counter pulses(0..255)
The communication object is used to receive the value of the logic gate input Input x.					

16/..19	Output x	{{1st Logic}}	1bit 4bit 1byte	C,T	1.001 switch 3.007 dimming control 5.010 counter pulses(0..255)
<p>The communication object is used to output the value forwarded by the logic gate. The output value is the same as the input value, but one input can be forwarded into one or more outputs, set by parameters.</p>					

Table 6.7.2 "Gate forwarding" communication object table

6.7.3. "Threshold comparator" Communication Object

Number	Name	Object Function	Description	Group Address	Length	C	R	W	T	U	Data Type	Priority
11	1st Logic	Threshold value input			4 bit	C	-	W	-	U	dimming control	Low
11	1st Logic	Threshold value input			1 byte	C	-	W	-	U	counter pulses (0..255)	Low
11	1st Logic	Threshold value input			2 bytes	C	-	W	-	U	pulses	Low
11	1st Logic	Threshold value input			2 bytes	C	-	W	-	U	2-byte signed value	Low
11	1st Logic	Threshold value input			2 bytes	C	-	W	-	U	2-byte float value	Low
11	1st Logic	Threshold value input			4 bytes	C	-	W	-	U	counter pulses (unsigned)	Low
11	1st Logic	Threshold value input			2 bytes	C	-	W	-	U	temperature (°C)	Low
11	1st Logic	Threshold value input			2 bytes	C	-	W	-	U	humidity (%)	Low
11	1st Logic	Threshold value input			2 bytes	C	-	W	-	U	lux (Lux)	Low
19	1st Logic	Logic result			1 bit	C	-	-	T	-	boolean	Low

Fig.6.7.3 "Threshold comparator" communication object

NO.	Object Function	Name	Data Type	Flag	DPT
11	Threshold value input	{{1st Logic}}	4bit 1byte 2byte 4byte	C,W, U	3.007 dimming 5.010 counter pulses 7.001 pulses 12.001 counter pulses 8.x signed value 9.x float value 9.001 temperature 9.007 humidity 9.004 lux
<p>The communication object is used to input threshold value.</p>					
19	Logic result	{{1st Logic}}	1bit	C,T	1.002 boolean
<p>The communication object is used to send the results of logical operation. That is, the value that should be sent after the object input threshold is compared with the setting threshold value.</p>					

Table 6.7.3 "Threshold comparator" communication object table

6.7.4. "Format convert" Communication Object

Numbe	Name	Object Function	Descript	Group Ad	Length	C	R	W	T	U	Data Type	Priority
11	1st Logic	Input 1bit-bit0			1 bit	C	-	W	-	U	boolean	Low
12	1st Logic	Input 1bit-bit1			1 bit	C	-	W	-	U	boolean	Low
19	1st Logic	Output 2bit			2 bit	C	-	-	T	-	switch control	Low

"2x1bit -> 1x2bit"function: converts two 1bit values to a 2bit value, such as Input bit1=1, bit0=0-->

Output 2bit=2

Numbe	Name	Object Function	Descript	Group Ad	Length	C	R	W	T	U	Data Type	Priority
11	1st Logic	Input 1bit-bit0			1 bit	C	-	W	-	U	boolean	Low
12	1st Logic	Input 1bit-bit1			1 bit	C	-	W	-	U	boolean	Low
13	1st Logic	Input 1bit-bit2			1 bit	C	-	W	-	U	boolean	Low
14	1st Logic	Input 1bit-bit3			1 bit	C	-	W	-	U	boolean	Low
15	1st Logic	Input 1bit-bit4			1 bit	C	-	W	-	U	boolean	Low
16	1st Logic	Input 1bit-bit5			1 bit	C	-	W	-	U	boolean	Low
17	1st Logic	Input 1bit-bit6			1 bit	C	-	W	-	U	boolean	Low
18	1st Logic	Input 1bit-bit7			1 bit	C	-	W	-	U	boolean	Low
19	1st Logic	Output 1byte			1 byte	C	-	-	T	-	counter pulses (0..255)	Low

"8x1bit -> 1x1byte"function: converts eight 1bit values to a 1byte value, such as Input bit2=1, bit1=1,

bit0=1,other bits are 0--> Output 1byte=7

Numbe	Name	Object Function	Descript	Group Ad	Length	C	R	W	T	U	Data Type	Priority
11	1st Logic	Input 1byte			1 byte	C	-	W	-	U	counter pulses (0..255)	Low
19	1st Logic	Output 2byte			2 bytes	C	-	-	T	-	pulses	Low

"1x1byte -> 1x2byte"function: converts one 1byte values to a 2byte value, such as Input 1byte=125-->

Output 2byte=125.Although the value remains the same, the data type of the value is different.

Numbe	Name	Object Function	Descript	Group Ad	Length	C	R	W	T	U	Data Type	Priority
11	1st Logic	Input 1byte-low			1 byte	C	-	W	-	U	counter pulses (0..255)	Low
12	1st Logic	Input 1byte-high			1 byte	C	-	W	-	U	counter pulses (0..255)	Low
19	1st Logic	Output 2byte			2 bytes	C	-	-	T	-	pulses	Low

"2x1byte -> 1x2byte"function: converts two 1byte values to a 2byte value, such as Input 1byte-low

= 255 (\$FF), Input 1byte-high = 100 (\$64) --> Output 2byte = 25855 (\$64 FF)

Numbe	Name	Object Function	Descript	Group Ad	Length	C	R	W	T	U	Data Type	Priority
11	1st Logic	Input 2byte-low			2 bytes	C	-	W	-	U	pulses	Low
12	1st Logic	Input 2byte-high			2 bytes	C	-	W	-	U	pulses	Low
19	1st Logic	Output 4byte			4 bytes	C	-	-	T	-	counter pulses (unsigned)	Low

"2x2byte -> 1x4byte"function: converts two 2 byte values to a 4byte value, such as Input 2byte-low =

65530 (\$FF FA), Input 2byte-high = 32768 (\$80 00)--> Output 2byte = 2147549178 (\$80 00 FF FA)

Numbe	Name	Object Function	Descript	Group Ad	Length	C	R	W	T	U	Data Type	Priority
11	1st Logic	Input 1byte			1 byte	C	-	W	-	U	counter pulses (0..255)	Low
12	1st Logic	Output 1bit-bit0			1 bit	C	-	-	T	-	boolean	Low
13	1st Logic	Output 1bit-bit1			1 bit	C	-	-	T	-	boolean	Low
14	1st Logic	Output 1bit-bit2			1 bit	C	-	-	T	-	boolean	Low
15	1st Logic	Output 1bit-bit3			1 bit	C	-	-	T	-	boolean	Low
16	1st Logic	Output 1bit-bit4			1 bit	C	-	-	T	-	boolean	Low
17	1st Logic	Output 1bit-bit5			1 bit	C	-	-	T	-	boolean	Low
18	1st Logic	Output 1bit-bit6			1 bit	C	-	-	T	-	boolean	Low
19	1st Logic	Output 1bit-bit7			1 bit	C	-	-	T	-	boolean	Low

“1x1byte --> 8x1bit” function: converts one 1byte values to eight 1bit value, such as Input 1byte=200 --> Output bit0=0, bit1=0, bit2=0, bit3=1, bit4=0, bit5=0, bit6=1, bit7=1

Numbe	Name	Object Function	Descript	Group Ad	Length	C	R	W	T	U	Data Type	Priority
11	1st Logic	Input 2byte			2 bytes	C	-	W	-	U	pulses	Low
18	1st Logic	Output 1byte-low			1 byte	C	-	-	T	-	counter pulses (0..255)	Low
19	1st Logic	Output 1byte-high			1 byte	C	-	-	T	-	counter pulses (0..255)	Low

“1x2byte --> 2x1byte”function: converts one 2byte values to two 1byte value, such as Input 2byte = 55500 (\$D8 CC) --> Output 1byte-low = 204 (\$CC), Output 1byte-high =216 (\$D8)

Numbe	Name	Object Function	Descript	Group Ad	Length	C	R	W	T	U	Data Type	Priority
11	1st Logic	Input 4byte			4 bytes	C	-	W	-	U	counter pulses (unsigned)	Low
18	1st Logic	Output 2byte-low			2 bytes	C	-	-	T	-	pulses	Low
19	1st Logic	Output 2byte-high			2 bytes	C	-	-	T	-	pulses	Low

“1x4byte --> 2x2byte”function: converts one 4byte values to two 2byte value, such as Input 4byte = 78009500 (\$04 A6 54 9C) --> Output 2byte-low = 21660 (\$54 9C), Output 2byte-high =1190 (\$04 A6)

Numbe	Name	Object Function	Descript	Group Ad	Length	C	R	W	T	U	Data Type	Priority
11	1st Logic	Input 3byte			3 bytes	C	-	W	-	U	RGB value 3x(0..255)	Low
17	1st Logic	Output 1byte-low			1 byte	C	-	-	T	-	counter pulses (0..255)	Low
18	1st Logic	Output 1byte-middle			1 byte	C	-	-	T	-	counter pulses (0..255)	Low
19	1st Logic	Output 1byte-high			1 byte	C	-	-	T	-	counter pulses (0..255)	Low

“1x3byte --> 3x1byte”function: converts one 3byte values to three 1byte value, such as Input 3byte = \$78 64 C8--> Output 1byte-low = 200 (\$C8) , Output 1byte-middle = 100 (\$64) , Output 1byte-high =120 (\$78)

Numbe	Name	Object Function	Descript	Group Ad	Length	C	R	W	T	U	Data Type	Priority
11	1st Logic	Input 1byte-low			1 byte	C	-	W	-	U	counter pulses (0..255)	Low
12	1st Logic	Input 1byte-middle			1 byte	C	-	W	-	U	counter pulses (0..255)	Low
13	1st Logic	Input 1byte-high			1 byte	C	-	W	-	U	counter pulses (0..255)	Low
19	1st Logic	Output 3byte			3 bytes	C	-	-	T	-	RGB value 3x(0..255)	Low

“3x1byte --> 1x3byte”function: converts three 1byte values to a 3byte value, such as Input 1byte-low = 150 (\$96), Input 1byte-middle = 100 (\$64), Input 1byte-high = 50 (\$32)--> Output 3byte = \$32 64 96

Fig.6.7.4 “Format convert” communication object

NO.	Object Function	Name	Data Type	Flag	DPT
11	Input ...	{{1st Logic}}	1bit 1byte 2byte 3byte 4byte	C,W,U	1.001 switch 5.010 counter pulses(0..255) 7.001 pulses 232.600 RGB value 3x(0..255) 12.001 counter pulses
The communication object is used to input a value that needs to be converted.					
19	Output ...	{{1st Logic}}	1bit 2bit 1byte 2byte 3byte 4byte	C,T	1.001 switch 2.001 switch control 5.010 counter pulses(0..255) 7.001 pulses 232.600 RGB value 3x(0..255) 12.001 counter pulses
The communication object is used to output the converted value.					

Table 6.7.4 "Format convert" communication object table

6.7.5. "Gate function" Communication Object

Numbe	Name	Object Function	Descript	Group Ad	Length	C	R	W	T	U	Data Type	Priority
11	1st Logic	Input			1 bit	C	-	W	-	-	switch	Low
12	1st Logic	Gate input			1 bit	C	-	W	-	-	boolean	Low
19	1st Logic	Output			1 bit	C	-	-	T	-	switch	Low
Input/Output - 1bit[On/Off]												
Numbe	Name	Object Function	Descript	Group Ad	Length	C	R	W	T	U	Data Type	Priority
11	1st Logic	Input			1 byte	C	-	W	-	-	percentage (0..100%)	Low
12	1st Logic	Gate input			1 bit	C	-	W	-	-	boolean	Low
19	1st Logic	Output			1 byte	C	-	-	T	-	percentage (0..100%)	Low
Input/Output - 1byte[0..100%]												
Numbe	Name	Object Function	Descript	Group Ad	Length	C	R	W	T	U	Data Type	Priority
11	1st Logic	Input			1 byte	C	-	W	-	-	counter pulses (0..255)	Low
12	1st Logic	Gate input			1 bit	C	-	W	-	-	boolean	Low
19	1st Logic	Output			1 byte	C	-	-	T	-	counter pulses (0..255)	Low
Input/Output - 1byte[0..255]												
Numbe	Name	Object Function	Descript	Group Ad	Length	C	R	W	T	U	Data Type	Priority
11	1st Logic	Input			2 bytes	C	-	W	-	-	temperature (°C)	Low
12	1st Logic	Gate input			1 bit	C	-	W	-	-	boolean	Low
19	1st Logic	Output			2 bytes	C	-	-	T	-	temperature (°C)	Low
Input/Output - 2byte[Float]												
Numbe	Name	Object Function	Descript	Group Ad	Length	C	R	W	T	U	Data Type	Priority
11	1st Logic	Input			2 bytes	C	-	W	-	-	pulses	Low
12	1st Logic	Gate input			1 bit	C	-	W	-	-	boolean	Low
19	1st Logic	Output			2 bytes	C	-	-	T	-	pulses	Low
Input/Output - 2byte[0..65535]												

Fig.6.7.5 "Gate function" communication object

NO.	Object Function	Name	Data Type	Flag	DPT
11	Input	{{1st Logic}}	1bit 1byte 2byte	C,W	1.001 switch 5.001 percentage 5.010 counter pulses 9.001 temperature 7.001 pulses

The communication object is used to input a value that needs to gate filter.					
12	Gate input	{{1st Logic}}	1bit	C,W	1.002 boolean
The communication object is used to control the switch status of gate input. Input signal is allowed to pass when gate open, then output, and the current input status is still sent if there is a change; Can not pass when gate close.					
13	Output	{{1st Logic}}	bit 1byte 2byte	C,T	1.001 switch 5.001 percentage 5.010 counter pulses 9.001 temperature 7.001 pulses
The communication object is used to output the value after gate filtering. Only when gate input status is open, output is available, defined by the object "Gate input".					

Table 6.7.5 "Gate function" communication object table

6.7.6. "Delay function" Communication Object

Numbe	Name	Object Function	Descript	Group Ad	Length	C	R	W	T	U	Data Type	Priority
11	1st Logic	Input			1 bit	C	-	W	-	-	switch	Low
19	1st Logic	Output			1 bit	C	-	-	T	-	switch	Low
Input/Output - 1bit[On/Off]												
Numbe	Name	Object Function	Descript	Group Ad	Length	C	R	W	T	U	Data Type	Priority
11	1st Logic	Input			1 byte	C	-	W	-	-	percentage (0..100%)	Low
19	1st Logic	Output			1 byte	C	-	-	T	-	percentage (0..100%)	Low
Input/Output - 1byte[0..100%]												
Numbe	Name	Object Function	Descript	Group Ad	Length	C	R	W	T	U	Data Type	Priority
11	1st Logic	Input			1 byte	C	-	W	-	-	counter pulses (0..255)	Low
19	1st Logic	Output			1 byte	C	-	-	T	-	counter pulses (0..255)	Low
Input/Output - 1byte[0..255]												
Numbe	Name	Object Function	Descript	Group Ad	Length	C	R	W	T	U	Data Type	Priority
11	1st Logic	Input			2 bytes	C	-	W	-	-	temperature (°C)	Low
19	1st Logic	Output			2 bytes	C	-	-	T	-	temperature (°C)	Low
Input/Output - 2byte[Float]												
Numbe	Name	Object Function	Descript	Group Ad	Length	C	R	W	T	U	Data Type	Priority
11	1st Logic	Input			2 bytes	C	-	W	-	-	pulses	Low
19	1st Logic	Output			2 bytes	C	-	-	T	-	pulses	Low
Input/Output - 2byte[0..65535]												

Fig.6.7.6 "Delay function" communication object

NO.	Object Function	Name	Data Type	Flag	DPT
11	Input	{{1st Logic}}	1bit 1byte 2byte	C,W	1.001 switch 5.001 percentage 5.010 counter pulses 9.001 temperature 7.001 pulses
The communication object is used to input a value that needs to delay.					

19	Output	{{1st Logic}}	1bit 1byte 2byte	C,T	1.001 switch 5.001 percentage 5.010 counter pulses 9.001 temperature 7.001 pulses
The communication object is used to output that needs to delay converted value, delay time is defined by the parameter.					

Table 6.7.6 "Delay function" communication object table

6.7.7. "Staircase lighting" Communication Object

Number	Name	Object Function	Description	Group Address	Length	C	R	W	T	U	Data Type	Priority
11	1st Logic	Trigger value			1 bit	C	-	W	-	-	trigger	Low
12	1st Logic	Light-on duration time			2 bytes	C	-	W	-	-	time (s)	Low
19	1st Logic	Output			1 bit	C	-	-	T	-	switch	Low
19	1st Logic	Output			1 byte	C	-	-	T	-	counter pulses (0..255)	Low

Fig.6.7.7 "Staircase lighting" communication object

NO.	Object Function	Name	Data Type	Flag	DPT
11	Trigger value	{{1st Logic}}	1bit	C,W	1.017 trigger
The communication object is used to receive the value to trigger staircase lighting.					
12	Light-on duration time	{{1st Logic}}	2byte	C,W	7.005 time(s)
The communication object is used to modify the staircase light-on duration time, the modified range is referenced from the range defined by the parameter, take the limit value if exceeded.					
19	Output	{{1st Logic}}	1bit 1byte	C,T	1.001 switch 5.010 counter pulses
The communication object is used to output value 1 when trigger, and send value 2 after duration time. Telegram value is determined by the parameter setting datatype.					

Table 6.7.7 "Staircase lighting" communication object table

6.8. “Scene Group” Communication Object

Number	Name	Object Function	Description	Group Address	Length	C	R	W	T	U	Data Type	Priority
83	Scene Group	Main scene trigger			1 byte	C	-	W	-	-	scene number	Low
84	1st Scene Group-Output 1	1bit value			1 bit	C	-	-	T	-	switch	Low
85	1st Scene Group-Output 2	1bit value			1 bit	C	-	-	T	-	switch	Low
86	1st Scene Group-Output 3	1bit value			1 bit	C	-	-	T	-	switch	Low
87	1st Scene Group-Output 4	1bit value			1 bit	C	-	-	T	-	switch	Low
88	1st Scene Group-Output 5	1bit value			1 bit	C	-	-	T	-	switch	Low
89	1st Scene Group-Output 6	1bit value			1 bit	C	-	-	T	-	switch	Low
90	1st Scene Group-Output 7	1bit value			1 bit	C	-	-	T	-	switch	Low
91	1st Scene Group-Output 8	1bit value			1 bit	C	-	-	T	-	switch	Low

Fig.6.8 “Scene Group” communication object

NO.	Object Function	Name	Data Type	Flag	DPT
83	Main scene trigger	Scene Group	1byte	C,W	17.001 scene number
<p>This communication object triggers each output in the scene group to send a specific value to the bus by recalling the scene number. Telegrams: 0.. 63</p>					
84/..	1bit value 1byte unsigned value HVAC mode 2byte unsigned value Temperature	1st Scene Group-{{Output x}}	1bit 1byte 2byte	C,T	1.001 switch 5.010 counter pulses 20.102 HVAC mode 7.001 pulses 9.001 temperature
<p>When a scene is recalled, the communication object is used to send the corresponding output value of the scene to the bus. If the output is not set to this scene, it will not be sent.</p> <p>A total of 8 scene groups can be set up, with 8 outputs per group.</p> <p>The name in parentheses changes with the parameter “Description for Output x function”. If description is empty, display “1st Scene Group-Output x” by default. The same below.</p>					

Table 6.8 “Scene Group” communication object table