

K-BUS[®] Dimming Actuators

User manual-Ver. 2

KA/D 0103.1

KA/D 0203.1

KA/D 0403.1

KA/D 04.T1.1

ADTV-04/16.1

KA/D 04.L1.1

ADLD-04/03.1

KNX/EIB Intelligent Installation Systems



Content

1. Introduction	3
1.1 Universal Dimming Actuator	4
1.2 Dimming Controller, 4fold, 0~10V	5
1.3 Dimming Controller, 4fold, 0/1~10V	6
1.4 LED Dimming Actuator, 4fold, 350mA	7
1.5 LED Dimming Actuator, 4fold, 4A	8
2. Technical characteristic	9
2.1 Universal Dimming Actuator KA/D xx03.1	9
2.1.1 Technical data	9
2.1.2 Load type	10
2.1.3 Dimming operation mode	11
2.2 Dimming controller, 4fold, 0~10V KA/D 04.T1.1	11
2.2.1 Technical data	11
2.3 Dimming controller, 4fold, 0/1~10V ADTV-04/16.1	12
2.3.1 Technical data	12
2.4 LED Dimming Actuator, 4fold, 350mA KA/D 04.L1.1	13
2.4.1 Technical data	13
2.5 LED Dimming Actuator, 4fold, 4A ADLD-04/03.1	14
2.5.1 Technical data	14
3. Dimension and Connection Diagram	14
3.1 Universal Dimming Actuator	14
3.1.1 KA/D 0103.1	14
3.1.2 KA/D 0203.1	15
3.1.3 KA/D 0403.1	16
3.2 Dimming controller, 4fold, 0~10V	17
3.2.1 KA/D 04.T1.1	17
3.3 Dimming controller, 4fold, 0/1~10V	19
3.3.1 ADTV-04/16.1	19
3.4 LED Dimming Actuator, 4fold, 350mA	20
3.4.1 KA/D 04.L1.1	20
3.5 LED Dimming Actuator, 4fold, 4A	23
3.5.1 ADLD-04/03.1	23
4. Application Programming Introduction	24
4.1 Switch	24

4.2 Relative dimming	24
4.3 Absolute dimming	25
4.4 Status Report	25
4.5 Scene	25
4.6 Preset Value	25
4.7 Staircase Lighting Function	25
4.8 Reset	26
4.9 Error Report	26
4.10 Normal operation signs	27
5. Parameters Setup Description	27
5.1 Introduction	27
5.2 Parameter Window “Device general”	28
5.3 Parameter Window “CH X active”	30
5.4 Parameter Window “CHX general”	31
5.5 Parameter Window: dimming general	33
5.5.1 Setting of “CH X dimming general”	33
5.5.2 Parameter Window “X: dimming”	35
5.5.3 Parameter Window “X: scene page”	38
5.5.4 Parameter Window “X: preset”	40
5.6 Staircase Lighting Mode	41
6. Communication Object Description	43
6.1 Communication object of “Device General”	43
6.2 General communication object of “Dimming Actuator”	45
6.3 Scene function communication object of “Dimming Actuator”	46
6.4 Preset value function communication object “Dimming Actuator”	46
6.5 Staircase Lighting Function communication object of “Dimming Actuator”	47

1. Introduction

The dimming actuator (hereinafter referred to as dimmer) is a device dimming the luminaries directly by the data in the memory, and the data is processed in advance in the programming software according to the distribution characteristics of the luminaries’ brightness. The control circuit of dimmer transfers the brightness data value to output voltage or current to control the brightness of the luminaries.

The dimmers have universal dimmers, 1-10V DC dimmer, 0/1-10V DC dimmer, 350mA LED dimmer and 4A LED dimmer.

The universal dimmers carry out dimming via phase modulation, which have 3 categories: 1-channel,

2-channels and 4-channels. Max. Power of each channel is 500W for 1-channel and 2-channels dimmers and Max. Power of each channel is 400W for 4-channels dimmer. It is able to dim one independent group of luminary by 1-channel dimmer, 2 independent groups of luminaries by 2-channels dimmer, and 4 independent groups of luminaries by 4-channels dimmer.

0~10V DC dimming controller with standard DC 0-10V control interface, has 4 independent channels and one channel can control up to 23 electronic control gears (ECG), such as 23 ECG/18W, 14 ECG/36W, 11 ECG/58W or 23 ECG-T5/24W. The input need connect a 230V AC operating voltage for the device.

0/1~10V DC dimming controller with standard DC 0/1-10V control interface, has 4 independent channels and one channel can control up to 23 electronic control gears (ECG), such as 23 ECG/18W, 14 ECG/36W, 11 ECG/58W or 23 ECG-T5/24W. There is no additional voltage input.

The 350mA LED dimmer with LED constant current drive can drive LED directly, has four channels, each channel is independent and with two independent output. The output current of each channel can be set by linked switch current button and channel switch current button and can output 350mA/700mA or 700mA/1A.

The 4A LED dimmer with LED constant voltage drive can drive LED directly, has four channels, each channel is independent. The input need connect a 12-24V DC operating voltage for the device, the output voltage depends on the input voltage.

The Dimmer is a modular installation device for fixed installation in dry rooms. It fits on 35mm DIN rails in power distribution boards or closed compact boxes. It can be programmed; it can be use to customize the rooms' environment to build the various scenes, such as WATCH MOVIE, ENTERTAMENT, DINNER and REST and so on; it's brightness value can be set as any value (1-100%); it is able to set the duration time to dim up or down to the target brightness value and the gradual change speed to extend the luminaries life and save energy and so on.

It is able to use the Engineering Tool Software ETS (ETS2 version or more) with a VD2/VD3 file to allocate the physical address and set the parameters.

This manual describes a series of dimmers. Different dimmers apply to connect different type of lighting, but their functions are similar, *just in use you need to note the type of connected electrical load, thus reasonable select them and note their technical performance. If the technical performance of the selected load is not consistent with the technical performance of the dimmer, it is possible to cause damage to the dimmer or load.*

This manual provides the detailed technical information about various dimmers, not only the installation and programming details, but also the usage explanation in actual application.

1.1 Universal Dimming Actuator

The universal dimmers carry out dimming via phase modulation, have 1channel, 2channels and 4channels, each output of them is independent, which can connect with dimmable lamps, such as incandescent lamps, HV halogen lamps, LV halogen lamps(with conventional or suitable electronic transformers), dimmable energy saving

lamps and LED. These lamps can be switched, dimmed, recall scene or other operations via the bus.

The device has an integrated short-circuit and excess temperature protection.

The devices adopt screw terminals to achieve electrical connection; the connection to the EIB/KNX bus is established via a bus connecting terminal. The input need connect a 230V AC operation voltage. The following list provides a functional overview:

- ✧ Switching the light
- ✧ Relative dimming
- ✧ Absolute dimming
- ✧ Status report, error report
- ✧ Setting 15 scenes
- ✧ Staircase lighting function
- ✧ Bus recovery (or reset) function
- ✧ Preset value and modify preset value functions

The above function of parameters to configure and use are described in the chapter 5.

1.2 Dimming Controller, 4fold, 0~10V

0~10V DC control device with standard DC 0-10V control interface, can be connected with electronic dimmable ballast/EVG or other devices with 0-10V interface to control the lights, such as dimming, scenes, switching and so on.

The 0-10V DC control device has embedded switching relays for 23 ECG/18W, 14 ECG/36W, 11 ECG/58W or 23 ECG-T5/24W. Each channel offers control voltage up to 23 electronic control gears (ECG).

The devices adopt screw terminals to achieve electrical connection; the connection to the EIB/KNX bus is established via a bus connecting terminal. The input need connect a 230V AC operation voltage. The following list provides a functional overview:

- ✧ Switching the light
- ✧ Relative dimming
- ✧ Absolute dimming
- ✧ Status report
- ✧ Setting 15 scenes
- ✧ Staircase lighting function

- ✧ Preset value and modify preset value functions

The above function of parameters to configure and use are described in the chapter 5, the database file (.vd2) of the device is the same with KA/D 0403.1. But there is not the error report function for the device, and in the normal mode, there is not reset function after bus voltage recovery, i.e. the brightness status will not restore the last brightness value.

Note: Some lights cannot be turned off completely by dimming. In this case, you can turn off the lights via switching.

1.3 Dimming Controller, 4fold, 0/1~10V

0/1~10V DC control device with standard DC 0/1-10V control interface, can be connected with electronic dimmable ballast/EVG or other devices with 0/1-10V interface to control the lights, such as dimming, scenes, switching and so on.

The 0/1-10V DC control device has embedded switching relays for 23 ECG/18W, 14 ECG/36W, 11 ECG/58W or 23 ECG-T5/24W. Each channel offers control voltage up to 23 electronic control gears (ECG).

The devices adopt screw terminals to achieve electrical connection; the connection to the EIB/KNX bus is established via a bus connecting terminal. There is no additional voltage input. The following list provides a functional overview:

- ✧ Switching the light
- ✧ Relative dimming
- ✧ Absolute dimming
- ✧ Status report
- ✧ Setting 15 scenes
- ✧ Staircase lighting function
- ✧ Preset value and modify preset value functions
- ✧ Bus recovery (or reset) function
- ✧ Switch/relative dimming via manual buttons

The above function of parameters to configure and use are described in the chapter 5, the device has own database file (.vd4) (ADTV-04/16.1). And to set the output voltage type in the parameter according to the interface type of load, as 0-10V or 1-10V.

There is an electronic manual operation function in the normal dimming mode, but it is invalid in the staircase lighting mode. Switch via a short operation of the electronic manual buttons, relative dimming via a long

operation, and in the case of the bus voltage fail the manual operation is invalid. There is also mechanical manual operation function, and it can switch on or off the output at any time.

Note: Some lights cannot be turned off completely by dimming. In this case, you can turn off the lights via switching.

1.4 LED Dimming Actuator, 4fold, 350mA

The dimmer with LED constant current drive can drive LED directly, has four channels, each channel is independent and with two independent output. The output current of each channel can be set by linked switch current button and channel switch current button and can output 350mA/700mA or 700mA/1A. —*needs attention when the output current exceeds the rated current of the load, the load probably will burn out, for example, cannot use a 700mA output to drive 350mA LED. Meantime, in the case of full load, if all LEDs are 350mA, the dimmer can output 8 folds, but if some LEDs are 700mA or 1A, it cannot output 8 folds in some configuration, or the LED cannot reach expectant brightness value. The details are in section 3.3.*

When the output current is set manually, its value can be known via relevant indicators, the details in section 3.3.

The output can connect with some small power dimmable LED lights. These LEDs can be switched, dimmed, recall scene or other operations via the bus.

The devices adopt screw terminals to achieve electrical connection; the connection to the EIB/KNX bus is established via a bus connecting terminal. The input need connect a 12V~48V DC operation voltage. The following list provides a functional overview:

- ✧ Switching the LED light
- ✧ Relative dimming
- ✧ Absolute dimming
- ✧ Status report, error report
- ✧ Setting 15 scenes
- ✧ Staircase lighting function
- ✧ Bus recovery (or reset) function
- ✧ Preset value and modify preset value functions
- ✧ Set output current for per channel manually
- ✧ Switch/relative dimming via manual buttons

The above function of parameters to configure and use are described in the chapter 5. The database file (.vd2)

of the device is the same with KA/D 0403.1. But the error report function is different, the detail in section 4.9, 5.2. Meanwhile, there is added a manual operation function in the normal dimming mode, it is invalid in the staircase lighting mode. Switch via a short operation of manual buttons, relative dimming via a long operation, and in the case of the bus voltage fail the manual operation is invalid.

1.5 LED Dimming Actuator, 4fold, 4A

The dimmer with LED constant voltage drive can drive LED directly, has four channels, each channel is independent.

The output can connect with some big power dimmable LED lights. These LEDs can be switched, dimmed, recall scene or other operations via the bus.

The devices adopt screw terminals to achieve electrical connection; the connection to the EIB/KNX bus is established via a bus connecting terminal. The input need connect a 12V~24V DC operation voltage. The following list provides a functional overview:

- ✧ Switching the LED light
- ✧ Relative dimming
- ✧ Absolute dimming
- ✧ Status report, error report
- ✧ Setting 15 scenes
- ✧ Staircase lighting function
- ✧ Bus recovery (or reset) function
- ✧ Preset value and modify preset value functions
- ✧ Switch/relative dimming via manual buttons

The above function of parameters to configure and use are described in the chapter 5. The device has own database file (.vd4) (ADLD-04/03.1). There is added a manual operation function in the normal dimming mode, it is invalid in the staircase lighting mode. Switch via a short operation of manual buttons, relative dimming via a long operation, and in the case of the bus voltage fail the manual operation is invalid.

2. Technical characteristic

2.1 Universal Dimming Actuator KA/D xx03.1

2.1.1 Technical data

Power supply	Working voltage	21-30V DC, via EIB bus
	Input voltage	230 V AC (50/60Hz)
Output	KA/D 0103.1---1 channel	Max. output capacity 500W per channel
	KA/D 0203.1---2 channels	Max. output capacity 500W per channel
	KA/D 0403.1---4 channels	Max. output capacity 400W per channel
	Output voltage	230 V AC (50/60Hz), short-circuit and excess temperature protection
	Max. Leakage Loss	5W
Connections	EIB/KNX	EIB bus connection terminal
	Input, Load Circuits	Screw terminals
Operation and display	Button and red LED	For assigning physical address
	Green LED flashing	Indicate the device running normally
Type of protection	IP 20 , EN 60 529	
Temperature	Operation	-5 °C ... + 45 °C
	Storage	-25 °C ... + 55 °C
	Transport	-25 °C ... + 70 °C
Ambient	Humidity	<93%, except dewing
Mounting	On 35mm DIN rail	
Dimensions	KA/D 0103.1--- 90×71.5×60 mm	
	KA/D 0203.1--- 90×143×60 mm	
	KA/D 0403.1--- 90×214.5×60 mm	
CE norm	In accordance with the EMC guideline and the low voltage guideline	
Certification	EIB/KNX certified	

Weight	KA/D 0103.1--- 0.3kg
	KA/D 0203.1--- 0.5kg
	KA/D 0403.1--- 0.75kg

2.1.2 Load type

Resistive loads:

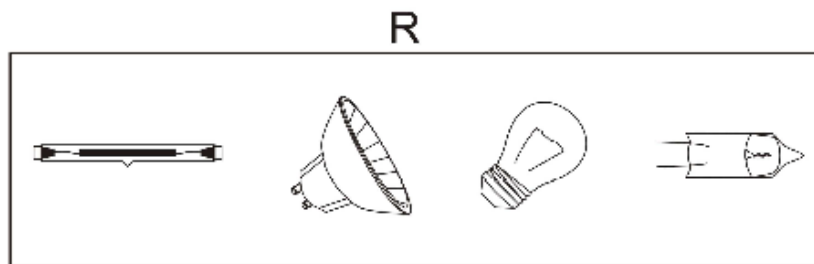

Capacitive loads:

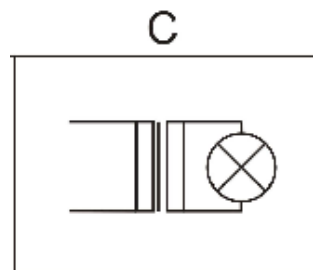

Inductive loads:

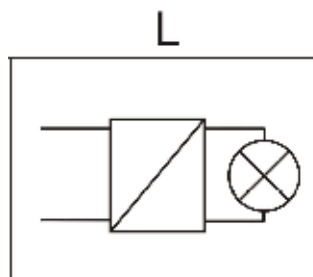

Note: *it is however not permitted to connect inductive, capacitive and resistive loads together at the same output, i.e. only permitted to connect same type loads for a output.*

2.1.3 Dimming operation mode

Dimmer operation is in leading or trailing edge.

Explanation of the dimming system: dimmer will be on at the zero-crossing point, seen below Figure. During this moment, the voltage is very low, and there is no current impact to the load, which is able to not only extend the lamp life, but also reduce disturb to the power grid.

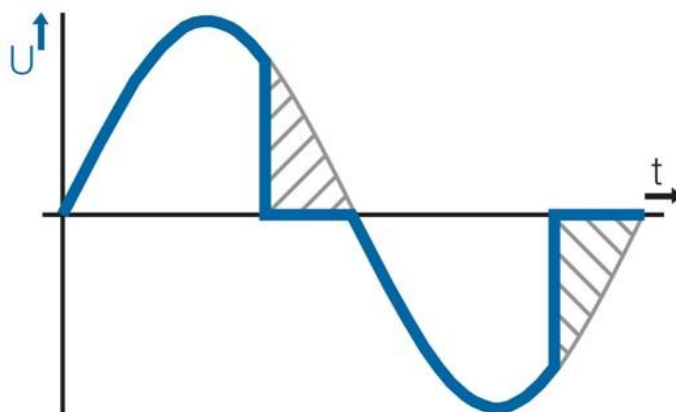

2.2 Dimming controller, 4fold, 0~10V KA/D 04.T1.1

2.2.1 Technical data

Power supply	Operating voltage	21-30V DC, via the EIB bus
	Input voltage	100~240V AC
Output	Number	4 channel switching/dimming
	Output voltage	0~10V DC, max.100mA
	Switch current	16A /250V AC, If fluorescent lamp, allowable Max. current is 4A
	Safety	Short-circuit protection
Connections	EIB/KNX	KNX/EIB bus connection terminal
	Inputs/outputs	Using screw terminals
Operation and display	Button and red LED	For assigning the physical address
	Green LED flashing	Indicate the application layer running normally
Temperature	Operation	-5 °C ... + 45 °C
	Storage	- 25 °C ... + 55 °C

	Transport	-25 °C ... + 70 °C
Ambient	Humidity	<93%, except dewing
Type of protection	IP 20 , EN 60 529	
Mounting	On 35mm DIN rail	
Dimension	90×143×60 mm	
Weight	0.5kg	

2.3 Dimming controller, 4fold, 0/1~10V ADTV-04/16.1

2.3.1 Technical data

Power supply	Operating voltage	21-30V DC, via the EIB bus
Output	Number	4 channel switching/dimming
	Output voltage	1~10V DC, max.100mA per channel
	Switch current	16A /250V AC, If fluorescent lamp, allowable Max. current is 10A/250V (140µF)
Connections	EIB/KNX	KNX/EIB bus connection terminal
	Outputs	Using screw terminals
Operation and display	Button and red LED	For assigning the physical address
	Green LED flashing	Indicate the application layer running normally
Temperature	Operation	-5 °C ... + 45 °C
	Storage	- 25 °C ... + 55 °C
	Transport	-25 °C ... + 70 °C
Ambient	Humidity	<93%, except dewing
Type of protection	IP 20 , EN 60 529	
Mounting	On 35mm DIN rail	
Dimension	90×143×60 mm	
Weight	0.4kg	

2.4 LED Dimming Actuator, 4fold, 350mA KA/D 04.L1.1

2.4.1 Technical data

Power supply	Operating voltage	21-30V DC, via the EIB bus
	Input	12-48V DC
Output	4 channels	Each channel with two outputs
	Current	Constant current 350mA/700mA
	Load voltage	3-48V DC
	Safety	Short-circuit and excess temperature protection
Connections	EIB/KNX	EIB bus connection terminal
	Inputs/outputs	Using screw terminals
Operation and display	Button and red LED	For assigning the physical address
	Green LED flashing	Indicate the application layer running normally
	LEDs for Output	Indicate output status per channel, LED on mean the channel has output, LED off mean the channel has not output.
	Manual buttons	Switch via a short operation, relative dimming via a long operation
	LED for a channel	The LED on mean output current of the channel has increased by 350mA, or else no increase
	Switch current button for a channel	Set output current for a channel, when switch on, output current of the channels is added 350mA, and its LED on; or else no add
	LEDs for all channels	The LED on mean output current of all channels have increased by 350mA, or else no increase
	Switch current button for all channels	Set output current for all channels, when switch on, output current of all channels is added 350mA, and its LED on; or else no add
Type of protection	IP 20 , EN 60 529	
Temperature	Operation	-5 °C ... + 45 °C
	Storage	- 25 °C ... + 55 °C
	Transport	- 25 °C ... + 70 °C
Ambient	Humidity	<93%, except dewing
Mounting	On 35mm DIN rail	
Dimension	90×72×64.2 mm	
Weight	0.3kg	

2.5 LED Dimming Actuator, 4fold, 4A ADLD-04/03.1

2.5.1 Technical data

Power supply	Operating voltage	21-30V DC, via the EIB bus
	Input	12-24V DC
Output	4 channels	
	Rated current	4A
	Load voltage	12-24V DC(constant voltage)
	Safety	Short-circuit ,over voltage and over temperature protection
Connections	EIB/KNX	EIB bus connection terminal
	Inputs/outputs	Using screw terminals
Operation and display	Button and red LED	For assigning the physical address
	Green LED flashing	Indicate the application layer running normally
	LEDs for Output	Indicate output status per channel, LED on mean the channel has output, LED off mean the channel has not output.
	Manual buttons	Switch via a short operation, relative dimming via a long operation
	OT. LED	Indicate over-temperature, >70 °C
	OV. LED	Indicate over voltage, >26V DC
Type of protection	IP 20 , EN 60 529	
Temperature	Operation	-5 °C ... + 45 °C
	Storage	- 25 °C ... + 55 °C
	Transport	- 25 °C ... + 70 °C
Ambient	Humidity	<93%, except dewing
Mounting	On 35mm DIN rail	
Dimension	90×72×64.2 mm	
Weight	0.3kg	

3. Dimension and Connection Diagram

3.1 Universal Dimming Actuator

3.1.1 KA/D 0103.1

Dimension drawing:

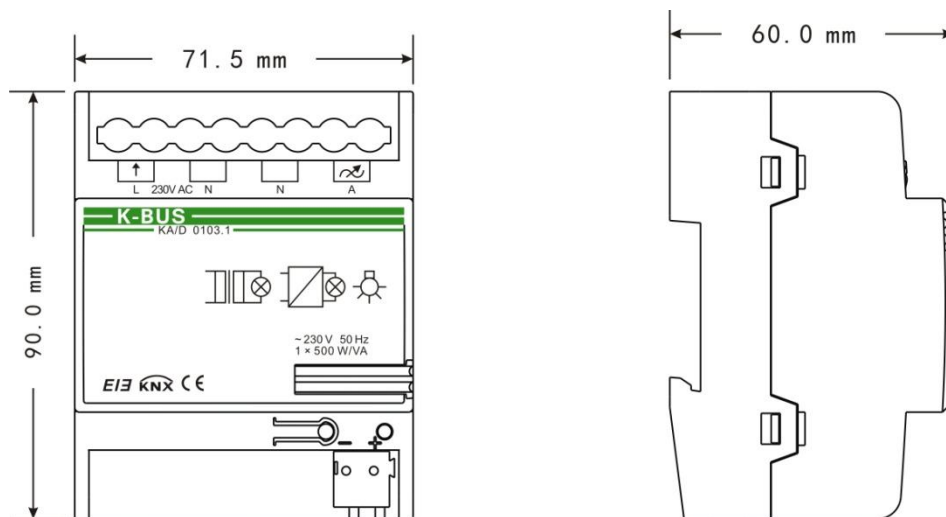

Connection Diagram:

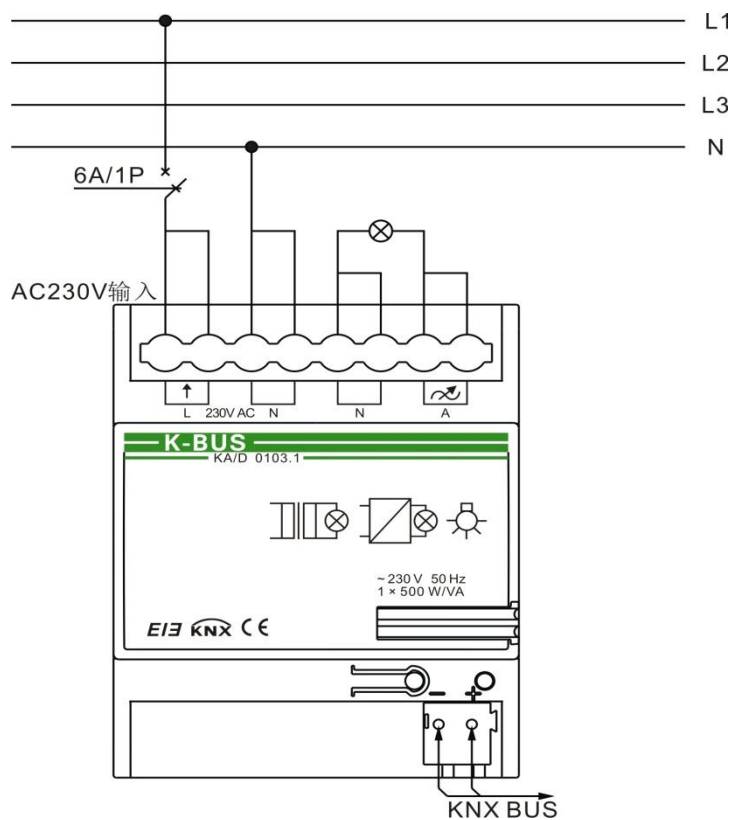

3.1.2 KA/D 0203.1

Dimension drawing:

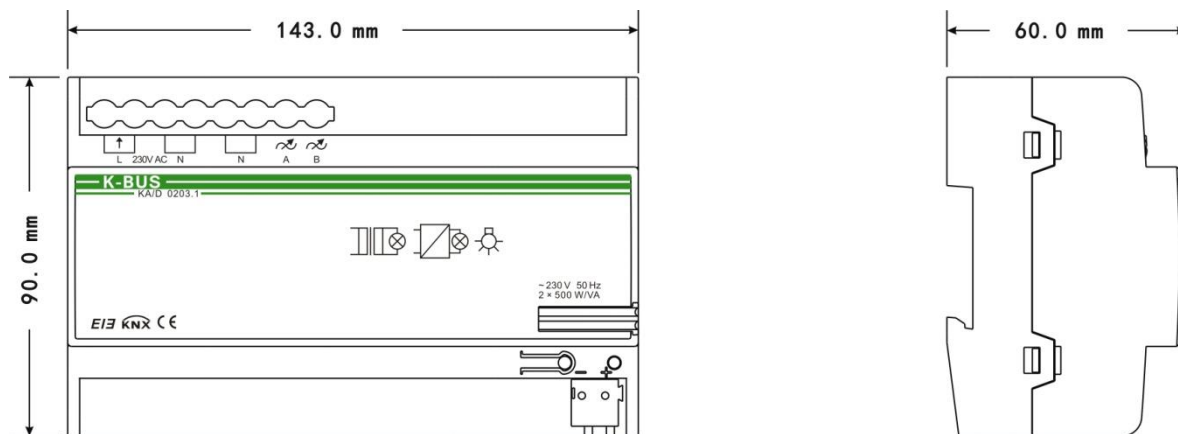

Connection Diagram:

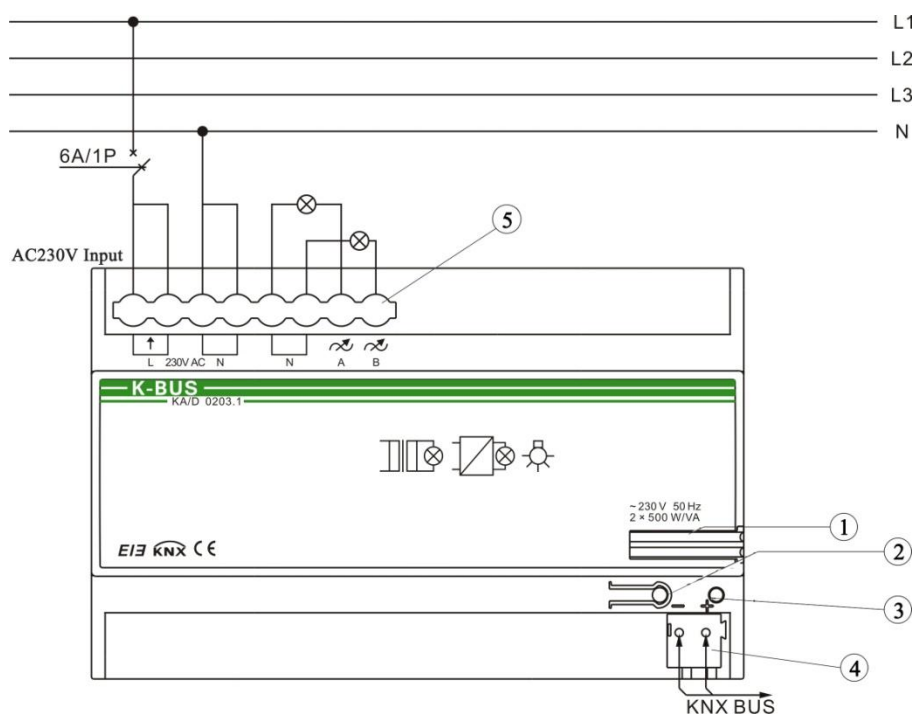

The identity of all universal dimmers is the same, take 2-flod dimmer for example:

- ① Label carrier
- ② Programming button
- ③ Red LED for entering the physical address, green LED for application layer running normally
- ④ bus connection terminal
- ⑤ input, output, load terminals

3.1.3 KA/D 0403.1

Dimension drawing:

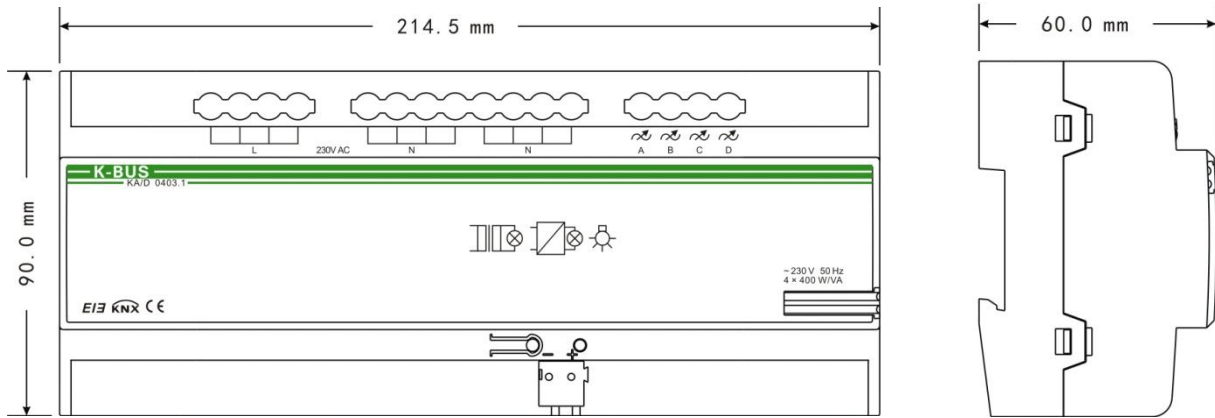

Connection Diagram:

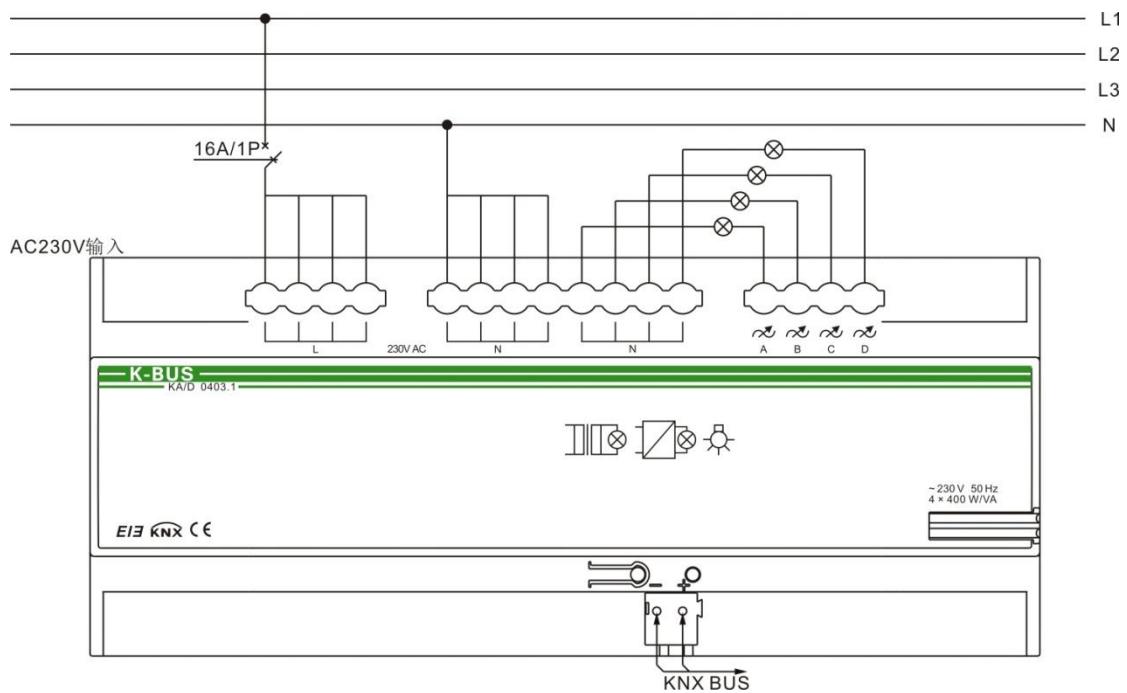

3.2 Dimming controller, 4fold, 0~10V

3.2.1 KA/D 04.T1.1

Dimension drawing:

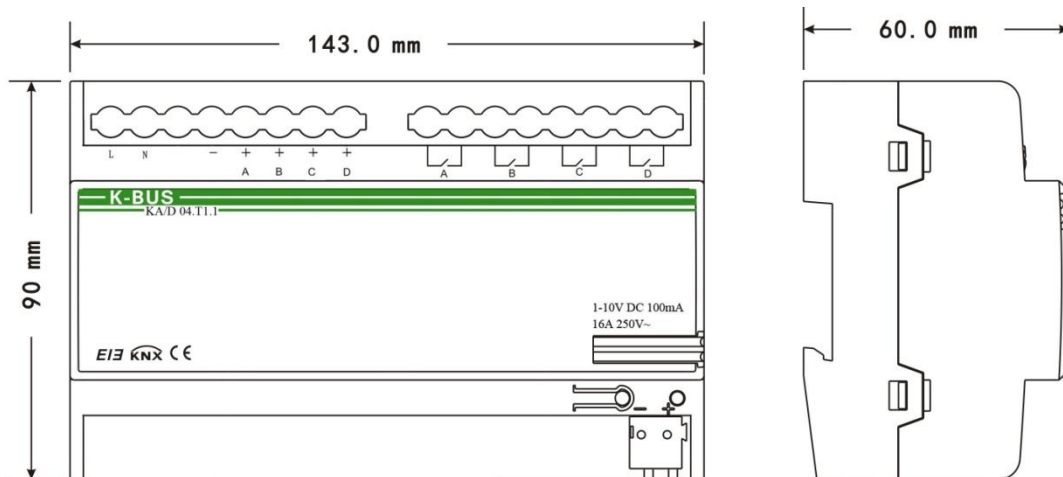

Connection Diagram:

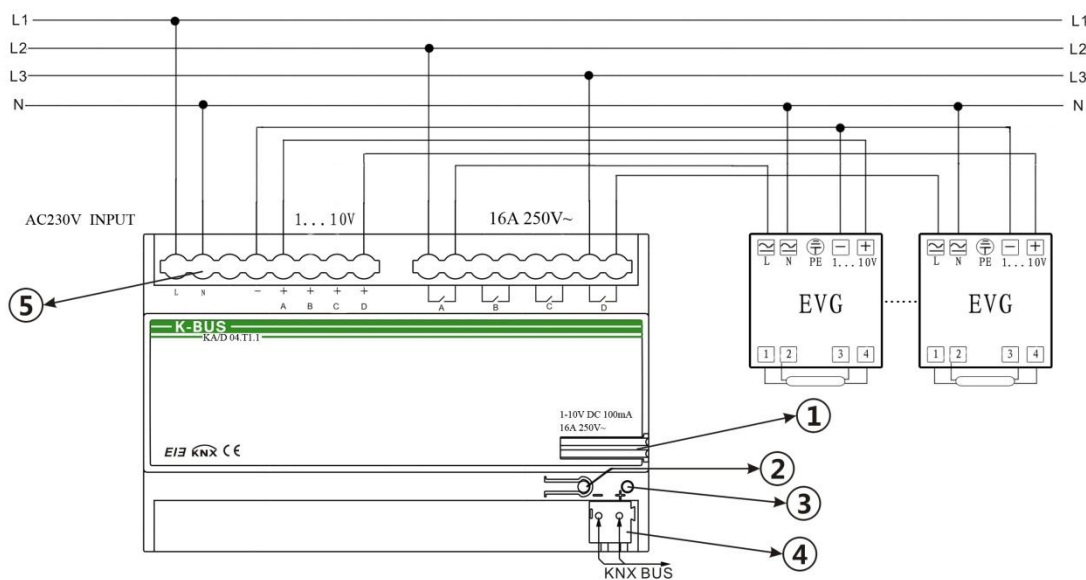

- ① Label carrier
- ② Programming button
- ③ Red LED for entering the physical address, green LED for application layer running normally
- ④ bus connection terminal
- ⑤ input, output, load terminals

3.3 Dimming controller, 4fold, 0/1~10V

3.3.1 ADTV-04/16.1

Dimension drawing:

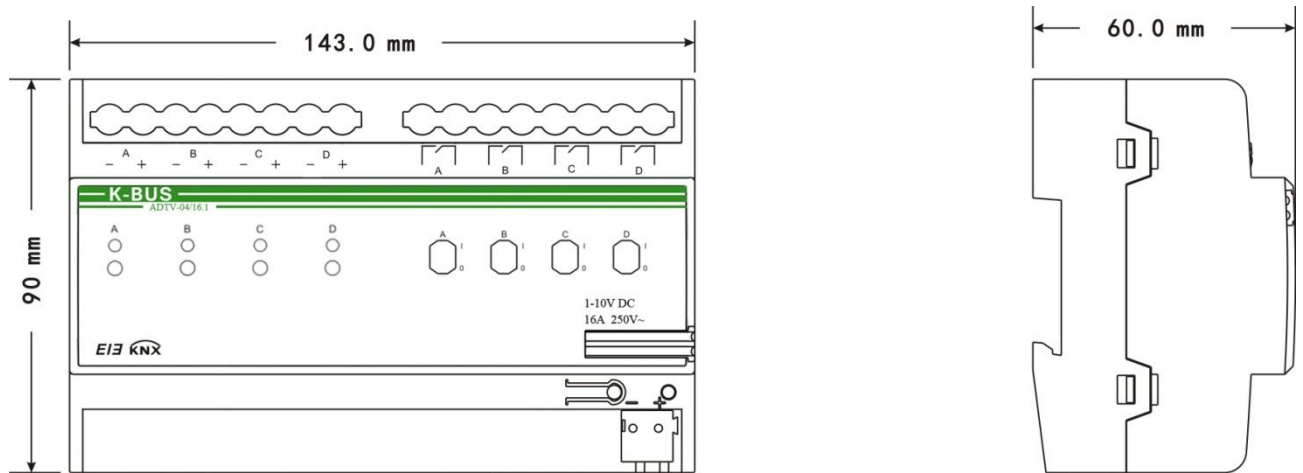

Connection Diagram:

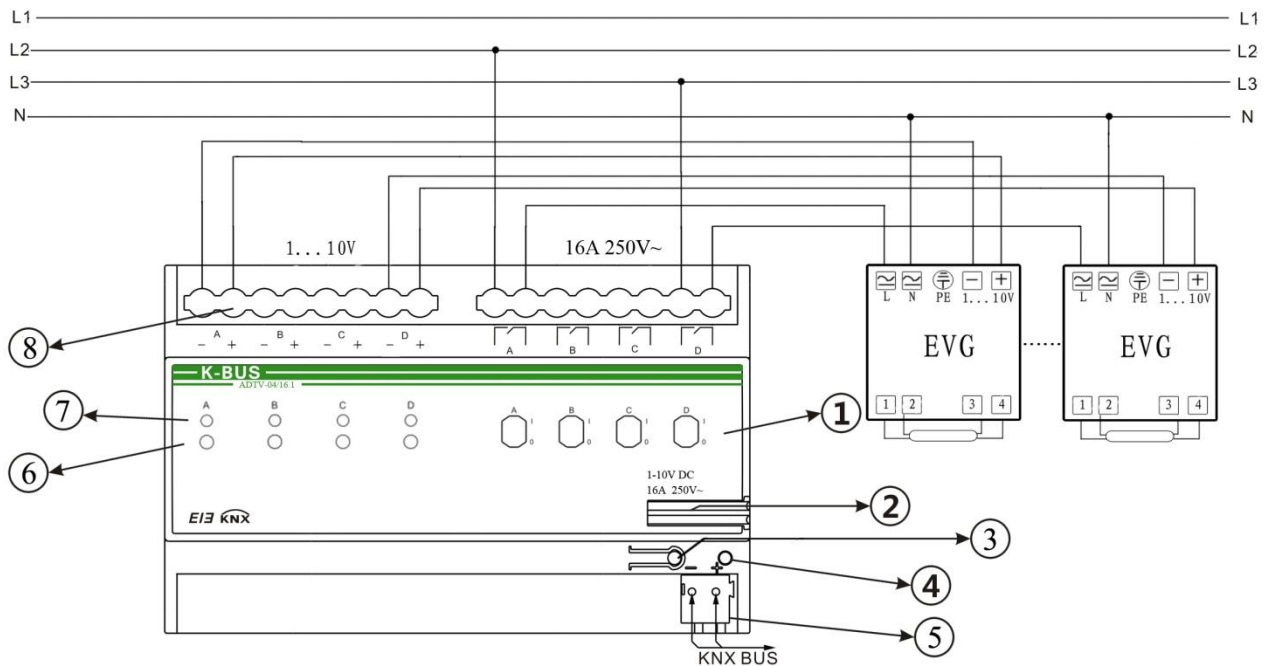

- ① Mechanical manual operation
- ② Label carrier
- ③ Programming button

- ④ Red LED for entering the physical address, green LED for application layer running normally
- ⑤ bus connection terminal
- ⑥ Electronical manual button
- ⑦ LEDs of indicating output status for each channel, LED on meaning the channel has output, or else no output
- ⑧ output, load terminals

3.4 LED Dimming Actuator, 4fold, 350mA

3.4.1 KA/D 04.L1.1

Dimension drawing:

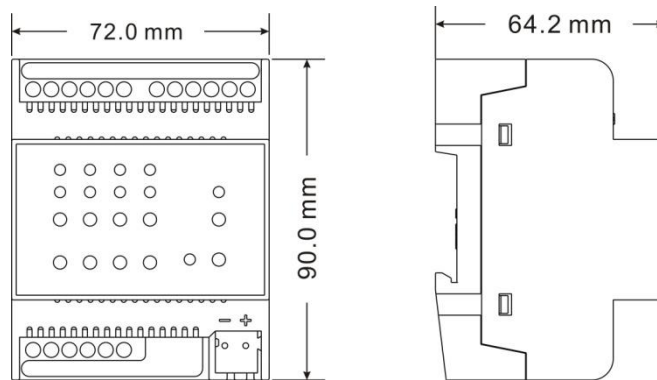

Connection Diagram:

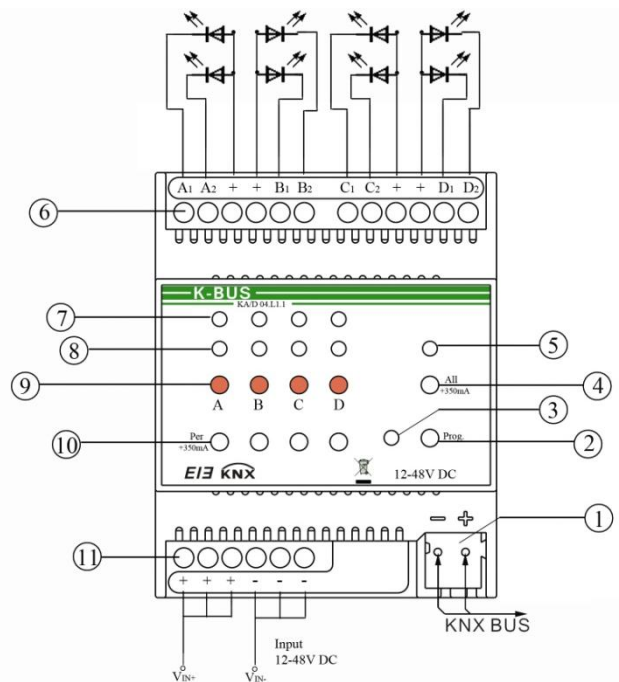

- ① EIB/KNX bus connection terminal
- ② Programming button, for assigning the physical address
- ③ Red LED for entering the physical address, green LED for application layer running normally
- ④ KEY5, switch current button for all channels, setting output current
- ⑤ LED5, indicating output current of all channels increased by 350mA
- ⑥ Output, load terminals
- ⑦ LEDs of indicating output status for each channel, LED on meaning the channel has output, or else no output
- ⑧ LED1~LED4, indicating output current of a channel increased by 350mA
- ⑨ Manual buttons, switch via short operation, relative dimming via long operation (no telegram)
- ⑩ KEY1~KEY4, switch current button for a channel, setting output current
- ⑪ Input terminals, input voltage 12~48V DC

Manually set the output current is described as follows:

Switching current button for a channel: set output current for the channel, if the button (KEY1~KEY4) is on, the output current of the channel is increased by 350mA and its LED (LED1~LED4) is on; if the button is off, the current is not increased and the LED is off.

Switching current button for all channels: set output current for all channels, if the button (KEY5) is on, the output current of all channels are increased by 350mA and its LED(LED5) is on; if the button is off, the current are not increased and the LED is off.

The button that set the output current is a dial switch, when it is toggled down, the button is on and the corresponding LED is also on; when it is toggled up, the button is off and the corresponding LED is also off. The corresponding output, dial switch and LED for each channel are as follows:

Table 1

Channel	Output	Switching current button	Indicate LED
A	A1, A2	KEY1	LED1
B	B1, B2	KEY2	LED2
C	C1, C2	KEY3	LED3
D	D1, D2	KEY4	LED4

Specific output current for each channel is controlled as shown in the table below:

Table 2

Output	Output 350mA	Output 700mA	Output 1A
A1, A2	KEY5 off, LED5 off KEY1 off, LED1 off	KEY5 off, LED5 off KEY1 on, LED1 on or KEY5 on, LED5 on KEY1 off, LED1 off	KEY5 on, LED5 on KEY1 on, LED1 on
B1, B2	KEY5 off, LED5 off KEY2 off, LED2 off	KEY5 off, LED5 off KEY2 on, LED2 on or	KEY5 on, LED5 on KEY1 on, LED1 on

		KEY5 on, LED5 on KEY2 off, LED2 off	
C1, C2	KEY5 off, LED5 off KEY3 off, LED3 off	KEY5 off, LED5 off KEY3 on, LED3 on or KEY5 on, LED5 on KEY3 off, LED3 off	KEY5 on, LED5 on KEY1 on, LED1 on
D1, D2	KEY5 off, LED5 off KEY4 off, LED4 off	KEY5 off, LED5 off KEY4 on, LED4 on or KEY5 on, LED5 on KEY4 off, LED4 off	KEY5 on, LED5 on KEY1 on, LED1 on

Note:

The low-power LED dimmer has four channels, each channel is independent and with two independent outputs. Although the two outputs are independent of each other for a channel, they are controlled simultaneously.

If outputs of the dimmer connect excessive large current LED lightings, this will lead to high heating value for the dimmer, however, when the temperature detector of the dimmer detect certain heating value, the dimming will regulate the output current, thus will affect actual brightness value of LED lighting. For example, when the heating value exceeds 75 °C, the brightness value of LED will come down, if the heating value continues to rise, the brightness value will continue to fall. The output is turned off in 90 °C. Therefore, the load of the dimmer is limited as follows:

- 1. Can connect two outputs of 1A;*
- 2. Can connect four outputs of 700mA;*
- 3. Can connect eight outputs of 350mA;*
- 4. The heating value of one output of 1A equivalent to the heating value of two outputs of 700mA;*
- 5. The heating value of one output of 700mA equivalent to the heating value of four outputs of 350mA.*

According to five above, the outputs can connect different loads in combination, for example, the dimmer can connect one output of 1A and two outputs of 700mA, or two outputs of 700mA and six outputs of 350mA etc. (Seen from table 2, the connected load is impossible occur the combination of 350mA and 1A, and the current of two outputs of each channel is the same, such as A1, A2.)

When the rated current of the load is higher than the output current of the dimmer, the brightness of load cannot reach Max value;

When the rated current of the load is lower than the output current of the dimmer, the load will burn out.

3.5 LED Dimming Actuator, 4fold, 4A

3.5.1 ADLD-04/03.1

Dimension drawing:

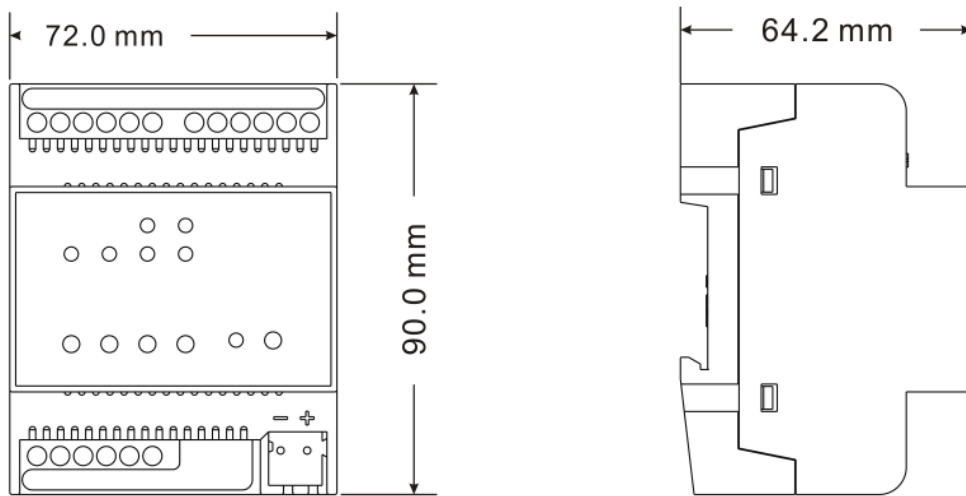

Connection Diagram:

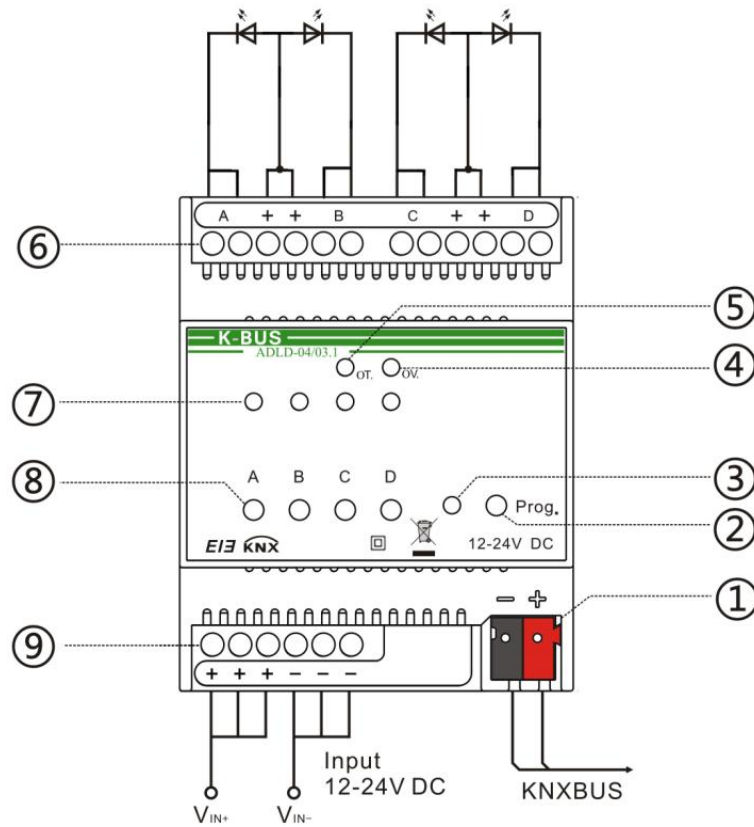

- ① EIB/KNX bus connection terminal.
- ② Programming button, for assigning the physical address.

- ③ Red LED for entering the physical address, green LED for application layer running normally.
- ④ Indicate over voltage, when the load voltage > 26V DC, the LED is ON and the output is off
- ⑤ Indicate over-temperature, when the Temp. > 70 °C, the LED is ON and the brightness value is lowered 5% per ↑ 1 °C
- ⑥ Output, load terminals.
- ⑦ LEDs of indicating output status for each channel.
- ⑧ Manual buttons, switch via short operation, relative dimming via long operation.
- ⑨ Input terminals, input voltage 12-24 V DC

4. Application Programming Introduction

It is able to set different parameters to every output channel, and control various targets by modifying the setup of the internal parameters.

4.1 Switch

The output can be switched ON or OFF by 1 bit data. It is able to set the brightness value as the last one or a defined one (1%-100%) when switching on the luminaries. It is able to set a delay time (changing time) to dim UP the luminaries or dim UP gradually in the default period. When receiving the *OFF* message, the dimmer will be switched off immediately, or dim DOWN gradually after a delay time (changing time) or in the default changing period.

4.2 Relative dimming

4 data bits control: the relative dimming command means it is possible to dim UP or DOWN to the needed brightness value during the set brightness threshold range. It is only valid to dim UP when the brightness value is smaller than the low threshold value and dim DOWN when the brightness value is greater than the high threshold value. It is also able to set whether to switch on the luminaries by the message “*dim UP to a certain value*” when the output is 0 by this function. The relative dimming is used to control the relative changes of the brightness by 4 data bits: the lowest 3 bits are controlling-bit and the highest bit is----- “1” means dim UP, “0” means dim DOWN.

Explanation of setting relative dimming: (1-7: dim DOWN; 0-8 remain unchanged (stop dimming); 9-15 dim UP)

Parameter	0	1	2	3	4	5	6	7
Dim DOWN	Unchange/stop dimming	255	128	64	32	16	8	4

Parameter	8	9	10	11	12	13	14	15
Dim UP	Unchange/stop dimming	255	128	64	32	16	8	4

4.3 Absolute dimming

8 data bits control: it is able to dim to the needed brightness value by changing the brightness parameters. The setting of the parameters is similar as relative dimming with the brightness value range: one low threshold value and one high threshold value. And it is not allowed to change the brightness value beyond the set range, the max. range is from 0 to 255. This function offers the possibility to dim UP or DOWN to 0 gradually to the target value by setting the delay time or the default time.

The high and low threshold value limits the total output of the dimmer; any brightness value beyond the range is not valid.

When the output is 0, it is able to set switching off the luminaries or remaining to a lower brightness value; and also in this status it is optional to switch on the luminaries by receiving the message “*absolute dimming*”.

4.4 Status Report

1 data bit: the dimmer offers the possibility whether sending the latest brightness value report of the controlled target and the changed report of the switch status to the BUS.

4.5 Scene

8 data bits control: the dimmer offers 15 (1-15) scenes for selection. It is possible to set ONE brightness value and the gradual change time of ON for each scene. After setting, it is easy to call any favorite scene. 1 in the highest bit of the scene command it means “saving” command, to save the current brightness value to the relevant scene.

4.6 Preset Value

The dimmer can preset scene, the object directly through 1bit data to transfer the preset scene or through 1bit data to let favorite scene to replace original preset scene. There are two preset values per output, there are two brightness values can be transfer for each preset value. Such as in theater, we need a relatively bright lighting effect when coming in, we can through transfer the first brightness value to be achieved this effect, when the movie starts playing, we need a relatively dark lighting effect, we can through transfer the second brightness value to be achieved. We can return to the previous brightness value when the movie ended.

4.7 Staircase Lighting Function

The dimmer offers the function of staircase lighting control besides the normal lighting control.

The staircase lighting function serves to switch off the lighting directly until dimming DOWN to 20% of the brightness value after a set period. It is able to set the brightness of the luminaries, the duration of the light ON,

the time to dim down to 20% separately.

In this function, it uses 1 data bit control the targets directly by setting a permanent fixed value to the output of the staircase luminaries.

The steps of staircase lighting control: the staircase luminaries will be switched on for a certain time (this time can be set) if the controlled target receives the message of “1”; these luminaries will be switched on again when receiving another message “1” during this period. The luminaries will be switched off when they are dimmed down to 20% of the brightness value (the dim down time can be set) after this period, or switch off the luminaries by sending message “0” to the controlled target. The luminaries will be off after dimming down to 20% when receiving the message “0” (the same dimming down time as above). When enabling the function “On reception switch OBJ=0 switch off”, it is able to use the function "switch off" to turn off the output in the status of "permanent on", or change the status from "switch on" to "permanent on" (message “1” means ON, “0” means OFF).

4.8 Reset

When the BUS is power off, all the outputs are switched off; the current brightness value will be saved to the memory of the dimmer. When the BUS voltage is recovered, the brightness status may be the last brightness value, or the preset brightness value.

When the BUS is power off, it may have the following situation occurring:

In the normal mode, 2 optional behaviors after the BUS voltage recovery are: the last brightness value before power off, or the set value.

In the staircase lighting mode, the behavior after the BUS voltage recovery is: ON or OFF. No output when it is OFF; start the behavior “switch=1” when it is ON.

4.9 Error Report

The dimmer offers the possibility of reporting the error status of the system; the data type is 1 byte:

Table 3 Error report of the universal dimmer

Data bit	Bit0	Bit1	Bit2	Bit3	Bit4	Bit5
Target Name	CH 1	CH 2	CH 3	CH 4		
Function	Short circuit, over load	Short circuit, over load	Short circuit, over load	Short circuit, over load	The radiator temperature more than 70°C	The radiator temperature more than 90°C

Table 4 Error report of the 350mA LED dimmer

Data bit	Bit0	Bit1	Bit2	Bit3	——	——
Target Name	B, C channels	B, C channels	A, D channels	A, D channels	——	——
Function	The radiator temperature more than 75℃	The radiator temperature more than 90℃	The radiator temperature more than 75℃	The radiator temperature more than 90℃	——	——

Table 5 Error report of the 4A LED dimmer

Data bit	Bit0	Bit1	Bit2	Bit3	Bit4	Bit5
Target Name	A channels	B channels	C channels	D channels	Device	Device
Function	The radiator temperature more than 75℃	The radiator temperature more than 90℃	The radiator temperature more than 75℃	The radiator temperature more than 90℃	Overvoltage, the input>26V DC	Over-temperature,>70℃

4.10 Normal operation signs

1 bit data. The sign will be report periodically to the Bus when the dimmer is working normally.

5. Parameters Setup Description

5.1 Introduction

2 operation modes (main function) per output:

Normal Dimming

This mode is mainly used to control the normal luminaries system, which can set the output time and the brightness value of the dimmer, dim UP or DOWN with the function of “*relative dimming*”, and also call the set brightness values from the scene function, until dim to the required environment.

Staircase Lighting

The mode is mainly used to control the staircase luminaries. Switch ON the staircase luminaries and switch OFF automatically after a certain period, or switch OFF by manually.

5.2 Parameter Window “Device general”

The parameter settings may have difference for different devices. If the device has not the follow parameters, it will have not the function of the parameter.

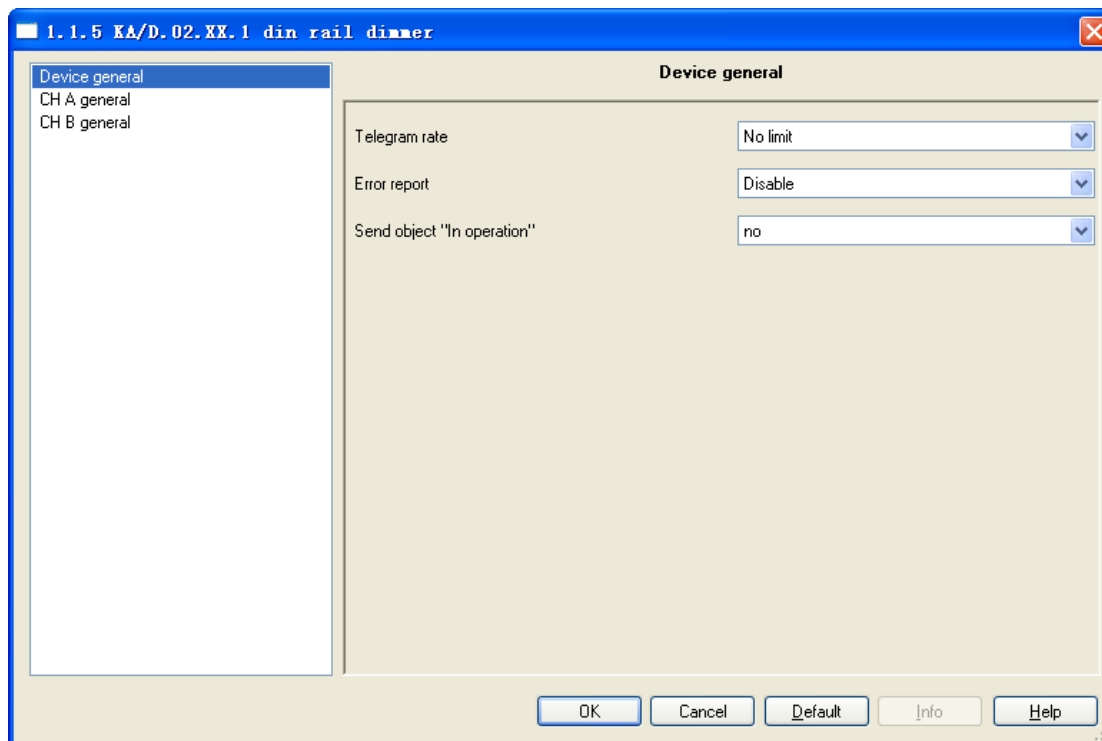

Fig. 6.1 Parameter window “Device general”

“Telegram rate”

This command is used to set the frame speed.

Options: *No limit*

Delay 100ms

Delay 200ms

.....

Delay 700ms

In this system the function of frame speed is unavailable.

“Error report”

This parameter defines the error report status of the system, controlled by 1 byte data bit.

Options: *Disable*

Enable

There is an error report after the malfunction in the system when selecting “*enable*”, otherwise, there is no report when selecting “*disable*”. It will send an alarm to switch off the device if with over temperature, overload or short circuit.

In the case of the universal dimmers, the stabilization time of temperature is 1min. in the program application. When the temperature is higher than 70 °C lasted for more than 1min., the dimmer changes its output into 30% of the current brightness; when the temperature dropped to 60°C, the dimmer changes its output into 50% of the current brightness. When the temperature is higher than 90°C lasted for more than 1min., the output turns off and cannot start, until the temperature drops below 90°C the output can be restart via sending the output command. If the temperature fluctuations at the critical point, the stabilization time will re-timing. Only when the stabilization time (1min.) has elapsed, the current output brightness changes.

In the case of the 350mA LED dimmer, when the radiator temperature is higher than 75 °C, the brightness value of LED lighting will come down, if the temperature continues to rise, the brightness value will continue to fall. The output is turned off in 90°C.

Note: the 350mA LED dimmer only report over temperature. Because of constant current output, there is not overload, if short-circuit, automatic disconnect output, but no report.

In the case of the 4A LED dimmer, when the radiator temperature is higher than 70 °C, the brightness value of LED lighting will lowered 5% per $\uparrow 1\text{ }^{\circ}\text{C}$, if the temperature continues to rise, the brightness value will continue to fall. The output is turned off in 80°C.

“Sending cycle time in s[1...65535]”

This parameter defines the time interval that the dimmers send the error report by the bus, which will be started when enabling the error report.

Options: *1.....65535s*

“output voltage type”

This parameter is used to set the output voltage type of 0/1-10V DC dimming controller. Options:

0-10V

1-10V

“Send object “in operation”

This command is used to send messages “1” or “0” to the BUS periodically to check the device whether is working or not.

Options: *No*

Send value “0” cyclically

Send value “1” cyclically

It will not send any telegram with “No”; and show the following parameters with “*Send value ‘0’ cyclically*” or “*Send value ‘1’ cyclically*” to define the time interval of sending telegram.

Sending cycle time in s[1..65535]

This parameter defines the time interval of the telegram to report the normal working condition of the dimmer.

Options: *1...65535s*

5.3 Parameter Window “CH X active”

The parameter window of “CH X active” can be seen in Fig. 6.2, which activate or deactivate the output of Channel X. The “CH X” or “X” in the following text means any one output of the dimmers. The functions are describes as below and all the channels have them same functions setup.

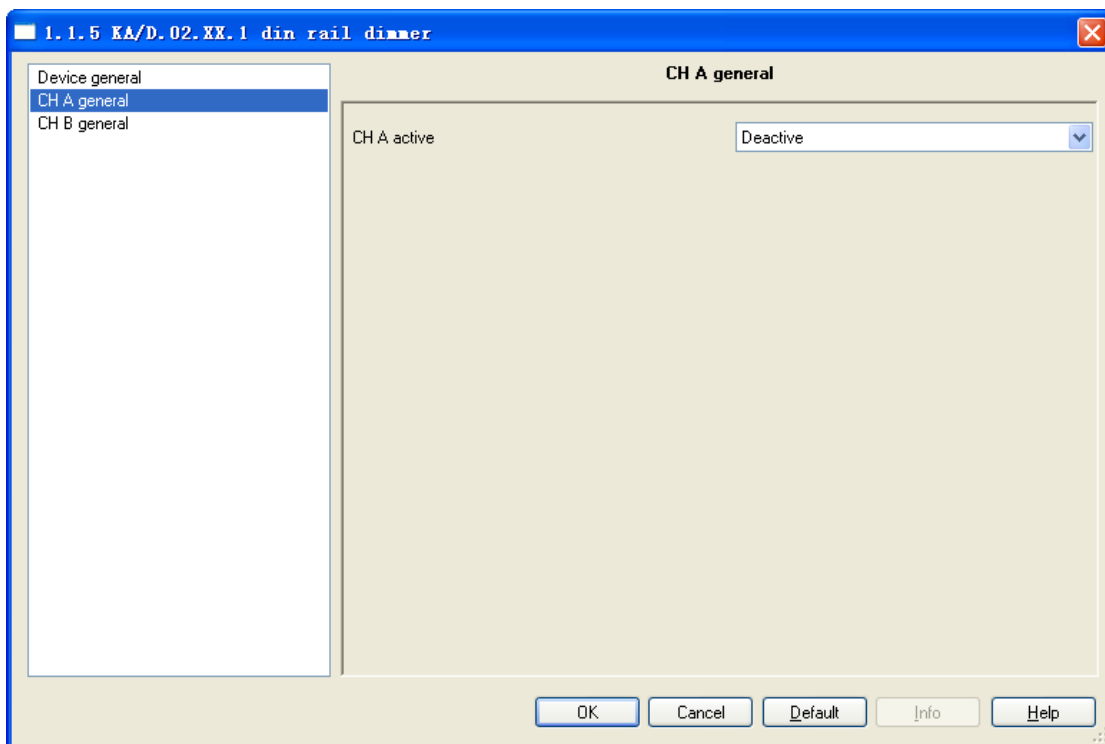

Fig. 6.2 Parameter window “CH X active”

“CH X active”

Options: *Activated*

Deactive

The window shown in Fig. 6.3 will pop out when choosing “*Activated*”. In this window, it is able to set the working mode, the current brightness status and the switch status report. It will become null with “*Deacitved*” selection.

5.4 Parameter Window “CHX general”

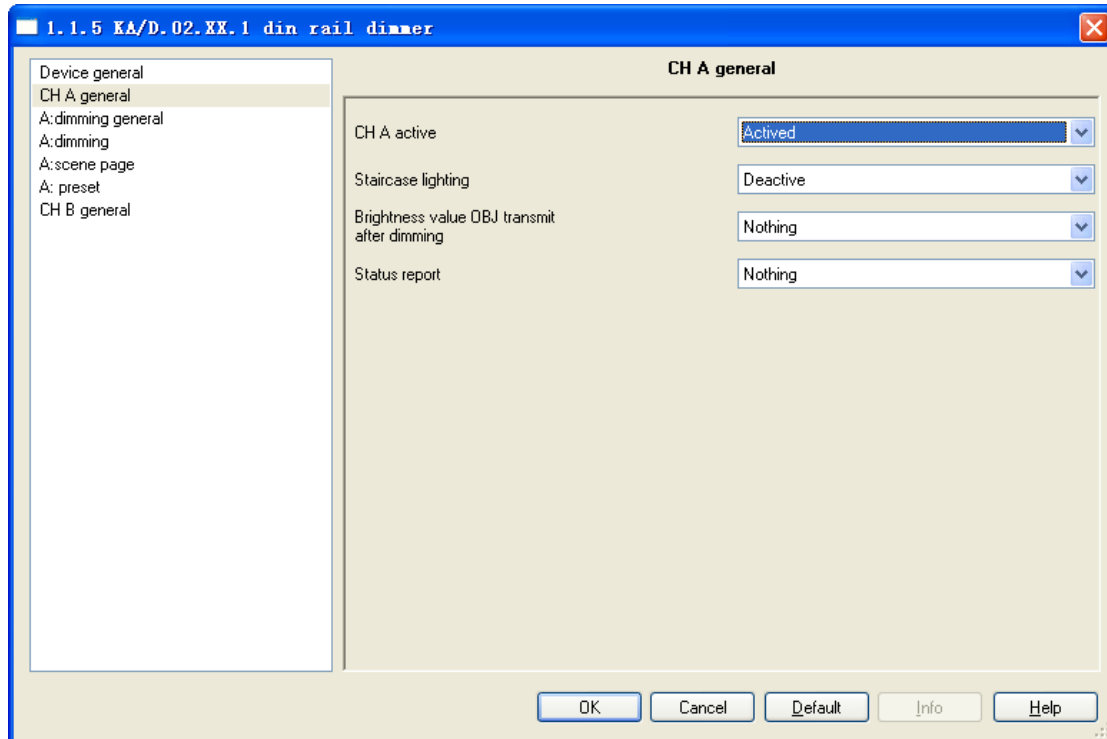

Fig. 6.3 Parameter window “CH X general”

“*Staircase lighting*”

Options: *Activated*

Deactive

It is in the status of staircase lighting control with “*Activated*” and in the normal dimming control with “*Deactive*”.

“*Brightness value OBJ transmit after dimming*”

This function is used to report the latest brightness value. When enable this function, it will send a frame to the BUS no matter what happen to make the brightness value changed.

Options: *Nothing*

Transmit new brightness

It will not send any report of the current brightness value with “*Nothing*”. And send a frame to the BUS to report the current brightness value no matter what happens to make the brightness value changed with “*Transmit new brightness*”.

Note: if selected “transmit new brightness”, the object “Brightness status X” and object “Brightness X” cannot be linked together by a same group address, or lead to the device internal loopback, and enter into endless loop, to make the bus system crash.

“Status report”

This function defines whether report the switch status to the BUS when the setup object “*switch*” is changed. Send “*1*” to the BUS when the current brightness value is greater than 0; send “*0*” when the value is equal to 0.

Options: Nothing

It’s new status

It will not send any report of the current switch status with “*Nothing*”. And send a status changed report of switch to the BUS with “*It’s new status*”.

Note: if selected “it’s new status”, the object “Switch status X” and object “Switch X” cannot be linked together by a same group address, or lead to the device internal loopback, and enter into endless loop, to make the bus system crash.

5.5 Parameter Window: dimming general

5.5.1 Setting of “CH X dimming general”

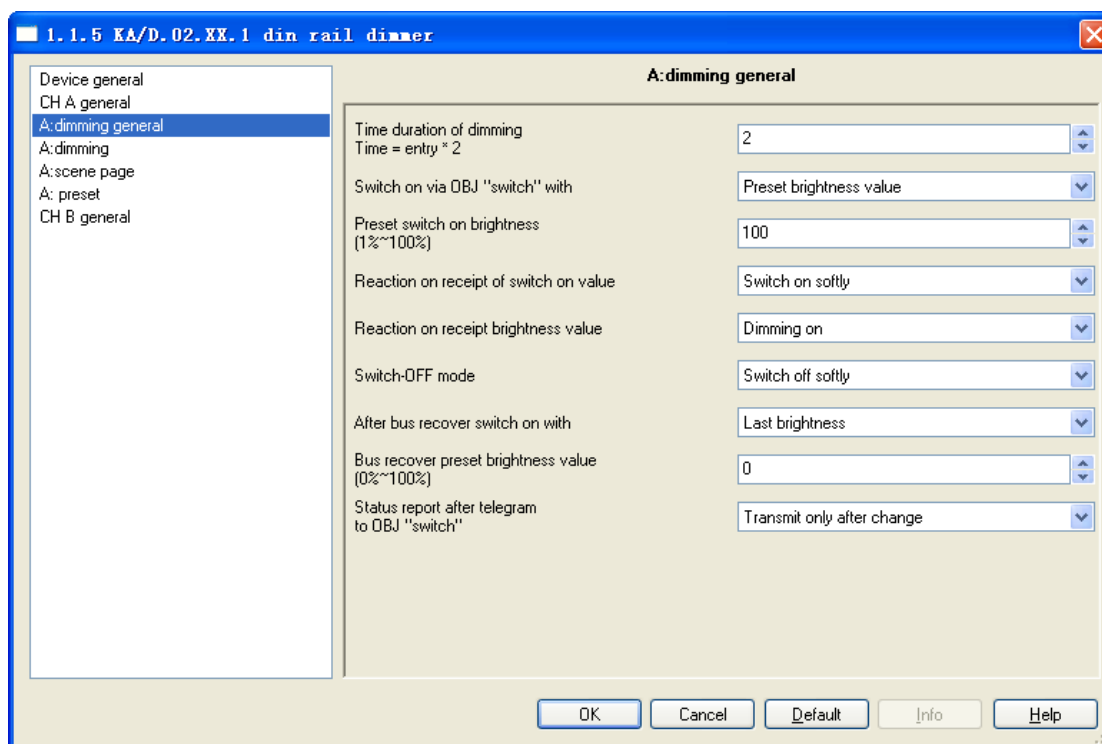

Fig. 6.4 Parameter window “CH X dimming general”

“Time duration of dimming time=entry*2”

It is used to set the dimming time duration. No matter it is brightness dimming or switch dimming, when choosing the dimming time duration for dimming on or dimming off, the time is equal to this input value multiply 2 seconds, and the maximum input time is 255s.

“Switch on via OBJ “switch” with”

It is used to select the brightness value is the last one or the preset one when using the switch mode to switch on the luminaries.

Options: *Preset brightness value*

Last brightness value

The option “*Preset brightness value*” means the brightness value is the preset value when switching on the luminaries by switch mode. When the brightness low threshold value is greater than the switch preset value, the brightness value of the luminaries is the low threshold value after switching on; when the switch preset value is greater than the high threshold, the brightness value is the high threshold one after switching on. The high and low

threshold of the brightness are shown in the parameter window “*CH X dimming*”, see Fig. 6.5.

The option “*Last brightness value*” means the brightness value is the last status’ value which is not equal to 0. If the behavior of switching on the luminaries in switch mode after the BUS reset, and the luminaries during BUS reset are off, so the brightness value is the default brightness value 128; Other cases, the brightness value is the last status’ value which is not equal to 0 on switching mode.

“Preset switch on brightness(1%~100%)”

It is used to set the brightness value when switch on the luminaries in switch mode, with the setting range 1%~100%.

“Reaction on receipt of switch on value”

It shows the time duration to switch on the luminaries in switch mode.

Options: *Dimming on*

Switch on softly

The option “*Dimming on*” means the switch dimming time is the input time multiplies 2. Then option “*Switch softly*” means the default dimming time is 4s.

“Reaction on receipt brightness value”

It is used to set the brightness value in the brightness dimming mode.

Options: *Dimming on*

Switch on softly

The option “*Dimming on*” means the brightness dimming time is the input time multiplies 2. Then option “*switch softly*” means the default dimming time is 4s.

“Switch-off mode”

It shows the time duration to switch off the luminaries in switch dimming mode.

Options: *Dimming off*

Switch off softly

Switch off instantly

The option “*Dimming off*” means the switch dimming time is the input time multiplies 2. The option “*switch softly*” means the default dimming time is 4s. The option “*switch off instantly*” means the luminaries are switch off immediately.

“After bus recover switch on with”

It means in the normal situation, the behavior after the BUS reset is the brightness value before power off or the preset value.

Options: *Preset brightness value*

Last brightness value

The option “*Preset brightness value*” means the brightness value after the BUS power recovers is the input preset brightness value in the “*bus recover preset brightness value (0%~100%)*”. If the input preset value is smaller than the low threshold, the value after the BUS power recovery is the low threshold; if the preset input value is greater than the high threshold, the value after the BUS power recovery is the high threshold. The high and low threshold are shown in the parameter window “*CH X dimming*”, see Fig. 6.5.

The option “*Last brightness value*” means the brightness value is the last value before power off after BUS power recovery. It also carry out a bus reset operation after downloading the parameters.

“Bus recover preset brightness value(0%~100%)”

It is used to set the brightness value during the BUS power recovery, and the range is 0% ~ 100%.

“Status report after telegram to obj “switch””

It is a backup parameter, do not care it.

5.5.2 Parameter Window “X: dimming”

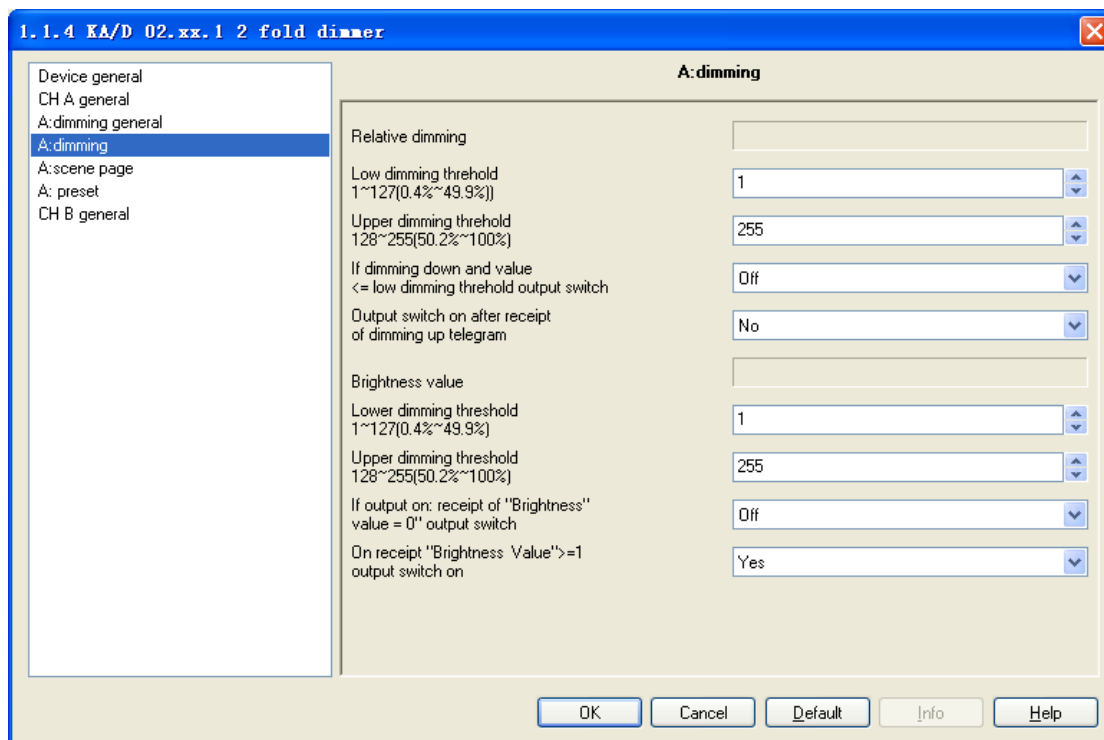

Fig. 6.5 Parameter window “X: dimming”

This window is used to set the parameters in the brightness dimming mode. There are 2 type of brightness dimming mode: *Relative dimming* and *Brightness value*:

Relative Dimming

“low dimming threshold 1~127 (0.4%~49.9%)”

This parameter defines the low threshold value of the relative dimming. When it is smaller than the low threshold, it is not allowed to dim DOWN, only to dim UP, the range is 1~127 (0.4%~49.9%). Supposing the low threshold is 50, if the current brightness value is smaller than 50, so it is not allowable to dim DOWN until dimming UP to above 50.

“upper dimming threshold 128~255 (50.2%~100%)”

This parameter defines the high threshold value of the relative dimming. When it is greater than the high threshold, it is not allowed to dim UP, only to dim DOWN, the range is 128~255 (50.2%~100%). Supposing the high threshold is 200, if the current brightness value is greater than 200, it is not allowable to dim UP until dim DOWN to below than 200.

“If dimming down and value <=low dimming threshold output switch”

This parameter defines the action after relative dimming, whether it will be off or stay in the low threshold value.

Options: *Off*

To low threshold value

Supposing the low threshold is 50. If it is “*Off*”, it will switch off the luminaries when dim DOWN to 50; if it is “*To low threshold value*”, the value of the luminaries will remain the same even when dimming DOWN to 50. However, no matter whether it is “*Off*” or “*To low threshold value*”, if the low threshold of the relative dimming is smaller than that of the brightness, it will switch off the luminaries automatically when dimming DOWN to the low threshold of the brightness value; if the high threshold of the brightness is less than relative high threshold, it is only possible to dim UP to the high threshold of the brightness. (The high and low threshold value will limit the total brightness value of the dimmer, see more details in the below description.)

“Output switch on after receipt of dimming up telegram”

It tells that whether it is possible to switch on the luminaries when receiving the “*dimming up*” message from relative dimming if the output is 0.

Options: *No*

Yes

Supposing the current output is 0. If it is “NO”, the output still remain 0 even when the target receives the message “*dimming UP*”; if it is “YES”, it will dim the luminaries to the modified value when receiving the “*dimming up*” message. If the value after dimming up is smaller than the brightness low threshold, it will be dimmed to the low threshold directly. If the value after dimming up is greater than the brightness high threshold, it will be dimmed to the high threshold directly.

Brightness Value

The high and low threshold value limits the high and low output value. It is not allowed to change the brightness value if it is beyond the high and low threshold which will be invalid. For example in Fig. 6.5 the value is set as 1~255. If the low threshold value is set as 50 and the high threshold is 200, the brightness value “210” will be invalid. The luminaries will be dimmed from the low threshold directly when the brightness value goes up from 0; the luminaries will be dimmed from the high threshold directly when the brightness values goes down from 255.

“low dimming threshold 1~127 (0.4%~49.9%)”

This function defines the low threshold of the dimmer, and the range is 1~127. It is going to start dimming from the low threshold. Supposing the current brightness value is 0; the low threshold is 50 and the high threshold is 200. If receiving the message “30”, the brightness value will go to 50 directly without gradual change; if receiving the message “60”, so the brightness value will first go to 50 and then go up to 60 gradually; if the current value is 100 and the target value is 30, so the value will go from 100 to 50 and the brightness value is 50.

“upper dimming threshold 128~255 (50.2%~100%)”

This function defines the high threshold of the dimmer, and the range is 128~255. Supposing the low threshold is 50, and the high threshold is 200. If the input brightness value is greater than 200, it will go to 200 directly.

“If output on : receipt of “brightness value=0”output switch”

This function defines it is available or not to switch off the output by the defined brightness vale “0”.

Options: *Off*

To low threshold value

The option “*Off*” means the output is 0 when the brightness value is 0. The option “*To low threshold value*” means the output is the low threshold when the value is 0.

“On receipt “brightness value”>=1 output switch on”

This function defines it is available or not to switch on the output by brightness dimming mode when the output is 0.

Options: *No*

Yes

The option “*No*” means the dimmer remains the output “0” when receiving the message of 100 if the output is 0. The option “*Yes*” means the output is the input brightness value when the receiving value is greater or equals to 1; if the input brightness value is smaller than the brightness low threshold, the output is the brightness low threshold.

5.5.3 Parameter Window “X: scene page”

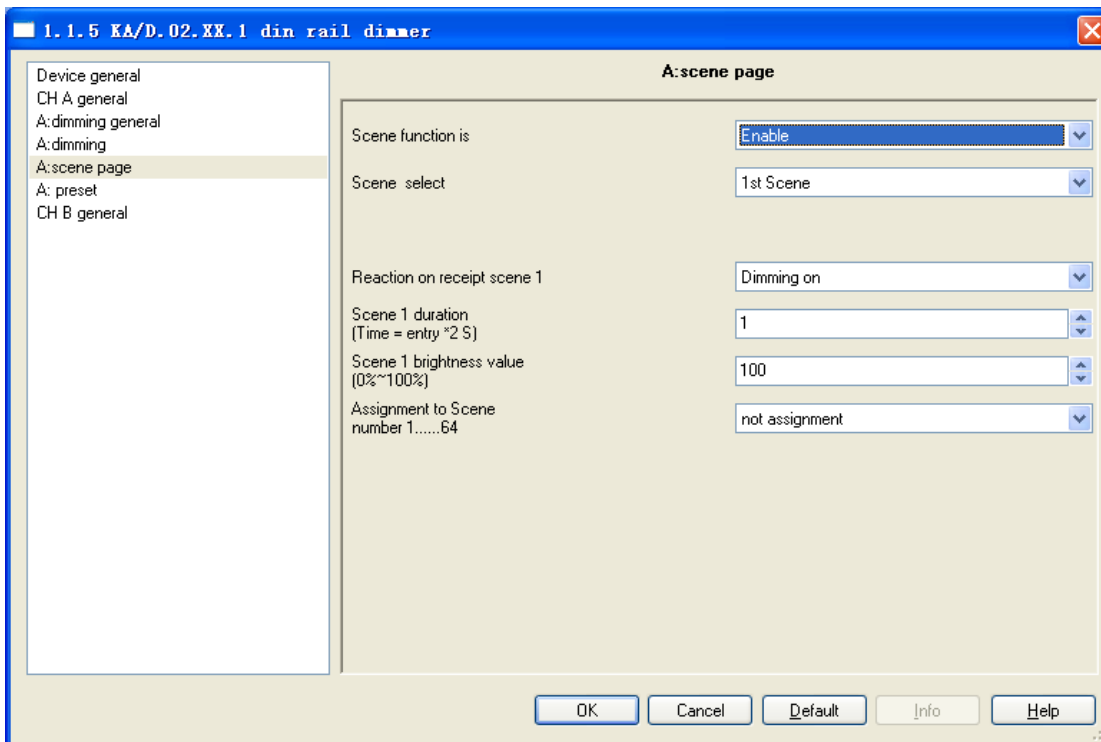

Fig. 6.6 parameter window “X: scene page”

This parameter shown in Fig. 6.6 defines the scene function, totally 15 scenes from 1 to 15. It is able to set 15 scenes simultaneously and call any one of them by control panel when needed.

“Scene function is”

The function defines the enable or disable of the scene function.

Options: *Enable*

Disable

The option “*Enable*” means it is able to use the scene function of the dimmer X; the window shown in Fig. 6.6 will be displayed after selecting. If there is no need to use the function of scene, so select “*Disable*” option.

“Scene select”

This function is used to select a scene to set the brightness value, dimming time and dimming mode.

Options: *Scene 1*

Scene 2

.....

Scene 15

The setting parameters for the other 15 scenes are shown as below:

“Reaction on receipt scene Y”

The function defines the dimming mode of the set scene. Y means the scene that needs setting, 1~15. The Y shown as below has the same meaning.

Options: *Dimming on*

Switch on softly

The option “*Dimming on*” means the set scene dimming time is the set time of the parameter “*Scene Y duration (time=entry*2s)*”: the input time multiplies 2. The option “*Switch on softly*” means the scene dimming time is the default time “*4S*”.

“Scene Y duration (time=entry*2 S) ”

This function defines the dimming time of the set scene, which is the input value multiplies 2s; the maximum input time is 255s.

“Scene Y brightness value (0%~100%) ”

This function defines the brightness value of the set scene, with range from 1% to 100%.

“Assignment to Scene number 1..64”

This function distributes the scene number of the set scene that means the communication object “*Scene/save X*” will call the scene by the allocated scene number.

Options: *Not assignment*

Assignment to scene 1

Assignment to scene 2

.....

Assignment to scene 64

Note: the parameter setting option is 1~64 field number or unallocated.

5.5.4 Parameter Window “X: preset”

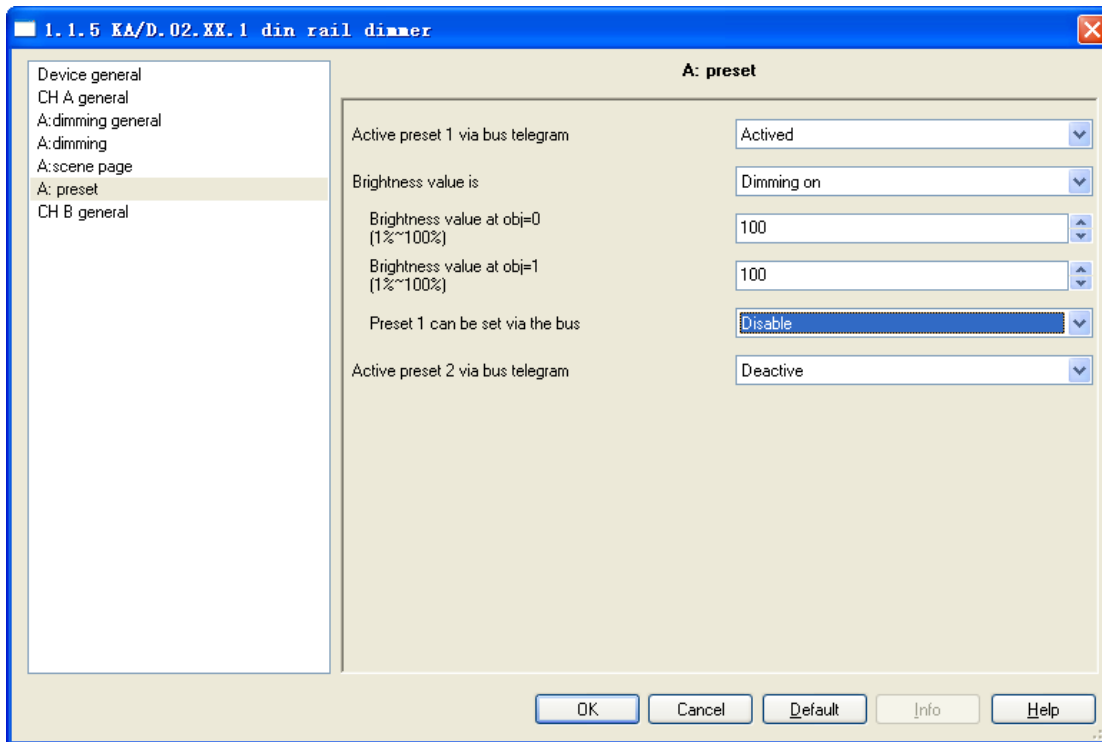

Fig. 6.7 parameter window “X: preset”

It is able to set the brightness value in “X: preset” shown in Fig. 6.7. There are two preset objects per output: “*preset 1*” and “*preset 2*” which are used to realize the lighting control. It is also able to save the current brightness status as the new preset value. These 2 preset values have the same parameters setup, so here take one as an example.

“Active preset 1 via bus telegram”

This parameter is used to activate preset 1.

- Options: *Active*
Deactive

It will not activate the preset 1 with “*Deactive*”, and show the following parameter with “*Active*”.

“Brightness value is”

This parameter defines the time when starting the dimming by “*preset 1*”, and there is 1 bit data to control “*X preset 1*”: “*0*” and “*1*”, which is able to call 2 different brightness values.

- Options: *Dimming on*
Switching on softly

When select “*dimming on*”, the dimming time of object “*X preset 1*” is the input time of “*Time duration of dimming Time =entry*” multiplied by 2; When select “*switching on softly*”, the dimming time of “*X preset 1*” is the default value: 4 seconds.

“Brightness value at obj=0(1%~100%)”

This parameter defines the brightness value when receiving “0” by “X preset 1”.

Option: 1~100%

“Brightness value at obj=1(1%~100%)”

This parameter defines the brightness value when receiving “1” by “X preset 1”.

Option: 1~100%

“Preset 1 can be set via the bus”

This parameter defines the possibility to change the preset value. It is able change the preset value with “enable” and also start the communication object “Set preset 1”, which is used to save the current switch status as the new preset value. It will save the current brightness status to the “brightness value at obj=0” and replace that value with “0”; will save the current brightness status to the “brightness value at obj=1” and replace that value with “1”.

Options: *Enable*

Disable

5.6 Staircase Lighting Mode

It is able to set the parameters of staircase lighting mode in Fig. 6.7.

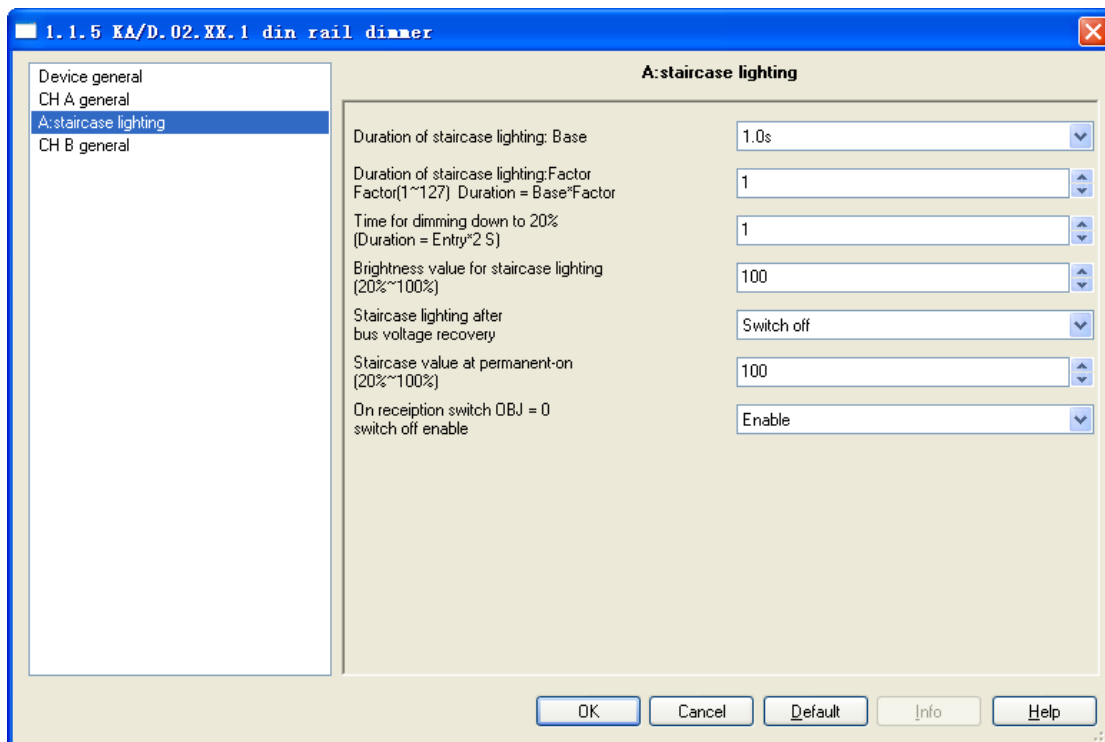

Fig. 6.7 parameter window “CH X staircase lighting”

“Duration of staircase lighting : Base”

Set the time of base: 1.0 s / 2.1 s / ... / 1.1 min / ... / 1.2 h

“Duration of staircase lighting : Factor”

Set the time of factor: 1~255 S

When switch on the staircase luminaries by “switch” mode, the ON duration time is: $duration=base*factor$. It will switch off the luminaries when the brightness goes down to 20% gradually after the ON duration time.

“Time for dimming down to 20% (Duration=Entry*2)”

This function defines the time that the brightness value of the staircase lamps goes down to 20%: $Duration=Entry*2$. The maximum input value is 255s.

The luminaries will be switched off when the brightness value of the staircase goes down to 20%.

“Brightness value for staircase lighting(20%~100%)”

The function defines the brightness value of the staircase when switching on the luminaries by “switch” mode.

“Staircase lighting after bus voltage recovery”

The function defines the status of the staircase luminaries after the BUS power recovery.

Options: *Switch on*

Switch off

The option “*Switch on*” means switch on the staircase luminaries after the BUS power recovery; $duration=base*factor$. It is to use the parameter “*Time for dimming down to 20% (Duration=Entry*2)*” to set the DOWN time. The option “*Switch off*” means switch off the staircase lamps after the BUS power recovery.

“Staircase value at permanent-on(20%~100%)”

The function defines the output status of the staircase luminaries as a fixed brightness value. It will not switch off the staircase luminaries without receiving the OFF message from “*permanent on*”. “*permanent on*” is another output mode of the staircase luminaries. The DOWN time of turning off the luminaries is set by the parameter “*Time for dimming down to 20% (Duration=Entry*2)*”. It will switch off the luminaries when going down to 20%. The range is 20%~100%.

“On reception switch OBJ=0 switch off enable”

Options: *Enable*

Disable

It is able to send off command out by “*switch*” no matter in *switch* or *permanent on* mode with “*Enable*”; but only stop outputting “*Permanent on*” by using “*permanent on*” to send OFF command in the “*permanent on*” lighting mode with “*Disable*”.

Note: In the switch output mode, it can start the “permanent on” output mode, but can’t be performed the close operation of “permanent on” when you did not start the the “permanent on” output mode.

6. Communication Object Description

Communication object is the media of devices on the bus communicate with other device, that is, just communication object can communicate with the BUS. The role of each communication objects as following. (Take 1 fold universal dimmer for example)

6.1 Communication object of “Device General”

There are 2 communication objects in "Device General" in Fig. 7.1 and functions are shown in table 7.1.

N...	Name	Object Function	Description	Group Add...	Length	C	R	W	T	U	Data Type	Priority
11	Error report	Report error of device			1 Byte	C	R	-	T	-		Low
12	In operate	In operate			1 bit	C	-	-	T	-		Low

Fig. 7.1 Communication object of “Device General”

Note: “C” in “Flag” column in the below table means that the object has a normal link to the bus; “W” means the object value can be modified via the bus; “R” means the value of the object can be read via the bus; “T” means that a telegram is transmitted when the object value has been modified; “U” means that value response telegrams are interpreted as a write command, the value of the object is updated.

No.	Function	Object Name	Data	Flags
12	In operate	In operate	1bit	C,T
<p>This object is used to declare the working condition by sending “1” or “0” to the bus cyclically, which is enabled when selecting “send value '0' cyclically” or “send value '1' cyclically” in the parameter “Send object 'in operation” and disabled when selecting “no”. It will send “0” with option “send value '0' cyclically” and “1” with “send value '1' cyclically”.</p>				
11	Report error of device	Error report	1byte	C, R,T
<p>This object is used to report the error status of the system. It will be disabled with “Error report”, and report error information when the system has the malfunction with the option “Enable”. It will also send an alarm to switch off the device with over temperature, overload or short circuit.</p> <p>Assuming an 8-bit command (telegram code) as: 76543210</p> <p>Universal dimmer</p> <ul style="list-style-type: none"> 8 bits are 0, that is the telegram "0" – the system working normally No. 0 is 1 – Channel 1 short circuit or over load No. 1 is 1 – Channel 2 short circuit or over load No. 2 is 1 – Channel 3 short circuit or over load No. 3 is 1 – Channel 4 short circuit or over load No. 4 is 1 – the radiator temperature more than 70°C No. 5 is 1 – the radiator temperature more than 90°C Other are not used <p>350mA LED dimmer</p> <ul style="list-style-type: none"> 8 bits are 0, that is the telegram "0" – the system working normally No. 0 is 1 –the radiator temperature more than 75°C for B,C channels (middle PCB) No. 1 is 1 –the radiator temperature more than 90°C for B,C channels (middle PCB) No. 2 is 1 –the radiator temperature more than 75°C for A,D channels (bottom PCB) No. 3 is 1 –the radiator temperature more than 90°C for A,D channels (bottom PCB) Other are not used <p>4A LED dimmer</p>				

8 bits are 0, that is the telegram "0" – the system working normally
 No. 0 is 1 –overload for A channel
 No. 1 is 1 –overload for B channel
 No. 2 is 1 –overload for C channel
 No. 3 is 1 –overload for D channel
 No. 4 is 1 –overvoltage for the device, the input voltage>26V DC
 No. 5 is 1 –over-temperature for the device, >70°C
 Other are not used

Table 7.1 Communication object table of Device General

6.2 General communication object of “Dimming Actuator”

N...	Name	Object Function	Description	Group Add...	Length	C	R	W	T	U	Data Type	Priority
0	OUTPUT A	Switch A			1 bit	C	-	W	-	-		Low
1	OUTPUT A	Switch status A			1 bit	C	R	-	T	-		Low
2	OUTPUT A	Relative dimming A			4 bit	C	-	W	-	-		Low
3	OUTPUT A	Brightness A			1 Byte	C	-	W	-	-		Low
4	OUTPUT A	Brightness status A			1 Byte	C	R	-	T	-		Low

Fig. 7.2 General communication object for each channel

No	Function	Object Name	Data Type	Flags
1	Switch status X	OUTPUT X	1bit	C,R,T
This object is used to report the status of the current switch to the bus. The dimmer will send “1” to the bus when the value of the brightness is larger than 0, “0” to the bus with value of “0”. The object will be enabled when selecting “It is new status” in the parameter “Status report”.				
0	Switch X	OUTPUT X	1bit	W,C
This object is used to receive the switch command to switch the dimmer actuator. It will switch on the dimmer actuator with “1”, off with “0”.				
4	Brightness status X	OUTPUT X	1byte	C,R,T
This object is used to send the brightness status of the current output to the bus whatever causes the changes of the value. The object will be enabled when selecting “Transmit new brightness” in the parameter “Brightness value OBJ transmit after dimming”.				
3	Brightness X	OUTPUT X	1byte	W,C
It is used to receive the brightness value to switch the dimmer actuator, switching on the actuator when the received value is larger than 0, off or stay to the lower threshold value with “0”, which is defined by the parameter setup in the brightness value dimming.				

2	Relative dimming X	OUTPUT X	4bit	W,C
<p>This object is used to dim up or down the outputs. It will dim down when the input value is from 1 to 7. During this range, smaller amplitude of dimming down with larger value; that means it will dim down to the biggest amplitude with 1, while to the smallest amplitude with 7, and 0 means stop dimming down. It will dim up when the input value is from 9-15. During this range, smaller amplitude of dimming up with larger value; that means it will dim up to the biggest amplitude with 9, while to the smallest amplitude with 15, and 8 means stop dimming up.</p>				

Table 7.2 General communication object table for each channel

6.3 Scene function communication object of “Dimming Actuator”

N...	Name	Object Function	Description	Group Add...	Length	C	R	W	T	U	Data Type	Priority
6	OUTPUT A	Scene / save A			1 Byte	C	-	W	-	-		Low

Fig. 7.3 Scene function communication object

No.	Function	Object name	Data type	Flag
6	Scene /save X	OUTPUT X	1Byte	W,C
<p>This object is used to send an 8bit command to transfer or save the scene. This object is opening when on enable scene function. The mean of 8bit as following:</p> <p>Set up an 8bit command (binary code) as: FXNNNNNN</p> <p style="padding-left: 40px;">F: “0” transfer scene; F: ”1” save scene;</p> <p style="padding-left: 40px;">X: Un-used, not affect the results;</p> <p style="padding-left: 40px;">NNNNNN: scene number (0...63)</p> <p>The parameter setup is 1-64.</p>				

Table 7.3 Scene function communication object

6.4 Preset value function communication object “Dimming Actuator”

N...	Name	Object Function	Description	Group Add...	Length	C	R	W	T	U	Data Type	Priority
10	OUTPUT A	Set preset 2			1 bit	C	-	W	-	-		Low
9	OUTPUT A	A Preset 2			1 bit	C	-	W	-	-		Low
8	OUTPUT A	Set preset 1			1 bit	C	-	W	-	-		Low
7	OUTPUT A	A Preset 1			1 bit	C	-	W	-	-		Low

Fig.7.4 preset function communication object

No.	Function	Object name	Data type	Flag
7	X preset 1	OUTPUT X	1bit	W,C

<p>It is the communication object of preset 1 and call the preset value. When the object receives the logical value of “0”, the brightness value of dimming are defined by “Brightness value at obj=0”; when the object receives the logical value of “1”, the brightness value of dimming are defined by “Brightness value at obj=1”. This object will be started after activating preset1.</p>				
8	Set preset 1	OUTPUT X	1bit	W,C
<p>This object is used to modify brightness value of preset1. It will start the parameter “preset1 can be set via the bus” with “Enable”. Via this object can save current brightness status as new preset value. It will save the current brightness value to ”brightness value at obj=0” with “0”, that is to replace the is value; It will save the current brightness value to ”brightness value at obj=1” with “1”, that is to replace the is value.</p>				
9	X preset 2	OUTPUT X	1bit	W,C
<p>It is the communication object of preset 2 and calls the preset value. When the object receives the logical value of “0”, the brightness value of dimming are defined by “Brightness value at obj=0”; when the object receives the logical value of “1”, the brightness value of dimming are defined by “Brightness value at obj=1”. This object will be started after activating preset 2.</p>				
10	Set preset 2	OUTPUT X	1bit	W,C
<p>This object is used to modify brightness value of preset 2. It will start the parameter “preset 2 can be set via the bus” with “Enable”. Via this object can save current brightness status as new preset value. It will save the current brightness value to “brightness value at obj=0” with “0”, that is to replace the is value; It will save the current brightness value to ”brightness value at obj=1” with “1”, that is to replace the is value.</p>				

Form7.4 Preset value function communication object

6.5 Staircase Lighting Function communication object of “Dimming Actuator”

No.	Name	Object Function	Description	Group Add...	Length	C	R	W	T	U	Data Type	Priority
0	OUTPUT A	Switch A			1 bit	C	-	W	-	-		Low
5	OUTPUT A	Permanent on A			1 bit	C	-	W	-	-		Low

Fig. 7.5 Staircase Lighting Function communication object

No.	Function	Object Name	Data Type	Flag
-----	----------	-------------	-----------	------

0	Switch X	OUTPUT X	1bit	C, W
<p>The communication object is used to switch the staircase light function of dimmer. It will switch off the staircase lighting after a certain on time, and the starting staircase lighting time are defined by “Duration of staircase lighting: Base” and “Duration of staircase lighting: Factor” and lights on duration is: duration=base*factor. It will be off automatically after some time. It will switch off the lights with “0”.</p>				
5	Permanent on X	OUTPUT X	1bit	C,W
<p>The object receives the logical value “1” to open staircase light for a long time, receives the logical value “0” to end the staircase light.</p>				

Form 7.5 Staircase Lighting Function communication object