



reddot award 2019
winner

Controlmini
HIGH-CLASS
DESIGN MEETS
FUNCTIONALITY



Built-in KNX interface



YOUVI Basic software package with
visualization and bus monitor included



Open for all Windows- and web-
based visualizations



Surface-mounted or flush-mounted

Powerful equipment

With the Controlmini you can map all functions for building control on 11.6 inches clearly at a central location. In this way, you can always keep an eye on your building technology. You can also choose from many application options, because the Controlmini is based on a fully-fledged Windows 10 computer.

It can be utilised in both the private and commercial sector – either in connection with an external server or without, thanks to its own KNX interface and the included YOUVI software. The Controlmini shows inherently high-performance and can be used for a wide range of applications: From classic home control to the use in hotels, bars or office buildings.

The Full-HD display with capacitive touchscreen, the 5 megapixel camera and the broadband loudspeakers extend the possible applications of the device, for example for video telephony or to use it as an information terminal. In addition to the basic functions of building control, the Controlmini also supports IP telephony, SIP intercoms with video transmission and other Windows features such as night light and wipe gesture control, thanks to the pre-installed Windows 10 IoT Enterprise LTSC.

The use of high-quality components

not only makes the Controlmini look elegant, but also helps to dissipate excess heat over the frame and front to the environment. This fanless cooling concept allows the noiseless operation of the panel.

Clever Software

The hardware is rounded off with the specially adapted YOUVI Basic software. The software enables you to control (RGBW) lights, blinds, temperature or switches comfortably and centrally - simply by your customizable dashboard on the touch panel.

Thanks to the intuitive interface, all functions are easily accessible and you hardly have to navigate. Customize your home control also with web widgets that let you integrate any website into the user interface.

YOUVI Basic can be expanded as needed with various add-ons. The logic module eliminates the need for many manual operations. Store morning and evening routines and play them automatically. Or create message functions, presence simulations and individual scenes. Other add-ons allow you to use additional functions: From video surveillance with IP cameras to controlling your smart home via app or voice command. With the music player for Sonos or trivium, a multi-room music control is realized, which advances the Control-

mini to an actual multimedia device.

Open for further visualizations

It is also easy to use other visualizations that run as a web application or Windows client on the Controlmini. There is a large selection here, such as CubeVision, Edomi or also visualizations of the Gira HomeServer or X1. In this way you can expand the functions of the panel according to your individual requirements.

Convenient installation

You can mount the Controlmini in three ways: Surface-mounted without chiseling or mortising, flush-mounted for a very flat look on the wall, or even completely flush with the wall. The last installation method gives the panel a particularly refined look. It can also be used as an exchange device in the flush-mounted boxes of Gira, ABB/Busch-Jaeger, Berker or Feller devices. Due to the possibility of surface mounting, old MT701 devices with UP-KAST2 flush mounted boxes are also easy to replace.

Timeless design

The glass cover is available in black and white as standard. In addition, you can design an individual glass in your preferred colour or with your own motif. For an additional charge we offer you a glass without our logo.

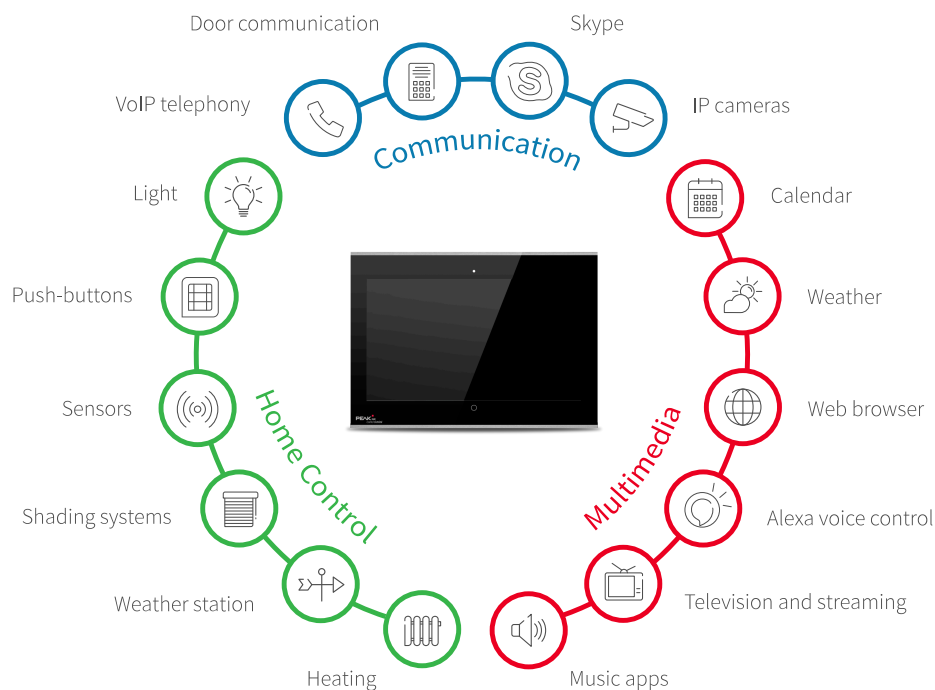

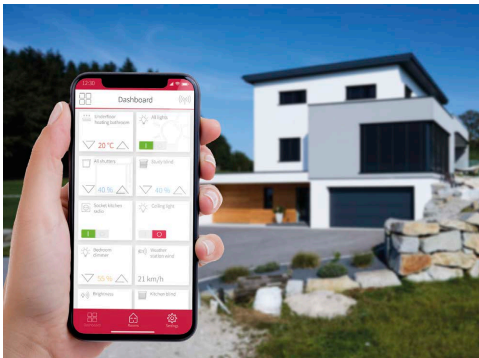
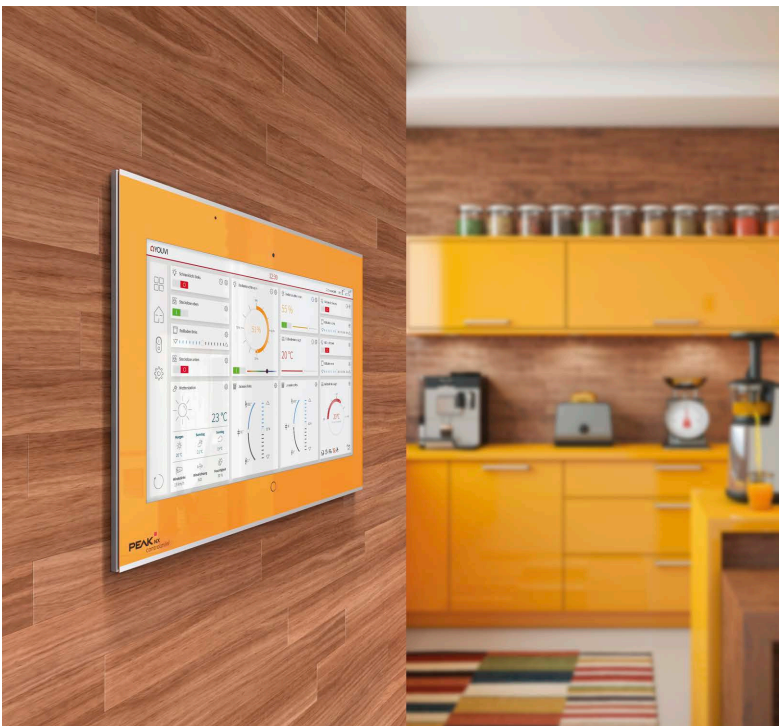

YOUVI

A visualization in which even new users find their way quickly and intuitively. The smart designed user interface shows you everything you need for uncomplicated building control.

Use the room buttons to go directly to the desired room and control lighting groups, shutters and more without having to navigate much.

The music player makes it possible to control and keep track of the music selection in each room

Use the clearly arranged navigation bar, divided into trades, floors and an individual dashboard.

In addition to controlling shutters, blinds, lights, (RGBW-) dimmers, switches and heaters, the weather station can also be easily set up and integrated.

Each tile can be displayed in two different sizes.

Various sensors for e.g. humidity, wind speed, brightness and binary sensors for window and door contacts are supported.



Automatic setup via ETS import function



Including iOS or Android app



Dashboard freely configurable via drag and drop

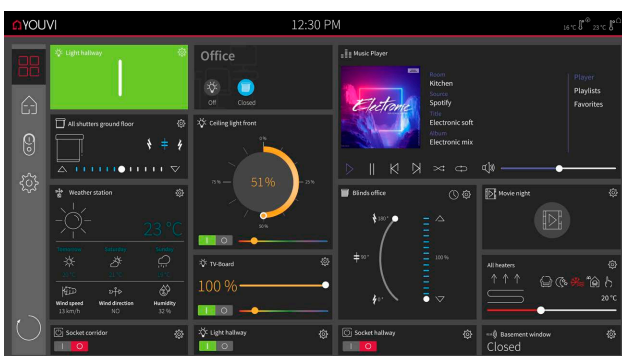

Dark Theme

You prefer darker designs? Then simply switch to Dark Mode. The dark theme not only looks elegant, it is also more gentle to your eyes in a dark environment.

	YOUVI Basic
Visualisation	✓
Bus monitor	✓
IP router	✓
Connect Module	optional
Camera Module	optional
Logic Module	optional
Door station Module	optional
Device Bridges*	optional
	YOUVI Basic is already included with PEAKnx hardware.

AS MADE FOR YOU: THE YOUVI ADD-ON IDEA

YOUVI Basic covers the most common building control tasks. Beyond that our Add-on concept offers you exactly the functions you need. Just extend the functionality of your Controlmini with additional modules and bridges according to your requirements. And best of all: You only pay for the features you really need.



Logic

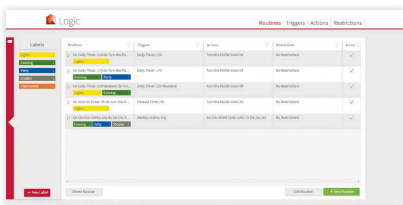

- Create individual logic: via time intervals, timers, device values or HTTP requests.
- Define labels for a better overview.



Connect

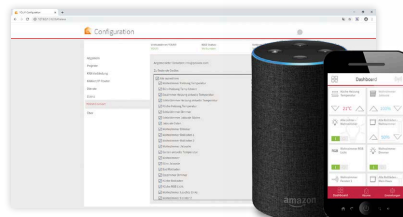

- Control your building by voice command with Alexa.
- Access the most important functions of your devices on your smartphone while on the move.



Camera

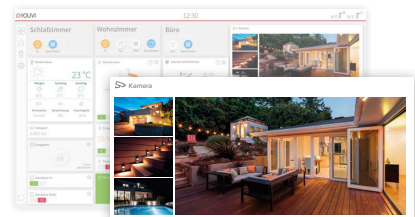

- Integrate your IP camera into the visualization.
- Define several streams simultaneously in one widget and use the full-screen display.



Door station

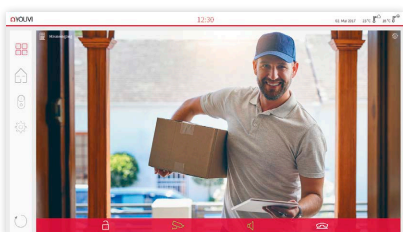

- Receive visitors over your video door station.
- Choose your preferred SIP door intercom, for example from AGFEO, Mobotix, Bird Home Automation or other manufacturers.



Bus monitor

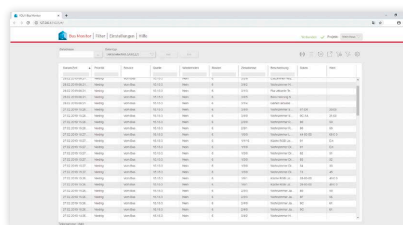

- Speed up troubleshooting by using complex filters.
- Have the data traffic on the KNX bus logged.
- Import several KNX projects simultaneously.



IP router

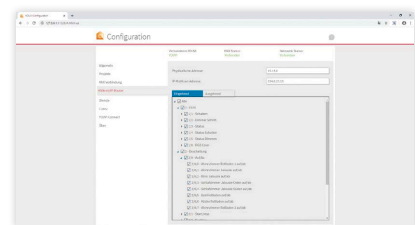

- Spare IP router hardware.
- Use up to 15 tunneling connections, multicast and extended frames.
- Benefit from KNX compatibility, e.g. for using ETS 5.

*For more information on device bridges, visit peaknx.com/youvi

AT A GLANCE

Technical data

Specification

- Intel Quad-Core processor
- 4 GB main memory
- eMMC memory with 64 GB
- 11.6 inch Full-HD LED LCD
- Multi-touch through PCAP touch technology
- 5 Megapixel camera
- Broadband stereo loudspeaker
- Optimized microphone
- WLAN, 2.4 GHz and Bluetooth 4.0
- Fanless cooling by convection

Software

- Operating system: Windows 10 IoT Enterprise LTSC
- YOUVI Basic software package consisting of visualization, IP router and bus monitor (modules and bridges can be purchased separately)

Ports

- KNX
- 2 x USB 2.0 Front port
- 1 x USB 3.0
- 1 x 100 Mbit Ethernet
- 1 x Mini HDMI out
- 1 x MicroSD card slot

Supply and consumption

- Supply voltage: 24 V (Power supply units for DIN rail and flush-mounted box available)
- Idle operation: 10 W
- Full load operation: 15 W
- Server operation without LCD: 5 W

Dimensions

- Flush-mounted box, WxHxD: 251 x 193 x 50 mm
- Glass cover, W xHxD: 297 x 210 x 0.7 mm

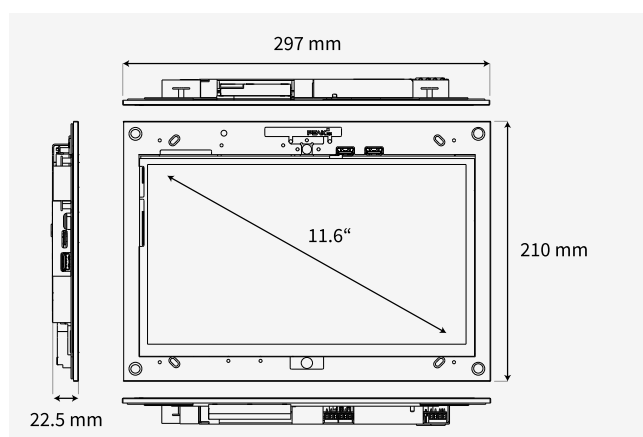

Compatibility

Visualizations

Any Windows or web-based, e. g.:

- BabTechnologie: CubeVison
- Gira: QuadClient, Ajax, X1
- Hager: Domovea
- Symcon GmbH: IP-Symcon
- Edomi, openHAB, ThinKnx and many more ...

Flush-mounted boxes

Adapter available for flush boxes, such as UP-KAST2, Jung EBG 24 or Busch-Jaeger 6136/UP, to replace e. g.:

- Gira Control 9 & InfoTerminal Touch
- Merten Touch-Panel 7
- Busch ComfortPanel 9" & 12,1"
- Berker Master Control and many more ...

Cameras

IP streams in RTSP, JPG and MJPG format, e. g. from:

- Hikvision
- Axis
- Mobotix and many more ...

Door communication

All SIP-enabled DCS, for example:

- Doorbird IP Video Door station
- AGFEO IP-Video TFE
- Wantec Monolith C IP
- Mobotix T25 and many more ...

ETS

- ETS Inside Server

Music software

- Windows or web-based software:
- Apple iTunes, Spotify, Sonos and many more ...

- Reliable, noiseless operation
- Software package YOUVI Basic for KNX bus control included, consisting of visualization, IP router and bus monitor
- KNX connection and software save external server
- Compatible with many other visualizations, SIP door stations and flush-mounted boxes
- Smooth display of surveillance cameras and other multimedia applications
- Low installation depth
- Available as surface/flush-mounted or flush with wall
- Exchangeable glass covers with individual designs