



## Controlpro

FULL CONTROL  
OVER YOUR  
SMART HOME



Built-in KNX interface



YOUVI Basic software package with  
visualization and bus monitor included



Server & IP router functionality



Open for all Windows- and web-  
based visualizations

### Powerful equipment

From classic home control to large automation projects with sophisticated SCADA systems – the Controlpro covers a wide range of applications. With three variants, which differ in their equipment depending on the required performance, the Controlpro meets the most diverse requirements of building automation. At its core, the operating panel is a powerful 18.5 inch monitoring and control unit based on a full-fledged Windows 10 computer. This means that it can not only clearly display all the functions of a building control system at a central location for you, but can also do so in your desired visualization.

The touch panel offers trouble-free operation in both the private and the commercial sector – either in combination with an external server or alone. A KNX interface and YOUVI make it possible and turn the Controlpro into much more than a simple operating device. In addition to the basic functions of building control, the Controlpro also supports IP telephony functions, SIP intercom systems with video transmission and other Windows features such as night light and wipe gesture control. Thanks to the fanless cooling, the device works completely silent.

The Controlpro is made of high-quality materials and contains the latest indus-

trial components, including a Full-HD display with capacitive touch screen, 5 megapixel camera and broadband loudspeakers. With Windows 10 IoT Enterprise LTSC the latest operating system is already pre-installed.

### Clever software

The visualization YOUVI Basic is already included in the delivery of the Controlpro. The software enables you to control (RGBW) lights, blinds, temperature or switches comfortably and centrally – simply by your customizable dashboard on the touch panel.

Thanks to the intuitive interface, all functions are easily accessible and you hardly have to navigate. Furthermore, YOUVI allows you to access any website and integrate it into the user interface. There you can arrange news or entertainment applications as you wish.

YOUVI Basic can be expanded as needed with various add-ons. The logic module eliminates the need for many manual operations. Store morning and evening routines and play them automatically. Or create message functions, presence simulations and individual scenes. Other add-ons allow you to use additional functions: From video surveillance with IP cameras to controlling your smart home via app or voice command. In combination with a net-

work TV tuner, such as the Octopus NET, and a suitable program, you can even stream TV channels on the touch panel. With the music player for Sonos or trivium, a multi-room control is realized, which advances the Controlpro to a comprehensive multimedia device.

### Open for further visualizations

In addition, it is also possible to use other visualization solutions that run as a web application or Windows client on the Controlpro. There is a large selection here, such as EisBär, CubeVision, Edomi or also visualizations of the Gira HomeServer or X1. In this way you can expand the functions of the panel according to your individual requirements.

### Convenient installation

Mount the Controlpro either in a flush-mounted box, optionally even flush with the wall, or install it as a replacement device in the flush-mounted boxes of the Gira Control 19 or Server-Client 15.

### Timeless design

The glass of the Controlpro is available in black and white as standard. You also have the option of having an individual glass designed in your preferred colour or with your own motif. For an additional charge we offer you a glass without our logo.

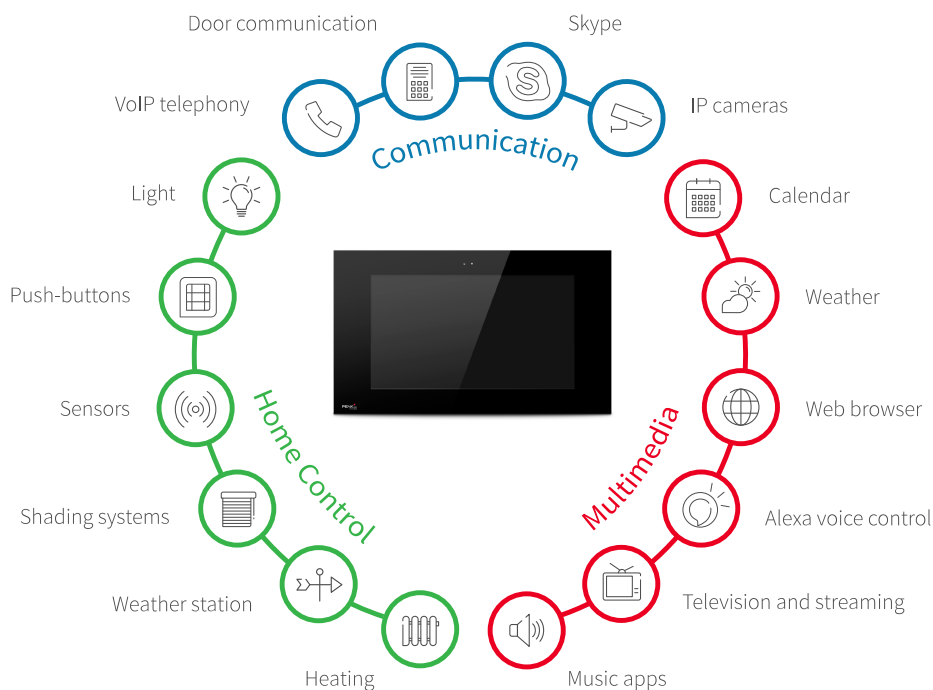





**PEAK**<sup>NX</sup>  
control pro

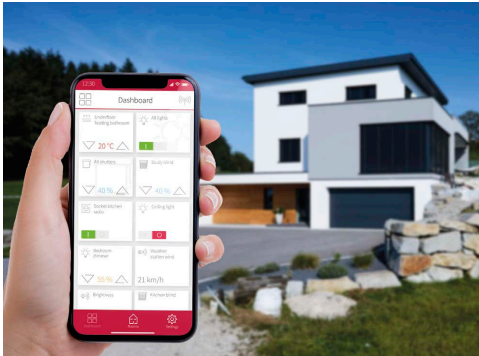
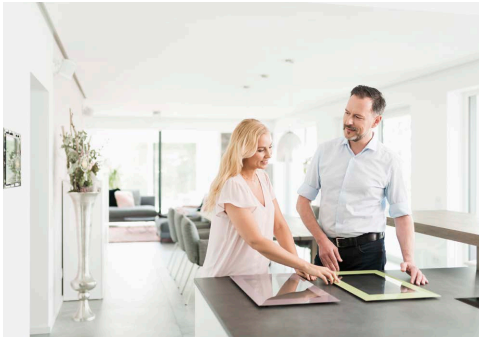

# YOUVI

A visualization in which even new users find their way quickly and intuitively. The smart designed user interface shows you everything you need for uncomplicated building control.

Use the clearly arranged navigation bar, divided into trades, floors and an individual dashboard.

In addition to controlling shutters, blinds, lights, (RGB)-dimmers, switches and heaters, the weather station can also be easily set up and integrated.

Various sensors for e.g. brightness, humidity, wind speed and binary sensors for window and door contacts are supported.

Use the room buttons to go directly to the desired room and control lighting groups, shutters and more without having to navigate much.

Keep track of your building by integrated streams of your surveillance cameras.

Each tile can be displayed in two different sizes.

The music player makes it possible to control and keep track of the music selection in each room.



Automatic setup via ETS import function



Including iOS or Android app



Dashboard freely configurable via drag and drop



## Dark Theme

You prefer darker designs? Then simply switch to the Dark Mode. The dark theme not only looks elegant, it is also more gentle to your eyes in a dark environment.

	YOUVI Basic
Visualisation	✓
Bus monitor	✓
IP router	✓
Connect Module	optional
Camera Module	optional
Logic Module	optional
Door station Module	optional
Device Bridges*	optional
	YOUVI Basic is already included with PEAKnx hardware.

# AS MADE FOR YOU: THE YOUVI ADD-ON IDEA

YOUVI Basic covers the most common building control tasks. Beyond that our Add-on principle offers you exactly the functions you need. Just extend the functionality of your Controlpro with additional modules and bridges according to your requirements. And best of all: You only pay for the features you really need.



Logic

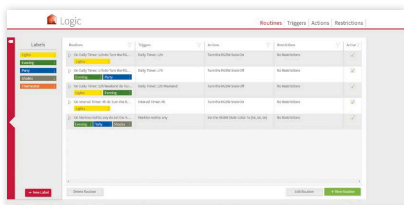

- Create individual logic: via time intervals, timers, device values or HTTP requests.
- Define labels for a better overview.



Connect

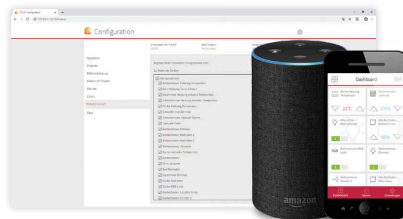

- Control your building by voice command with Alexa.
- Access the most important functions of your devices via your smartphone while on the move.



Camera

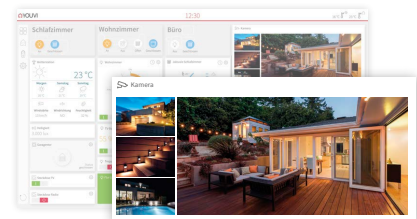

- Integrate your IP camera into the visualization.
- Define several streams simultaneously in one widget and use the full-screen display.



Door station

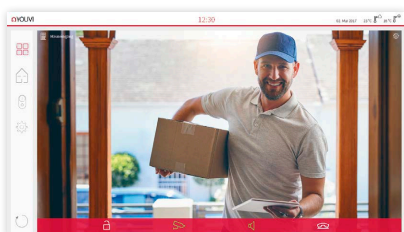

- Receive visitors over your video door station.
- Choose your preferred SIP door intercom, for example from AGFEO, Mobotix, Bird Home Automation or other manufacturers.



Bus monitor

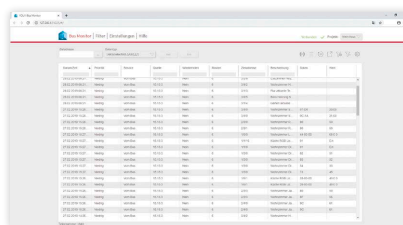

- Speed up troubleshooting by using complex filters.
- Have the data traffic on the KNX bus logged.
- Import several KNX projects simultaneously.



IP router

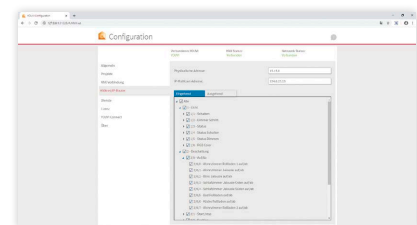

- Spare IP router hardware.
- Use up to 15 tunneling connections, multicast and extended frames.
- Benefit from KNX compatibility, e.g. for using ETS 5.

\*For more information on device bridges, visit [peaknx.com/youvi](http://peaknx.com/youvi)

# AT A GLANCE

## Technical data

### Specification

- Intel Dual-/ Quad-Core Processor
- 250 or 500 GB SSD hard drive space
- 4, 8 or 16 GB DDR4 main memory
- 18.5 inch Full-HD LED LCD panel
- Multi-touch through PCAP touch technology
- 5 Megapixel camera
- Broadband stereo loudspeaker
- Optimized microphone
- Fanless cooling by convection

### Software

- Operating system: Windows 10 IoT Enterprise LTSC
- YOUVI Basic software package consisting of visualization, IP router and bus monitor (modules and bridges can be purchased separately)

### Ports

- KNX
- 2x USB 2.0 front port
- 4x USB 3.0
- 1x GB LAN
- 1x HDMI Out
- 1x Line Out
- 1x Mic In

### Supply and consumption

- Supply voltage: 15 - 20 V DC (Power supply units for DIN rail and flush-mounted box available)
- Max. current in operation: 4 A, PC boot process: 4.5 A
- Average power consumption: 40 W
- Power consumption in standby operation: 1.5 W

### Dimensions

- Flush-mounted box, W x H x D: 528 x 312 x 65 mm
- Glass cover, W x H x D: 560 x 330 x 1.8 mm

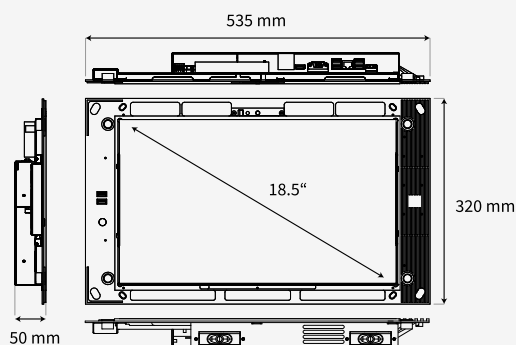

## Compatibility

### Visualizations

Any Windows or web-based, e.g.:

- Alexander Maier GmbH: EisBär SCADA
- BabTechnologie: CubeVison
- Gira: QuadClient, Ajax, X1
- Hager: Domovea
- Symcon GmbH: IP-Symcon
- Edomi, openHAB, ThinKnx and many more...

### Flush-mounted boxes

- Gira Control 19 & ServerClient 15

### Cameras

IP streams in RTSP, JPG and MJPG format, e. g. from:

- Hikvision
- Axis
- Mobotix and many more...

### Door communication

All SIP-enabled DCS, e.g.:

- Gira DCS incl. DCS-IP Gateway (in connection with Gira software)
- Doorbird IP Video Door station
- AGFEO IP-Video TFE
- Wantec Monolith C IP
- Mobotix T25 and many more...

### ETS

- ETS Inside Server

### Music software

Windows or web-based software:

- Apple iTunes, Spotify, Sonos and many more...

- Touch panel with high-quality finishing and built-in industrial components
- Reliable, noiseless operation
- YOUVI Basic software package for KNX bus control included, consisting of visualization, IP router and bus monitor
- KNX connection and software spare an external server
- Compatible with many other visualizations, SIP door stations and flush-mounted boxes
- Smooth display of surveillance cameras and other multimedia applications
- Exchangeable glass covers with individual designs