

Product Handbook

IO16F01KNX	Universal DIN Actuator 16 Inputs /16 Output Plus
IO16F01KNX- SD	Universal DIN Actuator 16 Inputs /16 Output Plus with SD-CARD
BO16F01KNX	Universal DIN Actuator 16 Output Plus
BO16F01KNX-SD	Universal DIN Actuator 16 Output Plus with SD-CARD

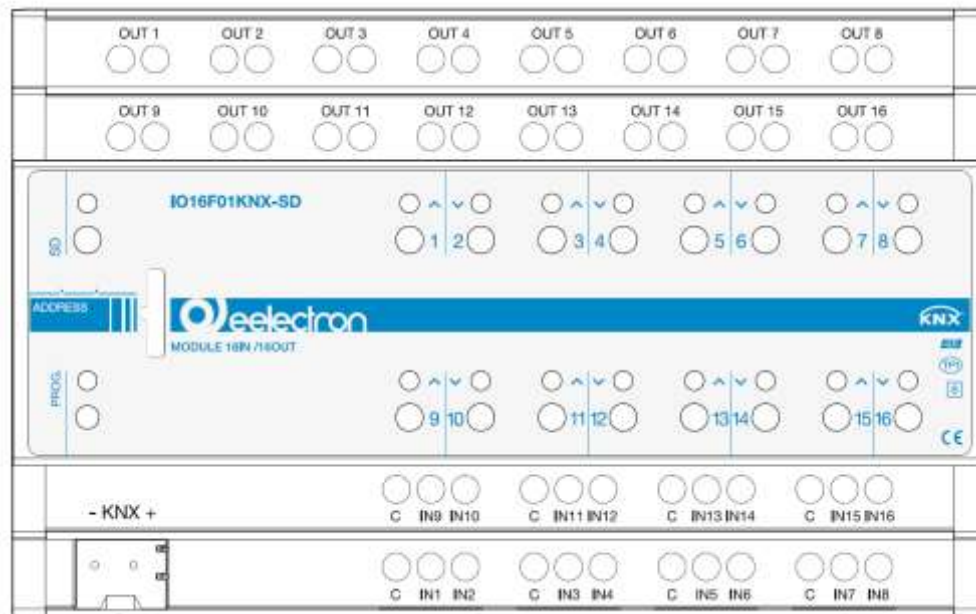

Document

Version: 1.1

Data:

20/07/2018

INDEX

1.	General introduction.....	5
2.	Product overview.....	5
3.	Installation instructions.....	6
4.	SD CARD.....	6
5.	General parameters.....	7
6.	Outputs.....	8
	Functional blocks description.....	8
	Functional blocks scheme.....	8
7.	Block A - 1 Relay.....	9
	Single relay - general parameters.....	9
	Single relay - on/off with timing-delay.....	9
	Single relay - continuous switching.....	11
	Single Relay - scenes.....	11
	Single relay - dynamic scenes.....	11
	Single relay - additional functions.....	12
	Single relay - logic.....	12
	Single relay - lock function.....	13
	Electric valve - general parameters.....	14
	Electric valve - lock function.....	14
8.	Block B - 2 Relays.....	15
	Shutters - general parameters.....	15
	Shutters - louveres parameters.....	16
	Shutters - alarms.....	16
	Shutters - automatic movements.....	17
	Shutters - scenes.....	17
	Shutters - dynamic scenes.....	18
	Shutters - Lock.....	18
	Servomotors - general parameters.....	18
9.	Block C - 3 Relays.....	19
	Shutter 3 contacts - general parameters.....	19
10.	Fan coil management.....	20
11.	Relays with interlock.....	22
12.	Global Objects.....	23
13.	Inputs.....	23
14.	Digital input.....	24
	Activation on press.....	24
	Activation on press / release.....	25
	Activation on short and long press.....	25
	Dimming.....	25
	Shutter and Blinds.....	26
	Scene.....	26
	Commands sequences.....	26
	Set RGB color.....	27
	MUR / DND.....	27
	Loop among values.....	27

15.	Led output.....	28
16.	Additional probe.....	28
	Additional probe - description.....	28
	Additional probe - parameters	28
17.	Temperature sensor.....	29
18.	Thermostat Function.....	29
	Target Setpoint Settings.....	29
	SETPOINT Object.....	29
	HVAC MODE obj. (switched heat / cool)	29
	HVAC MODE obj. (automatic heat / cool)	30
	SETPOINT COMFORT, STANDBY, ECONOMY.....	30
	COMFORT Object.....	30
	WINDOW CONTACT Object	30
	SETPOINT ADJUSTMENT object	31
	KNX probe temperature obj.	31
	ACTUAL SETPOINT object.....	31
	Two points on/off.....	31
	Integral proportional control PWM.....	32
	Integral proportional contr. continuous.....	32
	Fan coil on/off.....	32
	Fan coil control PI.....	34
	Additional valve	34
	Additional valve 6 ways.....	34
	Force fan coil speed.....	35
	Ventilation mode.....	35
	Temperature probe failure / out of range measurement.....	35
	Temperature alarm object	35
19.	Thermostat behaviour on bus failure, recovery and download.....	36
	Behaviour on bus voltage failure	36
	Behaviour on bus voltage recovery	36
	Behaviour on ETS Download	36
20.	Wrong application download.....	36

Any information inside this manual can be changed without advice.

This handbook can be download freely from the website: www.eelectron.com

Exclusion of liability:

Despite checking that the contents of this document match the hardware and software, deviations cannot be completely excluded. We therefore cannot accept any liability for this.

Any necessary corrections will be incorporated into newer versions of this manual.

Symbol for relevant information



Symbol for warning



DISPOSAL : The crossed-out bin symbol on the equipment or packaging means the product must not be included with other general waste at the end of its working life. The user must take the worn product to a sorted waste centre, or return it to the retailer when purchasing a new one. An efficient sorted waste collection for the environmentally friendly disposal of the used device, or its subsequent recycling, helps avoid the potential negative effects on the environment and people's health, and encourages the re-use and/or recycling of the construction materials

1. General introduction

This manual is intended for use by KNX® installers and describes functions and parameters of DIN modules IO16F01KNX and BO16F01KNX and how you can change settings and configurations using the ETS software tool.

The IO16F01KNX and BO16F01KNX devices are EIB / KNX DIN rail actuators with 16 16A-230V AC relay outputs; the IO16F01KNX device also includes 16 inputs for dry (potential-free) contacts. This manual refers to the IO16F01KNX module; all the features and functions described here are also applicable to the BO16F01KNX module with the exception of those relating to the inputs that are not present on the BO16F01KNX.

2. Product overview

IO16F01KNX is designed to be installed in Home and Building installations (i.e. offices, hotels, private houses, etc...).

Main functions of outputs

The outputs can be configured as:

- 16 outputs for light / load control
- 16 channels for valve in PWM (solenoid actuators)
- 8 channels for roller shutter / venetian control
- 8 channels for 3-point valve control
- 4 fan coil actuators 2-pipes

It is also possible to combine 2 or 3 relays with logic interlock for 4-pipe / 3-speeds fan coil control or combine groups of relays (up to 8) for special function using logic interlock. The device includes manual buttons for switching local relays and LEDs to indicate operation.

Main functions of inputs

The inputs (only on IO16F01KNX) can be connected to pushbuttons, switches, or be configured as outputs to activate individual signaling LEDs (see

LED eelectron code LD00A01ACC / LD00A11ACC) and can be used for:

- 1-bit commands: loads activation / deactivation commands (ON / OFF / TOGGLE) with short pressure or with long and short pressure differentiation
- 1 byte commands (0-255 or HVAC commands or % value commands).
- Sending long action telegrams to the same short action address or to a different group address
- Commands for cyclic sending
- Sequences (3 commands that mix 1 bit / 1 byte objects) with different group addresses - in short and long press mode or in switching mode
- Dimmer management (with single button or with double button)
- Roller shutters and blinds management (with single button or with double button)
- Control sequences with 1 bit to manage switching on / off lights or rows of lights
- RGB color setting with fixed value (short pressure) or color change (long pressure); 1 byte datapoint or 3 byte selectable
- MUR / DND (Make Up Room - / Do Not Disturb), function with built-in logics
- Loop function between values to send step by step a sequence of values of 1 byte

Furthermore, 4 inputs (out of the 16 available) can be configured as analogue for the connection of NTC temperature probes in order to send 4 temperature measurements on the bus and manage a simple on / off control (e.g. towel-heater). It is also possible to enable 2 complete thermostat modules if inputs 3 ÷ 8 and 11 ÷ 16 are not used; each thermostat module manages 2 stages with integrated PI controller for driving heating and cooling equipment, valves, 2 and 4 pipe fan coils, etc ..

NTC probes :

For NTC temperature probe the following eelectron code accessories must be used:



TS01A01ACC (from -20°C to +100°C)

TS01B01ACC (from -50°C to +60°C)

NTC probes main functions:

Configured as temperature sensors (4 sensors) - main functions:

- 2 different temperature thresholds to activate alarms / warnings with 1 bit telegrams
- Enable / disable alarms / alerts via 1-bit objects

Configured as thermostats (2 thermostats) - main functions:

- Different Control Algorithms: 2-point on / off; PWM; continuous control / Fan Coil control
- Different modes of operation mode setting: Automatic HVAC / HVAC Manual / Setpoint
- Additional command for 2nd stage management
- Window contact management
- Additional external probe (optional)

3. Installation instructions

The device can be used for permanent internal installations in dry places and is intended for DIN rail mounting in LV distribution cabinets.



WARNING

- Device must be installed at a minimum distance of 4 mm between electrical power line (mains) and input cables or red / black bus cable.
- The device must not be connected to 230V cables
- The device must be mounted and commissioned by an authorized installer.
- The applicable safety and accident prevention regulations must be observed
- The device must not be opened. Any faulty devices should be returned to manufacturer
- For planning and construction of electric installations, the relevant guidelines, regulations and standards of the respective country are to be considered.
- KNX bus allows you to remotely send commands to the system actuators. Do not lead to hazardous situations, and that the user always has a warning about which commands can be activated remotely.

- Relays are always switched on before delivering but, it is possible they get closed during transportation. It is recommended, when device is installed. To connect and supply the bus before the load voltage to ensure the opening of the contacts.
- Before programming the device using ETS, the output channels are configured for shutter management in order to avoid improper control of this type of load. The frontal button is configured to switch the relay with logical interlock.

For further information please visit:
www.eelectron.com

4. SD CARD

The devices whose code is marked by the extension SD (BO16F01KNX-SD e IO16F01KNX-SD) include a microSD card reader with which you can save the programming of the device to be able to restore it on an identical device in order to avoid programming in field or to allow a fast restore in case of failure. To manage the SD card, a button and a led are present on the device.

SAVING CONFIGURATION ON microSD CARD

During operation, device saves the configuration at each change (ETS download) if the card is present and recognized.

IDENTIFICATION OF microSD CARD AND FIRST SAVING

With the device disconnected from the bus, insert the microSD card and press the button; connect the bus, when the LED is on steady, keep pressing the button for at least 5 seconds to start copying the configuration on the microSD card. During the copy the led will flash quickly, at the end, if procedure ends successfully, the LED will remain on steady. Any previously saved data will be overwritten.

RESTORE CONFIGURATION FROM MicroSD CARD

With the led on steady, press the button for a long time (> 5 seconds) to start the restore; during

operation led will flash quickly, then it return to the on steady state to signal that the restore was successful.

LED SIGNALS

- Led off: microSD CARD not present
- Led on steady: microSD CARD ok – backup executed after ETS download
- 2 flashes every 2 seconds: reading or writing of microSD CARD failed
- 3 flashes every 2 seconds: microSD CARD not initialized
- 4 flashes every 2 seconds: microSD CARD belongs to another device model

Led	Description
Led OFF	microSD CARD not present
Led ON steady	microSD CARD ok - backup executed after ETS download
2 flashes every 2 s	reading or writing of microSD CARD failed
3 flashes every 2 s	microSD CARD not initialized
4 flashes every 2 s	microSD CARD belongs to another device model

 Once the configuration of the system is finished, it is suggested to remove the microSD card from the device, mark it with the physical address and keep it in a safe place in order to use it in case of replacement of the device to reprogram the new one,

 The microSD card must be inserted into the device before any update or modification with ETS to save the new downloaded configuration.

delay avoids to generate excessive traffic on the bus, causing slow performance or a transmission block. If there are different devices requiring sending telegrams on the bus after a reset, these delays must be programmed to prevent traffic congestion during the initialization phase. The input detection and the values of objects are updated at the end of the transmission delay time. At the end of ETS programming the device behaves like after a power on.

Local buttons	disabled/enabled
---------------	------------------

If this parameter is enabled, it is possible to activate the local relays by pressing the corresponding keys according to the configuration of the relays (single, shutters, fan coils, etc).

 The following parameters impact the consumption of the device on the bus. The highest consumption is found at power on (bus power on) and after relay switching; it is suggested to set a configuration that reduces the peak absorptions by limiting the high consumption to only devices on which it is strictly necessary to have simultaneous switching or to have immediate operation at power-up.

Permitted simultaneous relay commutation	1 .. 16
--	---------

Defines the maximum number of relays that can be switched simultaneously.

Maximum BUS current consumption after relay commutation	10mA .. 30mA
---	--------------

Defines the maximum current consumption from bus allowed for the device at power up or after relay switching; consider this parameter in designing the KNX lines.

Economy mode: switch off leds after inactivity	Never switch OFF; 1 .. 15 min.
--	-----------------------------------

It defines the behavior of the front leds, it is possible to set them to turn off after a few minutes when no manual action is performed on the local buttons.

5. General parameters

KNX PARAMETER	SETTINGS
Delay on Power up	3 ÷ 15 seconds
Through this parameter is possible to set the delay of transmission of telegrams after a power on by selecting the time by which the device is allowed to send telegrams. In large systems after a power failure or shutdown this	

6. Outputs

Outputs are divided into 2 groups, from 1 to 8 positioned on the lower level of the device and from 9 to 16 on the upper level.

Each 8-relay block can be set to manage 22 possible combinations by defining *Functional Blocks*.

Functional blocks description

Relays can be used individually or in combination with other relays to obtain more functions, the blocks are called A - B - C - D - E - F - G - H, each block can perform one of the following functions>

Block	Relays #	Description
A	1	Single Relay
		Electric valve
B	2	Shutter / Venetian
		Servomotor
		Fancoil 1 speed 1 valve (2 pipes)
		Interlock 2 relays
C	3	Fancoil 2 speeds 1 valve (2 pipes)
		Fancoil 1 speed 2 valves (4 pipes)
		Shutter with 3 contacts/limit switch
		Interlock 3 relays
D	4	Fancoil 3 speeds 1 valves (2 pipes)
		Fancoil 2 speeds 2 valves (4 pipes)
		Interlock 4 uscite
E	5	Fancoil 2 speeds 2 valves (4 pipes)
		Interlock 5 relays
F	6	Interlock 6 relays
G	7	Interlock 7 relays
H	8	Interlock 8 relays

Functional blocks scheme

RELAYS 1 ÷ 8 FUNCTIONAL BLOCKS								
	OUT 1	OUT 2	OUT 3	OUT 4	OUT 5	OUT 6	OUT 7	OUT 8
1	A1	A2	A3	A4	A5	A6	A7	A8
2	B1		A3	A4	A5	A6	A7	A8
3	B1		B2		A5	A6	A7	A8
4	B1		B2		B3		A7	A8
5	B1		B2		B3		B4	
6	D1				A5	A6	A7	A8
7	D1				B3		A7	A8
8	D1				B3		B4	
9	D1				D2			
10	E1					A6	A7	A8
11	E1					A6	B4	
12	E1					C4		
13	C1		A4	A5	A6	A7	A8	
14	C1		A4	A5	A6	B4		
15	C1		A4	B3		B4		
16	C1		C2			A7	A8	
17	C1		C2			B4		
18	D1				C3			A8
19	F1						A7	A8
20	F1						B4	
21	G1							A8
22	H1							

RELAYS 9 ÷ 16 FUNCTIONAL BLOCKS								
	OUT 9	OUT 10	OUT 11	OUT 12	OUT 13	OUT 14	OUT 15	OUT 16
1	A9	A10	A11	A12	A13	A14	A15	A16
2	B5		A11	A12	A13	A14	A15	A16
3	B5		B6		A13	A14	A15	A16
4	B5		B6		B7		A15	A16
5	B5		B6		B7		B8	
6	D3				A13	A14	A15	A16
7	D3				B7		A15	A16
8	D3				B7		B8	
9	D3				D4			
10	E2					A14	A15	A16
11	E2					A14	B8	
12	E2					C8		
13	C5			A12	A13	A14	A15	A16
14	C5			A12	A13	A14	B8	
15	C5			A12	B7		B8	
16	C5			C6			A15	A16
17	C5			C6			B8	
18	D3				C7			A16
19	F2						A15	A16
20	F2						B8	
21	G2							A16
22	H2							

7. Block A - 1 Relay

Block A identifies the functions related to 1 relays which are:

- Single relay (generic load)
- Electric valve

Single relay - general parameters

KNX PARAMETER	SETTINGS
Relay type, normally closed or open	Normally open Normally close
With this parameter it is possible to set the operating mode of the relay. The relay can be used as "open contact" or "closed contact"; this distinction is only logical because the relay has only one pole and a terminal connected to the NC contact is not available.	

Command (relay status)	Normally open	Normally closed
ON (activated)	contact closed	contact open
OFF (deactivated)	contact open	contact closed

KNX PARAMETER	SETTINGS
Command activation telegram	Activate with ON Activate with OFF
Determines whether the function is activated with a telegram "1" (i.e. off = "0") or is activated with telegram "0" (i.e. off = "1")	
Relay state at power on	No Action Go ON
Relay state at power off	GO OFF
Set this parameter to determine the status that the relay must take when the bus voltage drops and when it is restored	
Feedback enable/disable	Disabled Always On variation
Disabled: the relay status is never sent Always: status is transmitted each time the relay receives an actuation command On variation: the relay status is only transmitted when its status changes	
Counter Type	Nothing Instant Power Count energy Count ON or OFF time Count ON/OFF Toggles

The device allows to send on the bus one of the following counters:

Instant Power:

instantaneous power absorbed (presumed); it is not possible to measure the absorbed power but it is possible to send the presumed value (in Wh or KWh) based on the ETS parameter set as energy consumed in Watt or Kilowatt.

Count energy:

Energy consumed (presumed); it is not possible to measure the energy consumed but it is possible to send the presumed value based on the ETS parameter set as energy consumed in Watt or Kilowatt.

Count ON or OFF time:

counts the ON or OFF time of the relay in hours [2 bytes - dpt 7.007 time (h)]

Count ON/OFF Toggles:

counts the number of relay commutations [4 bytes - dpt 12.001 counter pulses]

Timing function type	No timing function On/off with timing and delay Continuous switching
No timing function: no timed function On/off with timing and delay: this parameter enables an object dedicated to managing the timed output [<Output Ax xx> Timing] with which to set a delay on activation, deactivation or the staircase lighting function. Continuous switching: function that switches the relay ON / OFF continuously	

Single relay - on/off with timing-delay

On the ETS page [<Output Axx | xx> Timing] the following parameters are visible.

KNX PARAMETER	SETTINGS
Timing unit measure	seconds / minutes / hours
Sets the unit of measure for the following timing parameters.	
Switch ON delay (0=no switch ON delay)	0..255
Sets the delay between receiving the ON command and activating the corresponding output (if set to 0 there will be no delays and execution will be immediate)	
ON state retention time (0=never switch OFF)	0..255
Sets the automatic switch-off time (staircase lights); if set = 0 it must be turned off by an OFF command	

Behaviour when receiving deactivation telegram during timing	Ignore command Go to retention end (switch off) Go to off state after time
Ignore command: the OFF command is ignored Go to retention end (switch off): the OFF command is executed immediately. Go to off state after time: The off command is executed after the time defined by the Switch OFF delay parameter	
Switch OFF delay, 0 = switch OFF immediately	0..255
Sets the delay between receiving the OFF command and activating the corresponding output (if set to 0 there will be no delays and execution will be immediate)	

Example 1:	
Set the staircase light to automatically switch off after 5 minutes without the possibility of manual switch-off	
PARAMETER	VALUE
Timing unit measure	Minuti
Switch ON delay	0
ON state retention time	5
Behaviour when receiving deactivation telegram during timing	Ignore command

Example 2:	
Set the automatic staircase light off after 50 seconds with the possibility of manual switch-off	
PARAMETER	VALUE
Timing unit measure	seconds
Switch ON delay	0
ON state retention time	50
Behaviour when receiving deactivation telegram during timing	Go to retention end (switch off):
Switch OFF delay	

Example 3:	
Set light ON with 5 seconds delay and OFF with 60 seconds delay	
PARAMETER	VALUE
Timing unit measure	seconds
Switch ON delay	5
ON state retention time	0
Behaviour when receiving deactivation telegram during timing	Go to off state after time
Switch OFF delay	60

KNX PARAMETER	SETTINGS
Behaviour when receiving telegram during timing	Ignore Restart ON state retention timer Extend time
Sets the behavior of the device when ON command is received while the timing is running: Ignore: the reception of an ON command is ignored and the timing continues. Restart ON state retention timer: when an ON command is received, the device restarts the timing Extend time: Upon receiving an ON command, the device extends the timing	
Warning signal before switch OFF	Do not signal 15 seconds 30 seconds 1 minutes 2 minutes 5% of retention time 10% of retention time 15% of retention time
Set the warning time before the end of the timed function; the device signals the imminent end of the timing with a short power off. Do not signal No warning signal is executed 15 s / 30 s / 1 min / 2 min Indicates how much time before the end of the timing the warning signal is executed 5% / 10% / 15% of retention time Indicates how much time before the end of the timing (in percentage) takes place the prevision (if the timing is 60 seconds setting 10% of retention time the warning takes place 6 seconds before the end.	
Command during timing behaviour	Actuate command and reset timing function Ignore command
Determines the behavior in case of receiving an ON or OFF command during the timing execution. Actuate command and reset timing: It executes the command received and cancels the timing in progress. Ignore command: Ignore the command received.	

Single relay - continuous switching

On the ETS page [<Output Axx | xx> Timing] the following parameters are visible.

KNX PARAMETER	SETTINGS
Timing unit measure	seconds / minutes / hours
Sets the unit measure for the following timing parameters.	
Continuous switching ON time	1..255
Relay ON time during continuous switching	
Continuous switching OFF time	1..255
Relay OFF time during continuous switching	

Single Relay - scenes

Enabling the scenario management, it is possible to associate up to 12 KNX scenarios and up to 64 dynamic scenarios to each output (see: Single relay - dynamic scenesSingle relay -)

You can send 2 commands to the scene object:

Recall scene: it is a command used to start execution of a scenario

Save scene: it is a command used to save the current status of the relays (when the command is received), this status is restored when the "Recall scene" telegram is received.

KNX PARAMETER	SETTINGS
Scene sources	Do not use scene objects Enable local scene objects Enable global scene objects Enable global and local scene objects
Do not use scene objects: scenes are disabled for this output Enable local scene objects for this output the scenes are enabled and are recalled by CO <Output Axx xx> Scenes Enable global scene objects for this output the scenes are enabled and are called via global CO <Global All> Scene (see par: Errore. L'origine riferimento non è stata trovata.) Enable global and local scene objects: for this output the scenes are enabled both with local CO and with global CO.	

The <Output Ax> Scene page will show the following parameters:

KNX PARAMETER	SETTINGS
Enable scene learning	disabled/enabled
If disabled, the output can not execute "Save Scenario" commands	
Enable dynamic scene learning	disabled/enabled
See par: Single relay - dynamic scenes	
Keep or override scene values after download	override/keep
Determines whether the scenarios saved with the "save scene" commands are restored at the value defined in the ETS or not when a download is performed.	
Scene counter	1..12
Defines how many KNX scenarios are associated with the output	
Scene x index	1..64
Defines which index is associated with the x scenario	
Scene x value	OFF/ON
Defines whether the status associated with the x scenario is ON or OFF after the first download, for subsequent downloads check how the "Keep or override scenes values after download" parameter is set	

Single relay - dynamic scenes

DESCRIPTION

The dynamic scene function is compatible with the standard KNX scenario and the actuators can use both at the same time.

The dynamic scene function uses the same 1 byte communication object (DPT 18.001) of the standard KNX scenario while maintaining the same structure and meaning.

To activate the dynamic scene function, the "Global Dynamic Scene" parameter on the "Global Objects" page must be set as "enabled", in this way the "<Global All> Dyn Scene" object is visible. This 1-bit communication object, one for each actuator, is used to enable / disable runtime the saving of the dynamic scenario value according to the value received on the <Output Axx | xx> Scenes.

HOW IT WORKS

When the object value "" <Global All> Dyn Scene "is 0 the dynamic scene function is disabled, it is possible to learn and execute the standard KNX scenarios as set by the ETS parameter.

When the value of the object "" <Global All> Dyn Scene "is 1, the dynamic scene function is enabled, during this condition any command sent to the relay is executed and also saved in memory. When a learning command is sent on the object 1 byte "<Output Axx | xx> Scene" the device saves the new status in memory and associates it with the number of the scenario just received.

If a learning command is sent to the 1 byte object "<Output Axx | xx> Scenes "without having previously updated the output status, the actuators consider this as a command to "disconnect" this output to the scenario number "n" and from this moment onwards, after receiving a recall scenario for the number of scenario "n" output does not react.

In this way it is possible to associate up to 64 scene numbers on each actuator output channel.

When the object "" <Global All> Dyn Scene "returns to 0, the learning of the dynamic scenario is completed.

The scenario call operation works in the same way as the standard KNX scenario.

Single relay - additional functions

Possono essere abilitate 2 funzioni addizionali:

KNX PARAMETER	SETTINGS
Additional object type	Do not use Use for logic function Use for locking function

LOGIC FUNCTION

This function allows to control the load, through the result of a logic operation, the logic function consists of two logical inputs: the operation is performed between the logic input and the relay command object.

LOCK AND LOGIC are alternative functions, they can not be activated at the same time.

LOCK FUNCTION

Locks the relay in a specific position, this state is maintained until is received a specific command to exit the block status; any command received during the period in which the lock mode is active is not executed.

Single relay - logic

When the logic operation is enabled, the output command is the result of a logical operation between the communication object "<Output Axx | xx> Logic "and the object" "<Output Axx | xx> Command ".

Using ETS, you can select the logical operation: whenever a telegram is received on the logical object or command object, the logic operation is recalculated and the result is interpreted as a command for the relay.

KNX PARAMETER	SETTINGS
Logic function for command and additional	AND NAND OR NOR XOR XNOR
This allows you to select which logical operator to use.	
Additional command logic value after download	Start in ON state Start in OFF state
This parameter allows to select the initial value of the logical operator. By setting "Last received value" the last value before switching off is considered valid.	
Delay logic output (seconds)	0..7
This parameter inserts a delay between the recalculation of the resulting logic function (which occurs after the objects "<Output Axx xx> Logic" or the object "" <Output Axx xx> Command) have been updated and the relay status update. The insertion of a delay allows to "filter" too frequent updates on the status of the outputs due to the recalculation of the resulting logic. The delay is in seconds.	
Global command object	<ul style="list-style-type: none"> Do not use global command object Use global command object as command Use global command object as logic

This parameter refers to the management of global objects (see par: Global Objects) .

Do not use global command object

The result of the logic function is calculated without taking into account the values received on the global object



Use global command object as command

The global command is considered as a command that overlaps with the result of the logical operation.

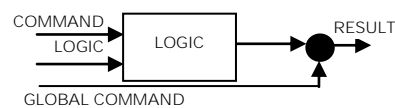

Use global command object as logic

The global command is put into logic with the result of the main logic, the 2 logical operators can be different.

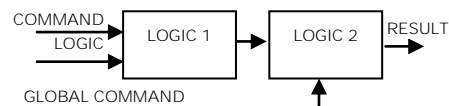

Single relay - lock function

When the lock function is enabled, it forces the relay to be switched into a defined state by a bus telegram and forces it to retain this status even if it receives bus commands on other switching objects.



When the lock function is active, the local keys, also if enabled, do not work.

Lock function is not used
 Enable local lock object
 The block function is activated / deactivated only via the <Output Axx | object xx> Lock
 Enable global lock obj
 The block function is only activated / deactivated via the object the <Global All> Lock object
 Enable local and global lock object
 The block function is activated / deactivated via the <Output Axx | object xx> Lock or the <Global All> Lock object

On the <Output Axx> Lock page, the following parameters are set

KNX PARAMETER	SETTINGS
Lock state after download	Locked / unlocked
Set the value of the block function after download	
Telegram for lock activation	Activate on OFF teleg. Activate on OFF teleg.
Defines which telegram is to lock and which one is to unlock.	
Automatic unlock after time (0 = never unlock automatically)	0..255
Lock can be set as a timed function, the lock function is deactivated at the end of the blocking time	
If the lock function is set with automatic deactivation, the timeout time is reloaded each time a new lock activation telegram is received.	
Output value when locked	Switch OFF / Switch ON
This parameter selects the state that the relay must assume when the "lock" function is activated.	
Output value when unlocked	Switch OFF Switch ON Switch to last value received Switch to last value before lock
Switch OFF Relay in OFF Switch ON Relay in ON. Switch to last value received The relay returns to the position corresponding to the last command received. Switch to last value before lock The relay returns to the position prior to activation of the lock.	

KNX PARAMETER	SETTINGS
Lock sources	Do not use lock object [1] Enable local lock object [1] Enable global lock obj. [2] Enable local and global lock object [2]
[1] : visible only if additional object set for logic [2] : visible only if additional object set for lock This parameter refers to the management of global objects. Do not use lock object	

Electric valve - general parameters

The single-relay configuration allows to manage also ON / OFF solenoid valves for heating / cooling systems. The open or closed relay condition must be correctly associated with the open or closed valve condition as some valves, when energized, are open while others are closed.

The control of this type of valves can be ON / OFF through the 1 bit object <Output Axx | xx> Open / Close or PWM type. The PWM control is used to avoid the temperature hysteresis typical of the ON / OFF control. The relay operates the valve with the ON / OFF commands but performs a proportional control (0% ÷ 100%) based on the value received on the object <Output Axx | xx> PWM% modulating the pulse widths ON and OFF over time.

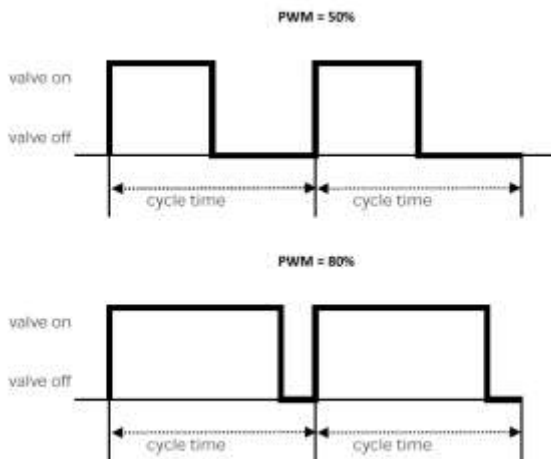

KNX PARAMETER	SETTINGS
Valve position when relay is close	open close
Defines the status of the valve when it's energized or not.	
Telegram for valve open	Telegram 0 Telegram 1
Defines the status of the valve when it is energized or not.	
Cycle base time for PWM [min]	5 .. 255
It defines the "cycle time" in which the actuator is activated at a time interval and then switched off again until the end of the cycle time.	
PWM lower limit value	0% ÷ 30%
Defines the minimum value received below which the valve is always closed.	
PWM upper limit value	70% ÷ 100%
Defines the maximum value received above which the valve is always open.	

Feedback state	disabled / enabled
Defines whether or not to send the status with a 1-bit object	
Feedback PWM%	disabled / enabled
Defines whether or not to send the status with a 1-byte object	
Anti lock function	disabled / enabled
It is possible to enable an automatic valve switching function, useful in case of long periods of inactivity, for example during the summer season. If this function is activated, it's possible to select how long the period of inactivity may last (refer to the "Anti-lock valve activation period" parameter); before the valve opens and after 5 minutes closes.	
Anti lock movement frequency	from 1 time per day up to 1 time every 16 days with granularity 1 day
Determines the maximum valve inactivity period before the anti-lock function is activated.	

Electric valve - lock function

When the lock function is enabled, the relay allows the relay to be switched to a defined state by means of a bus telegram and forcing it to retain this status even if it receives bus commands on other switching objects.



When the lock function is active, local buttons are not working.

KNX PARAMETER	SETTINGS
Lock sources	Do not use lock object Enable local lock object Enable global lock obj. Enable local and global lock object
This parameter refers to the management of global objects. Do not use lock object Lock function is not used Enable local lock object The block function is activated / deactivated only via the <Output Axx object xx> Lock Enable global lock obj The block function is only activated / deactivated via the object the <Global All> Lock object Enable local and global lock object The block function is activated / deactivated via the <Output Axx object xx> Lock or the <Global All> Lock object	

The specific parameters of the block function are the same ones seen for the management of the single relay

8. Block B - 2 Relays

Block B identifies the functions linked to 2 coupled relays which are:

- Shutters / Venetian blinds
- Servomotors
- Interlock 2 relays (see par. Relays with interlock)
- Fancoil 1 speed 2 pipes (1 valve) see par. *Fancoil*)

Shutters - general parameters

The outputs can be configured as "combined" to control rolling shutters or blinds

Block B 2 Relays - Shutters with 2 switch limits				
B1	OUT1/2	OUT1	▲ (UP)	OUT2 ▼(DOWN)
B2	OUT3/4	OUT3	▲ (UP)	OUT4 ▼(DOWN)
B3	OUT5/6	OUT5	▲ (UP)	OUT6 ▼(DOWN)
B4	OUT7/8	OUT7	▲ (UP)	OUT8 ▼(DOWN)
B5	OUT9/10	OUT9	▲ (UP)	OUT10 ▼(DOWN)
B6	OUT11/12	OUT11	▲ (UP)	OUT12 ▼(DOWN)
B7	OUT13/14	OUT13	▲ (UP)	OUT14 ▼(DOWN)
B8	OUT15/16	OUT15	▲ (UP)	OUT16 ▼(DOWN)

KNX PARAMETER	SETTINGS
Shutter type	Shutter / Venetian
Select "Venetian blind" if the shutter has slats; otherwise select shutter.	
<i>Shutter travel time [s]</i>	0 ÷ 3000
This parameter sets the total travel time of the shutter	
Extra time for shutter travel up [s]	5 ÷ 30
Questo parametro indica il numero di secondi da aggiungere al tempo di corsa per tutti i movimenti che portano la tapparella verso l'alto.	
Extra time for shutter travel down [s]	5 ÷ 30
This parameter indicates the number of seconds to add to the travel time for all the movements that bring the shutter upwards.	
Stop time between 2 same shutter movements	from 100 ms to 5 seconds

Defines the minimum stop time between 2 movements of the shutter in the same direction.	
Stop time between 2 opposite shutter movements	from 100 ms to 5 seconds
Defines the minimum stop time between 2 shutter movements in opposite directions.	
Up/down sources	Do not use up / down object Enable local up / down object Enable global up / down object Enable local and global up / down object
This parameter refers to the handling of the 1-bit up / down object and global objects (see par. 12) Do not use up/down object The up / down object is not used Enable local up/down object The up / down object is only local: <Output Bx xx> Up / Down Enable global up/down obj The up / down object is only global: <Global Shutter> Up / Down Enable local and global up/down object The up / down object is both local and global.	
Delay global up/down [s]	0 ÷ 15
This parameter, visible only if the global object is enabled, allows to insert a delay to the activation of the movement, this delay is generally used to avoid activating many shutters at the same time in case of automatic commands at pre-established times.	
Shutter % sources	Do not use shutter object Enable local shutter object Enable global shutter object Enable local and global shutter object
This parameter refers to the management of the 1 byte position % object and global objects	
Louvre % sources	Do not use louvre object Enable local louvre object Enable global louvre obj Enable local and global louvre object
This parameter refers to the management of the 1 byte louveres % object	
Feedback up/down	disabilita / abilita
Enable the 1 bit object <Output Bx xx> up / down status that sends on the bus the direction of the last movement	
Feedback shutter pos. %	disabled / enabled

Enable the 1-byte object <Output Bx xx> shutter status that sends on the bus the position of the shutter	
Feedback louvre position %	disabled / enabled
Enable the 1-byte object <Output Bx xx> louvre status that sends on the bus the position of the louvres	
Feedback rising / lowering	disabled / enabled
Enable the 1-bit objects <Output Bx xx> Rising Status and <Output Bx xx> lowering status that sends on the bus the indication if the shutter is in up / down movement respectively (1) or is stopped (0).	

Shutters - louvres parameters

If block B is configured as a blind, it is possible to manage the position % of the louvres.

KNX PARAMETER	SETTINGS
Louvre time for full revolution [0.1 s)	10 ÷ 255
Time for the complete rotation of the slats, ie time necessary for the slats to pass from totally open to totally closed. Value expressed in tenths of a second, enter 30 for 3 seconds, 40 for 4 seconds and so on.	
Number of steps for complete louvre rotation	2 ÷ 10
Indicate in how many steps you want to make a complete rotation of the lamellae.	
Louvre movement after up	Nothing keep Fixed position
At the end of a rising movement it is possible to set that the slats do not move or return to the position before the movement or that they are brought to a fixed position%.	
Louvre movement after down	Nothing keep Fixed position
Like the previous parameter, after a downward movement.	

Shutters - alarms

The alarm function must be enabled if the shutter / blind is controlled by weather sensors, usually rain and wind.

When the alarm function is activated, the shutter performs a defined action and can not be moved unless the block function with the highest priority is activated.

KNX PARAMETER	SETTINGS
Activation telegram	telegram 0 / telegram 1
Defines which value of the 1-bit telegram activates the alarm function for this block.	
Supervision time for alarm [min] (0=never switch off alarm automatically)	0 ÷ 120 
This parameter selects the duration of the monitoring time for the alarm function. If this time is set to 30 min, the shutter must receive at least once in 30 min. a telegram from the sensor, even if the telegram indicates "No alarm". If this does not happen, the alarm will become active and a "No alarm" telegram will be required for the reset. For this reason, the sensor must be set to perform a cyclic sending and we recommend setting the supervision time greater than twice the cyclic sending period. The value 0 causes the shutter to not control the reception of the cyclic telegram.	

For the alarms, each shutter block has 3 global objects and 1 local object:

<Global Shutter> Alarm 1	Global object 1 - alarm
<Global Shutter> Alarm 2	Global object 2 - alarm
<Global Shutter> Alarm 3	Global object 3 - alarm
<Output Bx xx> Alarm	Local object - alarm

Global alarm objects have different priorities: Alarm 1 has higher priority than Alarm 2 and Alarm 3; Alarm 2 has higher priority than Alarm 3; so if two alarms are active at the same time, the action associated with the one with the highest priority will be performed.

Local alarm can be configured by the ETS parameter as "Type 1" or "Type 2" or "Type 3", in this way it will be associated with the corresponding priority (1 maximum, 3 minimum).

KNX PARAMETER	SETTINGS
Global alarm 1	disabled / enabled
Global alarm 2	disabled / enabled
Global alarm 3	disabled / enabled
Enables block B to be subordinated to the corresponding global alarm object and shows the related setting parameters.	
Local alarm type	None Type 1 Type 2 Type 3
If enabled local alarm is associated with the corresponding type (and priority).	
Shutter action on alarm x	Stop - no movement

activation	Move up Move down
Defines the action for the shutter on alarm activation.	
Louvre action on alarm x activation	None Keep Fixed
Defines the action for the louvres on alarm activation.	
Shutter action on alarm x deactivation	none Move up Move down Last value received Last value before alarm
Defines the action for the shutter on alarm deactivation.	
Louvre action on alarm x deactivation	none Keep Fixed Last value received Last value before alarm
Defines the action for the louvres on alarm deactivation.	

Shutters - automatic movements

The automatic movements of the shutters are useful for managing situations connected to the presence / absence of people in the room (detected by presence sensors) or connected to the solar irradiation of the windows (an external brightness sensor is required). Actions in both cases may depend on the working mode of HVAC in the building: heating or cooling.

Enabling the Presence / Sun automatic movement parameter makes the <Output Bx> Auto Movement page available; and the following communication objects:

<Output Bx xx> Auto Movement	1 bit
<Output Bx xx> Presence / Sun	1 bit

From the Global Objects management page, you can instead enable the object

<Global All> Heat / Cool	1 bit
--------------------------	-------

<Output Bx | xx> Auto Movement: enable / disable the management of automatic movement; for example, if at night time a fixed position is required to the shutters, the automatism is disabled.

<Output Bx | xx> Presence / Sun: indicates to the shutter output block if there is a presence of people in the room (telegram 1) or absence (telegram 0).

If used for solar radiation management of building façades, it indicates whether the façade is irradiated (telegram 1) or unirradiated (telegram 0).

<Global All> Heat / Cool: this global object makes it possible to differentiate automatic actions based on the current season.

By closing the shutters in the summer when the façade of the building is irradiated by the sun, the rooms are prevented from overheating, saving energy in the air conditioning; in winter it is preferable, on the contrary, to let in the sun's rays to heat the rooms as much as possible.

Shutters - scenes

Enabling the scenario management, it is possible to assign up to 12 KNX scenarios and up to 64 dynamic scenarios to each shutter block

You can send 2 commands to the scene object:

Recall scene: it is a command used to start execution of a given scene

Save scene: it is a command used to save the current status of the relays (when the command is received), this status is reproduced when the "Recall scenario" telegram is received.

KNX PARAMETER	SETTINGS
Scene sources	Do not use scene objects Enable local scene objects Enable global scene objects Enable global and local scene objects
Do not use scene objects: the scenarios are disabled for this block Enable local scene objects for this block the scenarios are enabled and are recalled by CO <Output Bx xx> Scenes Enable global scene objects for this output the scenes are enabled and are recalled via global CO <Global All> Scene Enable global and local scene objects: for this output the scenes are enabled both with local CO and with global CO.	

The <Output Ax> Scene page will show the following parameters:

KNX PARAMETER	SETTINGS
Enable scene learning	disabled/enabled
If disabled, the outputs can not execute "Save Scenario" commands	
Enable dynamic scene learning	disabled/enabled
See "Shutters - dynamic scenes"	
Keep or override scene values after download	override/keep
Determines whether the scenarios saved with the "save scene" commands are shown at the value defined in the ETS or not at download.	
Scene counter	1..12
Defines how many KNX scenarios are associated with the output	
Scene x index	1..64
Defines which index associated with the x scenario	
Scene x value	OFF/ON
Defines whether the status associated with the x scenario is ON or OFF after the first download, for subsequent downloads check how the "Keep or override scenes values after download" parameter is set	

Shutters - dynamic scenes

DESCRIPTION

The dynamic scene function is compatible with the standard KNX scenario and the actuators can use both at the same time.

The dynamic scene function uses the same 1 byte communication object (DPT 18.001) of the standard KNX scenario while maintaining the same structure and meaning.

To activate the dynamic scene function, the "Global Dynamic Scene" parameter on the "Global Objects" page must be set as "enabled", in this way the "<Global All> Dyn Scene" object is visible. This 1-bit communication object, one for each actuator, is used to enable / disable runtime the saving of the dynamic scenario value according to the value received on the <Output Bx | xx> Scene.

HOW IT WORKS

When the object value "" <Global All> Dyn Scene "is 0 the dynamic scene function is disabled, it is possible to learn and execute the standard KNX scenarios as set by the ETS parameter.

When the value of the object " <Global All> Dyn Scene "is 1, the dynamic scene function is enabled, during this condition any command sent to the relay is executed and also saved in memory. When a learning command is sent on the object 1 byte "<Output Bx | xx> Scene" the device saves the new status in memory and associates it with the number of the scenario just received.

If a learning command is sent to the 1 byte object ""<Output Bx | xx> Scene" without having previously updated the output status, the actuators consider this as a command to "disconnect" this output to the scenario number "n" and from this moment onwards, after receiving a recall scenario for the number of scenario "n" output does not react.

In this way it is possible to associate up to 64 scene numbers on each actuator output channel.

When the object "" <Global All> Dyn Scene "returns to 0, the learning of the dynamic scene is completed.

The scenario call operation works in the same way as the standard KNX scene.

Shutters - Lock

In the case of shutters, the block function has the same behavior seen for single relays. The block function has the highest priority, even on alarms and as long as the shutter does not leave the blocking state no movement can be performed.

Servomotors - general parameters

The block includes the association of 2 relays for the management, in HVAC systems, of servomotors, 3-way valves or ventilation grilles.

The management of the 3-way valves is carried out using the coupled relays, in each pair of relays one

executes the OPENING action and the other the CLOSING.

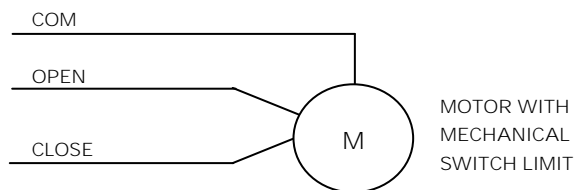

The parameters allow to set:

- The total opening / closing time
- The opening extra-time
- The CLOSing extra-time
- The minimum pause time between 2 movements
- The frequency of the anti-locking function
- The status sent on the bus

Through these 1 bit communication objects it is possible to set the position of the valve or of the servomotor

<Output Bx xx> Position 1	1 bit
<Output Bx xx> Position 2	1 bit
<Output Bx xx> Position 3	1 bit

come definito dai parametri:

KNX PARAMETER	SETTINGS
Position 1	0% ÷ 100% (default 30%)
Position 2	0% ÷ 100% (default 65%)
Position 3	0% ÷ 100% (default 100%)

9. Block C - 3 Relays

Block C identifies the functions related to 3 coupled relays that are:

- Shutter/Venetians with 3 contacts
- Interlock 3 relays (cfr. par. Relays with interlock)
- Fancoil 1 speed 4 pipes (2 valves) (cfr. par. *Fancoil*)
- Fancoil 2 speed 2 pipes (1 valve) (cfr. par. *Fancoil*)

Shutter 3 contacts - general parameters

The outputs can be configured as "combined in groups of 3" to control rolling shutters or blinds with 3 limit switches (3 contacts shutters), the wiring diagram for this type of shutters is the one shown in the figure below.

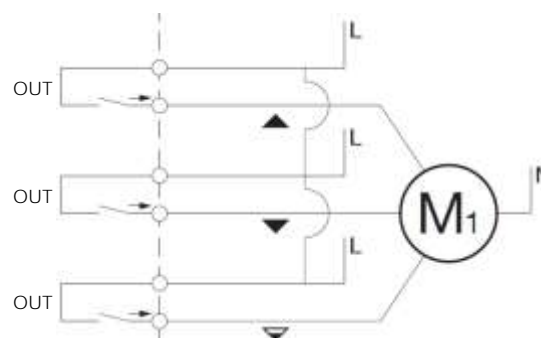

In addition to the outputs that activate the up [▲] and down [▼] circuits there's a third output used to manage the down 2 movement [▼] which allows the shutter to go beyond the limit switch established for the down movement, this close the louvers completely.

Block C - 3 Relays - shutters with 3 contacts					
C1	OUT 1/2/3	OUT1	▲ (UP)	OUT3	▼ (DOWN 2)
		OUT2	▼ (DOWN 1)		
C2	OUT 4/5/6	OUT4	▲ (UP)	OUT6	▼ (DOWN 2)
		OUT5	▼ (DOWN 1)		
C3	OUT 5/6/7	OUT5	▲ (UP)	OUT7	▼ (DOWN 2)
		OUT6	▼ (DOWN 1)		
C4	OUT 6/7/8	OUT6	▲ (UP)	OUT8	▼ (DOWN 2)
		OUT7	▼ (DOWN 1)		
C5	OUT 9/10/11	OUT9	▲ (UP)	OUT11	▼ (DOWN 2)
		OUT10	▼ (DOWN 1)		
C6	OUT 12/13/14	OUT12	▲ (UP)	OUT14	▼ (DOWN 2)
		OUT13	▼ (DOWN 1)		
C7	OUT 13/14/15	OUT13	▲ (UP)	OUT15	▼ (DOWN 2)
		OUT14	▼ (DOWN 1)		
C8	OUT 14/15/16	OUT14	▲ (UP)	OUT16	▼ (DOWN 2)
		OUT15	▼ (DOWN 1)		

TYPICAL LOUVRES CONFIGURATION ON 3 CONTACTS SHUTTER

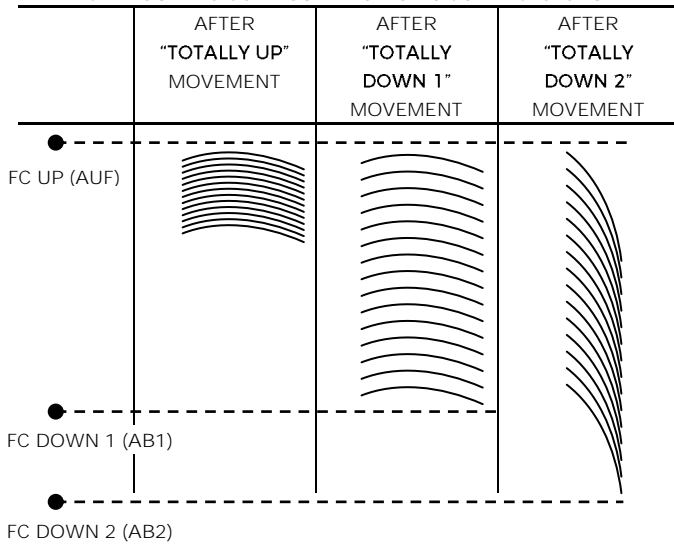

With these communication objects it is possible to set the shutter position with 3 limit switches

<Output Cx xx> Up/Down	Up/Down AUF-AB2
<Output Cx xx> Step/Stop	Step/stop AUF-AB2
<Output Cx xx> Up/Down AB1	Up/Down AUF-AB1
<Output Cx xx> Step/Stop AB1	Step/stop AUF-AB1



The position corresponding to 100% must be reached in correspondence with the second lower limit switch FC DOWN 2 (AB2) so the downward travel time inserted in ETS must correspond to a complete up to down travel: with <Output Cx | xx> Up / Down move the shutter all DOWN and then move it totally ON and count the travel time. This time must be set in ETS.



In the position corresponding to the first lower limit switch FC DOWN 1 (AB1) the position % of the shutter will be less than 100% because this value corresponds to the position of the second lower limit switch FC DOWN 2 (AB2)

The parameters of the 3 contacts shutters with 3 relays are identical to those of the 2 contacts shutters with 2 relays.

10. Fan coil management

The IO16F01KNX and BO16F01KNX devices allow the management of the following configurations for the fan coil:

Block	Relays	Valves (pipes)	Speeds
B	2	1 valve (2 pipes)	1 speeds
C	3	1 valve (2 pipes)	2 speeds
	3	2 valves (4 pipes)	1 speed
D	4	1 valve (2 pipes)	3 speeds
	4	2 valves (4 pipes)	2 speeds
E	5	2 valves (4 pipes)	3 speeds

Di seguito le configurazioni possibili:

Block B 2 Relays - 1 valve (2 pipes) / 1 speeds					
B1	OUT1/2	OUT1	VALVE	OUT2	SPEED 1
B2	OUT3/4	OUT3	VALVE	OUT4	SPEED 1
B3	OUT5/6	OUT5	VALVE	OUT6	SPEED 1
B4	OUT7/8	OUT7	VALVE	OUT8	SPEED 1
B5	OUT9/10	OUT9	VALVE	OUT10	SPEED 1
B6	OUT11/12	OUT11	VALVE	OUT12	SPEED 1
B7	OUT13/14	OUT13	VALVE	OUT14	SPEED 1
B8	OUT15/16	OUT15	VALVE	OUT16	SPEED 1

Block C - 3 Relays - 1 valve (2 pipes) / 2 speeds					
C1	OUT 1/2/3	OUT1	VALVE	OUT2	SPEED 1
				OUT3	SPEED 2
C2	OUT 4/5/6	OUT4	VALVE	OUT5	SPEED 1
				OUT6	SPEED 2
C3	OUT 5/6/7	OUT5	VALVE	OUT6	SPEED 1
				OUT7	SPEED 2
C4	OUT 6/7/8	OUT6	VALVE	OUT7	SPEED 1
				OUT8	SPEED 2
C5	OUT 9/10/11	OUT9	VALVE	OUT10	SPEED 1
				OUT11	SPEED 2
C6	OUT 12/13/14	OUT12	VALVE	OUT13	SPEED 1
				OUT14	SPEED 2
C7	OUT 13/14/15	OUT13	VALVE	OUT14	SPEED 1
				OUT15	SPEED 2
C8	OUT 14/15/16	OUT14	VALVE	OUT15	SPEED 1
				OUT16	SPEED 2

Block C - 3 Relays - 2 valvole (4 tubi) / 1 velocità					
C1	OUT 1/2/3	OUT1	WARM VALVE	OUT3	SPEED 1
		OUT2	COLD VALVE		
C2	OUT 4/5/6	OUT4	WARM VALVE	OUT6	SPEED 1
		OUT5	COLD VALVE		
C3	OUT 5/6/7	OUT5	WARM VALVE	OUT7	SPEED 1
		OUT6	COLD VALVE		
C4	OUT 6/7/8	OUT6	WARM VALVE	OUT8	SPEED 1
		OUT7	COLD VALVE		

C5	OUT 9/10/11	OUT9	WARM VALVE	OUT11	SPEED 1
		OUT10	COLD VALVE		
C6	OUT 12/13/14	OUT12	WARM VALVE	OUT14	VELOCITÀ 1
		OUT13	COLD VALVE		
C7	OUT 13/14/15	OUT13	WARM VALVE	OUT15	VELOCITÀ 1
		OUT14	COLD VALVE		
C8	OUT 14/15/16	OUT14	WARM VALVE	OUT16	VELOCITÀ 1
		OUT15	COLD VALVE		

Block D - 4 Relays - 2 valves (4 pipes) / 2 speeds					
D1	OUT 1/2/3/4	OUT1	WARM VALVE	OUT2	COLD VALVE
		OUT3	SPEED 1	OUT4	SPEED 2
D2	OUT 5/6/7/8	OUT5	WARM VALVE	OUT6	COLD VALVE
		OUT7	SPEED 1	OUT8	SPEED 2
D3	OUT 9/ 10/11/12	OUT9	WARM VALVE	OUT10	COLD VALVE
		OUT11	SPEED 1	OUT12	SPEED 2
D4	OUT 13/ 14/15/16	OUT13	WARM VALVE	OUT14	COLD VALVE
		OUT15	SPEED 1	OUT16	SPEED 2

Block D - 4 Relays - 1 valve (2 pipes) / 3 speeds					
D1	OUT 1/2/3/4	OUT1	VALVE	OUT2	SPEED 1
		OUT3	SPEED 2	OUT4	SPEED 3
D2	OUT 5/6/7/8	OUT5	VALVE	OUT6	SPEED 1
		OUT7	SPEED 2	OUT8	SPEED 3
D3	OUT 9/ 10/11/12	OUT9	VALVE	OUT10	SPEED 1
		OUT11	SPEED 2	OUT12	SPEED 3
D4	OUT 13/ 14/15/16	OUT13	VALVE	OUT14	SPEED 1
		OUT15	SPEED 2	OUT16	SPEED 3

Block E - 5 Relays - 2 valves (2 pipes) / 3 speeds					
E1	OUT 1/2 3/4/5	OUT1	WARM VALVE	OUT2	COLD VALVE
		OUT3	SPEED 1	OUT4	SPEED 2
		OUT5	SPEED 3	-	-
E2	OUT 9/10 11/12/13	OUT9	WARM VALVE	OUT10	COLD VALVE
		OUT11	SPEED 1	OUT12	SPEED 2
		OUT13	SPEED 3	-	-

Main parameters for fan coil management

KNX PARAMETER	SETTINGS
Relay state when valve is deactivated	Relay is open when valve is deactivated Relay is closed when valve is deactivated
Defines whether the relay must be open or closed to open / close the valve; the valve is deactivated when the fluid does not circulate.	
Global all valve closed	Not subordinate Subordinate

Defines whether the fan coil valves participate in the management of the global object <Global All> All valve closed.	
Delay between Speed Changes (Sec.)	1... 255
This parameter sets the pause time between switching off the relay that controls a speed and switching on another relay to activate another speed	
Delay on ventilation start (min)	1 ... 15
This parameter introduces a delay time between the reception of a command that opens the valve the activation of the ventilation speeds. Sometimes the hydraulic system needs some time before supplying the hot fluid to the fan coil; with this delay it is avoided to introduce cold air in the first few minutes after the start. The delay can be entered in heating mode or in cooling mode or in both modes and only when one of the speeds is activated starting from the status of no active speed (V1, V2 and V3 are all deactivated). To inform the actuator of the active heating or cooling status, use the global <Global All> Heat / Cool object	
Lower limit value	0% - 5% - 10%
Minimum value of control in the transition from speed 1 to OFF.	
Limit value speed 1/2	10% ÷ 40% resolution 5%
Control value in the transition from speed 1 to 2 and vice versa.	
Limit value speed 2/3	60% ÷ 90% risoluzione 5%
Control value in the transition from speed 2 to 3 and vice versa.	
Value to send - speed 1	0... 255
Value to send - speed 2	0... 255
Value to send - speed 3	0... 255
These 3 parameters indicate the value to be sent on the bus as a notification of the speed status. The value is in the range from 0 to 255 and must be displayed by the supervisor as a percentage value. Enter a value corresponding to the desired percentage value following the formula Value255 = Value 100 * 255/100. Example: if you want to send the value 10% for speed 1: value255 = 10 * 255/100 = 25	

Main parameters for managing interlock relays:

11. Relays with interlock

The INTERLOCK function allows to use a group of (consecutive) relays in interlocked mode, so that within each group only one relay can be activated at a time (or no relay). The interlock relay groups are usually used to interface other sub-systems (alarm, audio, entertainment, etc.) through the clean contact outputs of the relays.

Interlocking groups can be:

Block B - 2 Relays with interlock	
B1	OUT 1 / 2
B2	OUT 3 / 4
B3	OUT 5 / 6
B4	OUT 7 / 8
B5	OUT 9 / 10
B6	OUT 11 / 12
B7	OUT 13 / 14
B8	OUT 15 / 16

Block C - 3 Relays with interlock	
C1	OUT 1 / 2 / 3
C2	OUT 4 / 5 / 6
C3	OUT 5 / 6 / 7
C4	OUT 6 / 7 / 8
C5	OUT 9 / 10 / 11
C6	OUT 12 / 13 / 14
C7	OUT 13 / 14 / 15
B8	OUT 14 / 15 / 16

Block D - 4 Relays with interlock	
D1	OUT 1 / 2 / 3 / 4
D2	OUT 5 / 6 / 7 / 8
D3	OUT 9 / 10 / 11 / 12
D4	OUT 13 / 14 / 15 / 16

Block E - 5 Relays with interlock	
E1	OUT 1 / 2 / 3 / 4 / 5
E2	OUT 9 / 10 / 11 / 12 / 13

Block F - 6 Relays with interlock	
F1	OUT 1 / 2 / 3 / 4 / 5 / 6
F2	OUT 9 / 10 / 11 / 12 / 13 / 14

Block G - 7 Relays with interlock	
G1	OUT 1 / 2 / 3 / 4 / 5 / 6 / 7
G2	OUT 9 / 10 / 11 / 12 / 13 / 14 / 15

Block H - 8 Relays with interlock	
H1	OUT 1 / 2 / 3 / 4 / 5 / 6 / 7 / 8
H2	OUT 9 / 10 / 11 / 12 / 13 / 14 / 15 / 16

KNX PARAMETER	SETTINGS
Contact type	Normally open Normally close
The parameter is unique for the whole interlock relay group, if you choose "Normally closed" all the relays of the group will be closed except for the one that is activated that can remain open. If you choose "Normally open" all the relays of the group will be open except for the one that is activated that can remain closed.	
Contact delay	1 ÷ 16 seconds
It defines the time of inhibition between the deactivation of a relay and the activation of another relay.	
Interlock activation telegram	Telegram 0 Telegram 1
Defines the value of the 1-bit relay activation telegram.	
<i>Lock sources</i>	Do not use lock object Enable local lock object Enable global lock obj. Enable local and global lock object
This parameter refers to the management of global objects. Do not use lock object Lock function is not used Enable local lock object The block function is activated / deactivated only via the <Output Axx object xx> Lock Enable global lock obj The block function is only activated / deactivated via the object the <Global All> Lock object Enable local and global lock object The block function is activated / deactivated via the local object Lock or the <Global All> Lock object	
In the page dedicated to the block function for the group of interlocked relays it is possible to set the behavior of the group in case of activation and deactivation of the block, after download, etc.	

Communication objects

<Output Xx xx-xx> Command x	1 bit - On/Off CW
Use these 1-bit commands to activate / deactivate the individual relay outputs.	
<Output Xx xx-xx> Status x	1 bit - On/Off CRT
Objects for sending relay output states	
<Output Xx xx-xx> Command value	1 Byte - 0-255 CW
Use these 1 byte commands to set the relay index to be activated: 1 = active relay first of the interlocking group, 2 = active according to relay of the interlocking group, 0 =	

deactivates all the relays of the group.

<Output Xx xx-xx> Value status	1 Byte - 0-255 CRT
Object for sending the group status of the interlocked outputs: 1 = first relay of the interlocking group active, 2 = second relay of the interlocking group active, 0 = all relays of the group deactivated.	

12. Global Objects

The following communication objects are available for global functions:

OBJECTS RELATED TO ALL OUTPUTS

<Global All> All Valve Closed	1 bit - On/Off CRT
-------------------------------	----------------------

It is an object connected to the outputs that manage the valves and consequently the following blocks:

- A Electric valves
- B Servomotors
- C Fancoil 2 speeds 1 valve
- C Fancoil 1 speed 2 valves
- D Fancoil 3 speeds 1 valve
- D Fancoil 2 speeds 2 valves
- E Fancoil 3 speeds 2 valves

Each time a block of the type listed above is configured, it is possible to subordinate it to the "All Valve Closed" function. This object considers the status of the valves and sends the value 1 if at least one valve is open and the value 0 if all are closed. In this way it is possible to give consent to the pump that supplies the hydraulic circuit.

<Global All> Lock	1 bit - On/Off CW
-------------------	---------------------

This object can be used to manage the block function for multiple outputs and then to subordinate the different blocks to this global function

<Global All> Scene	1 Byte - 0-255 CW
--------------------	---------------------

Object used to manage the scenarios for multiple outputs then going to subordinate the different blocks to this global function

Global All> Dyn Scene	1 bit - En/Dis CW
-----------------------	---------------------

Object used to enable / disable dynamic scenarios

Global All> Heat / Cool	1 bit - H/C CW
-------------------------	------------------

Object used to communicate to the actuator the status of the HVAC system to manage automatic behavior on the shutters or on the valves and fan coil speeds.

OBJECTS RELATED TO SINGLE RELAY

<Global Single> Command	1 bit - On/Off CW
-------------------------	---------------------

Object used to manage global On / Off commands on single relays; in the parameters it is possible to associate the received telegram on this object to the logic function (if enabled) or to the command.

OBJECTS RELATED TO SHUTTERS

<Global Shutter> Up/down	1 bit - Up/Dw CW
--------------------------	--------------------

Global up / down control for shutters / venetians

<Global Shutter> Shutter %	1 Byte - 0-255 CW
----------------------------	---------------------

Global command position % for shutters / venetians

<Global Shutter> Louvre %	1 Byte - 0-255 CW
---------------------------	---------------------

Global command louvres position % for venetians

<Global Shutter> Alarm 1	1 bit CW
--------------------------	------------

Global alarm priority 1 for shutters / venetians

<Global Shutter> Alarm 2	1 bit CW
--------------------------	------------

Global alarm priority 2 for shutters / venetians

<Global Shutter> Alarm 3	1 bit CW
--------------------------	------------

Global alarm priority 3 for shutters / venetians

13. Inputs

Inputs are present on the IO16F01KNX and IO16F01KNX-SD modules; each input can be set as digital input for dry contacts (potential free), as output for signaling LEDs (see LED eelectron code LD00A01ACC / LD00A11ACC) and 4 of 16 can be set as analog inputs for reading temperature probes:

IN	FUNZIONE		
1	DIGITAL INPUT	OUTPUT LED	-
2	DIGITAL INPUT	OUTPUT LED	TEMPERATURE PROBE
3	DIGITAL INPUT	OUTPUT LED	-
4	DIGITAL INPUT	OUTPUT LED	-
5	DIGITAL INPUT	OUTPUT LED	-
6	DIGITAL INPUT	OUTPUT LED	TEMPERATURE PROBE
7	DIGITAL INPUT	OUTPUT LED	-
8	DIGITAL INPUT	OUTPUT LED	-
9	DIGITAL INPUT	OUTPUT LED	-
10	DIGITAL INPUT	OUTPUT LED	TEMPERATURE PROBE
11	DIGITAL INPUT	OUTPUT LED	-
12	DIGITAL INPUT	OUTPUT LED	-
13	DIGITAL INPUT	OUTPUT LED	-
14	DIGITAL INPUT	OUTPUT LED	TEMPERATURE PROBE
15	DIGITAL INPUT	OUTPUT LED	-
16	DIGITAL INPUT	OUTPUT LED	-

If only one digital input per level is used (block of 8 inputs), a complete thermostat module can be enabled as shown in the following diagram.

For the lower level of the module:

IN	FUNCTION	
1	DIGITAL INPUT	OUTPUT LED
2	TEMPERATURE PROBE + COMPLETE THERMOSTAT	
3	not used	
4	not used	
5	not used	
6	not used	
7	not used	
8	not used	

For the upper level of the module:

IN	FUNCTION	
9	DIGITAL INPUT	OUTPUT LED
10	TEMPERATURE PROBE + COMPLETE THERMOSTAT	
11	not used	
12	not used	
13	not used	
14	not used	
15	not used	
16	not used	

The inputs are divided into 2 groups of 8, the selections are made through a configuration page for each group.

14. Digital input

With DIGITAL INPUT configuration each individual input can be configured to perform one of the following functions:

- Activation on press
- Activation on press / release
- Activation on short and long press
- Dimming
- Shutter and blinds
- Scene
- Command sequences (short and long press)
- Command sequences (toggle function)
- Command sequences 1 bit
- Set RGB color
- MUR/DND function
- Loop among values

KNX PARAMETER	SETTINGS
Function	Activation on press Activation on press / release Activation short and long press Dimming Shutter and blinds Scene Command sequences (short and long press) Command sequences (toggle function) Command sequences 1 bit Set RGB color MUR/DND function Loop among values
See following paragraph:	
Activation on press Activation on press / release Activation on short and long press Dimming Shutter and Blinds Scene Commands sequences Set RGB color MUR / DND Loop among values	

Activation on press

“**Activation on press**” allows you to configure the sending of telegrams when the button is pressed; device can also be configured to send periodic messages with repetition period.

KNX PARAMETER	SETTINGS
Telegram Associated	1 bit / 1 byte
It is possible to send 1 bit or 1 byte objects	

Configurations for 1 bit object:

- On
- Off
- Toggle

Configurations for 1 byte object:

Value 0-255 (generic signed int)

Value 0-100% (scaling value in steps of 5%)

HVAC Mode (DPT_HVACMode 20.102)

KNX PARAMETER	SETTINGS
Cyclic sending when button pressed	Never
	0.3 sec.
	0.4 sec.
	0.5 sec.
	0.8 sec.
	1.0 sec.
	1.2 sec.
	1.5 sec.
	2.0 sec.
	3.0 sec.
	5.0 sec.
8.0 sec.	
10 sec.	
As long as the button is pressed, the telegram with selected size and value is sent cyclically; this parameters defines the time interval between two sendings	

Activation on press / release

“Activation on press / release ” allows you to configure the sending of telegrams when the button is pressed and when it is released.

Parameters are identical to the choice “activation on press”; one parameter is added:

KNX PARAMETER	SETTINGS
Communication object on release	disabled / enabled
if enabled, this parameter displays an additional communication object (<Button x> Release Action) that is transmitted on the release event, this object can be associated with a group address other than the one that sends the value associated with the pressure.	

Activation on short and long press

The different duration between short and long press is defined by the parameter “Minimum time long press button”.

You can set to send a telegrams with different values on short and long press or decide to send commands only on one of this events.

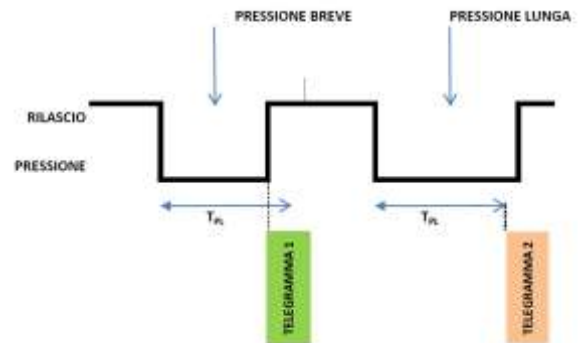

When button is pressed then counting time starts; if the button is released before time exceeds TPL time, device executes the command associated with the event of “short press” and if, on the contrary, TPL timeout expires and button is still pressed then the command associated with the **event of “long press” is executed.**

The parameters and mode of transmission of telegrams can be managed through “activation on long and short press” are the same set with the configuration “Activation of press / release ” except for the function of cyclic sending that is not provided here.

Dimming

Through the dimming function it's possible to control a light dimmer using short and long press of the buttons.

Each button uses 2 communication objects:

1 bit dimension for ON /OFF command associated to short press operation

4 bit dimension for brightness regulation associated to long press operation

Parameter “Minimum time long press button” can set the minimum duration of long press; “Dimming

mode” and “Dimming step” can define brighter or darker behaviour and step of each long press action.

Shutter and Blinds

Through the Shutter and Blind function it's possible to control Roller Shutters or Blinds using short and long press of the buttons.

Each input uses 2 communication objects:

1 bit dimension for STEP /STOP command associated to short press operation

1 bit dimension for UP / DOWN command associated to long press operation

Parameter "Minimum time long press button" can set the minimum duration of long press; "Command drive shutter" can define up or down behaviour associated to long press action.

Scene

In this configuration page it's possible to set the button for scene management: learn and recall scene commands.

These different behaviour (recall and learn) are performed through two different actions (short and long press) of the button.

Learn scene on long press action is enabled by a parameter; "Minimum time long press button" can set the minimum duration of long press.

Store scene on long press	disabled / enabled
If disable, long press action is ignored and no telegram is sent to the bus; if enable on long press action a learn scene telegram is sent to the bus.	
Object enable scene learning from bus	disabled / enabled
If this parameter is enabled you have a communication object (size = 1 bit) in order to enable / disable runtime from bus the sending of the "learn scene telegram" . When this object receives a telegram "1" then the function associated to the long press of the button (send the telegram storage scenario) is enabled, when it receives a telegram "0" the command associated with the long press is not sent.	

Commands sequences

This function allows you to associate to short and long press, sequences of different commands on the bus.

For each button this function is available for short and long press or as toggle function.

The sequence consists of 2 or 3 commands which can each be sized as 1 bit or 1 byte.

Once defined the number of elements in the sequence (2 or 3) and their size (1-bit / 1 byte), you can associate different commands to each element of the sequence or decide to send commands only on one of the two events.

The waiting time between a command and the next is fixed in 1 second.

Each object communication can be connected to a different group address.

For example it is possible to define a sequence:

KNX PARAMETER	SETTINGS
Scene Number	Number of the scene: 0 ÷ 63
This parameter sets the value of the scene you intend to learn / recall (one per channel). Remember that output devices (i.e. actuators, etc.) generally can manage several scenes, each identified by a value (that varies from 0 to 63); therefore is important to set this parameter correctly and matching the number set on the actuators.	

obj	dimension	short press (operation 1)	long press (operation 2)
A	1 bit	ON (to actuators)	OFF (to actuators)
B	1 byte	100% (to a dimmer)	0% (to a dimmer)
C	1 byte	COMFORT (to a thermostat)	ECONOMY (to a thermostat)

Set RGB color

This function allows you to associate a short press of the button to a command on the bus in order to set a RGB color. The "RGB object type" parameter defines whether the command is sent with a single 3-byte object or 3x1-byte objects. It is also possible to enable a feature associated with a long press that allows to change the color which is sent with a short press. During long press the color transition is performed and at the time of release the selected color is stored; this means that from now every time a short press is done the new color is sent on the bus. When the device is powered off and on the last selected color is kept in memory. The "Enable sending color during transition" option allows you to send all color transitions during long press so that each color can be displayed on another device.

MUR / DND

This function allows you to configure a input to send 1-bit commands with DND (do not disturb), MUR (make up room) or reset both signals - according to the sequence described below.

Value of parameter "command associated" (column "cmd") defines which values are sent on the 2 x 1 bit objects

cmd	Action	DND	MUR	Note
MUR	enable	0	1	MUR co sends "1" DND co sends "0"
MUR	disable	-	0	MUR co sends "0"
MUR	toggle	MUR enable/disable alternate		
DND	enable	1	0	DND co sends "1" MUR co sends "0"
DND	disable	0	-	DND co sends "0"
DND	toggle	DND enable/disable alternate		
Loop		0	1	Loop among these 3 sets
		1	0	
		0	0	

It is possible to associate a color to each of the 3 states (DND active, MUR active, MUR & DND not active); **it's also possible to send the same color** on the bus using a 3Byte Object DPT 232.600 RGB value 3x(0..255)

Loop among values

With this function you can configure a button to send a 1-byte value in sequence. The sequence is composed of a number of values between 3 and 9. Each time a pressure (or release according to the "active edge" parameter) is done a value is sent following the order set in ETS: from the first (A) to the last (I).

Two object are available:

<Input x> Loop Value Output	1 byte - 0..255 CW
This object is to send the values of the sequence	
< Input x> Loop Value Feedback:	1 byte - 0..255 CRT
this object is to receive a value from the bus; if it corresponds to a value set in the sequence it bring the same to the corresponding step.	

15. Led output

Each input configured as LED output can be connected to a LED (see LED eelectron code LD00A01ACC / LD00A11ACC) and configured as:

Always OFF	Led is OFF
Always ON	Led is ON
Bus controlled	Led is lit on or off upon the telegram receive from bus ; initial state and led behaviour (fixed or blink) can be configured

16. Additional probe

For inputs 2, 6, 10 and 14, if configured as analog inputs for temperature probe, the NTC probes code eelectron must be used:



TS01A01ACC (da -20°C a +100°C)
 TS01B01ACC (da -50°C a +60°C)

Maximum connection cable length: ≤ 20 m (twisted cable)

TS01B01ACC	
D1 = 9 mm D2 = 4 mm L2 = 49 mm L1 = 1250 mm NTC resistance tolerance: ± 2% Measure range -50°C ÷ +60°C Cable: 2 wire double insulation Cable colour: White NTC colour: White Warning: keep at least 3 mm from all live parts	

Additional probe - description

Using the "temperature probe" module it is possible (by connecting the NTC probe) to measure the temperature and send simple ON / OFF commands. The objects available are as follows:

<Additional Probe x> Temperature	1 bit CRT
Send temperature measurement in °C on variation and / or cyclically.	
< Additional Probe x> Upper thres.	1 bit CRT
Send On, Off or nothing when going up or down the upper threshold	
< Additional Probe x> Lower thres.	1 bit CRT
Send On, Off or nothing when going up or down the lower threshold	
< Additional Probe x> Enable thres.	1 bit CW
Enables or disables the sending of on / off telegrams	

Additional probe - parameters

KNX PARAMETER	SETTINGS
Activation telegram	Telegram 0 Telegram 1
Defines which telegram value enables sending of the threshold on / off telegrams.	

TS01A01ACC	
Dimensions in millimetres NTC resistance tolerance: ± 3% Measure range -20°C ÷ +100°C Cable: 2 wire single insulation Cable colour: Black NTC colour: Black Warning: keep at least 6 mm from all live parts	

State after download	Disabled / enabled	
Defines whether the sending of the threshold on / off telegrams is enabled or disabled after download.		
Hysteresis	0.5°C	1.0°C
	2.0°C	5.0°C
Defines the hysteresis value to be applied on the high and low thresholds		
Upper Setpoint value	-20°C ÷ +100°C TS01A01ACC	
	-50°C ÷ +60°C TS01B01ACC	
Lower Setpoint value	-20°C ÷ +100°C TS01A01ACC	
	-50°C ÷ +60°C TS01B01ACC	
Telegram when value is below setpoint	off / on / nothing	
Telegram when value is above setpoint	off / on / nothing	
Cyclic sending time of telegrams	No cyclic sending	30 min
	1 hour	2 hours

17. Temperature sensor

If only one digital input per level is used (block of 8 inputs), a complete thermostat module or a temperature sensor module can be enabled.

The temperature sensor module is similar to the "Additional Sensor" module; adds some communication objects and the possibility of averaging between the measured temperature and an eternal temperature via KNX bus:

<Temperature x> Actual Temp.	2 bytes CRT
Send temperature measurement in °C on variation and / or cyclically.	
<Temperature x> KNX probe Temp.	2 bytes CW
The measurement of another probe is received via KNX	
<Probe x> Setpoint Upper	2 bytes CW
Receives the upper setpoint via KNX bus	
< Probe x> Telegram Upper	1 bit CRT
Send On, Off or nothing when going up or down the set upper threshold	
< Probe x> Setpoint Lower	2 bytes CW
Receives the lower setpoint via KNX bus	
< Probe x> Telegram Lower	1 bit CRT
Send On	
< Probe x> Enable Input	1 bit CW
Enables or disables the sending of on / off telegrams	

18. Thermostat Function

The temperature function can be configured as a thermostat to control the temperature of a room or area by driving heating or cooling equipment / air conditioning fan coils / valves or through commands on / off to heating /cooling elements such as radiators, heat pumps, split, etc. ..



Thermostat operates temperature in a range from -9.9 ° C to + 99.9 ° C with 0.1°C resolution.

Setpoint values (including SETPOINT MODE) from the bus are accepted in a range from 10°C to 50°C

Target Setpoint Settings

The control setpoint can be changed by bus in two different ways, via one of these objects:

HVAC Mode
SETPOINT Mode

The right policy to adopt depend from the device that acts as a master, a time thermostat, a control panel or a SW supervisor. Here the list of object for changing the active mode or setpoint value by bus.

SETPOINT Object

When "Thermostat control mode" parameter is selected with the value SETPOINT MODE, object HVAC Mode is no longer visible.

Each time the thermostat receives a value on object SETPOINT MODE (2 byte size), it is used as setpoint for temperature control.

HVAC MODE obj. (switched heat / cool)

Using the HVAC MODE object (size 1 byte), it is possible to set the thermostat in one of the following modes: OFF; ECONOMY; STANDBY; COMFORT; each mode is associated with a setpoint set by an ETS parameter.

OFF mode is associated with the antifreeze setpoint in heating mode and at the high temperature protection set point in cooling mode.

HVAC MODE obj. (automatic heat / cool)

Behaviour for this value of parameter *“Thermostat control mode”* is the same as above described but the switching from heating to cooling mode and vice versa is automatic. With this setting it is necessary to set an insensitive zone as in parameter *“Dead zone”*.

Whenever temperature becomes greater than : $Setpoint\ comfort\ heating + (Dead\ Band / 2)$ active control is cooling; when temperature becomes less than: $Setpoint\ comfort\ cooling - (Dead\ Band / 2)$ active control is heating.

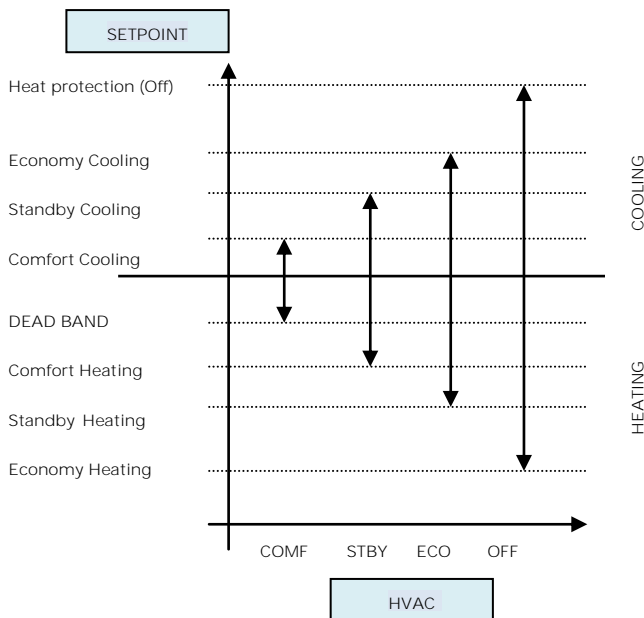

SETPOINT COMFORT, STANDBY, ECONOMY

These 2 byte objects are used to set the setpoint values for COMFORT, STAND-BY, ECONOMY mode.

Whenever change, the setpoint are in saved in memory.

After download these setpoint are reset to values according to ETS parameter; on power up these

object are set according to last values before power down.



Use these communication objects to change current setpoint for every HVAC Mode according to the current active control (heating or cooling)

COMFORT Object

COMFORT object (1 bit size) is visible only when "Thermostat control mode" parameter is selected with the value HVAC MODE.

When a telegram "1" is received thermostat goes in COMFORT mode (it applies for both heating and cooling)

On receipt of a telegram "0", thermostat returns to the mode set by HVAC MODE object.

COMFORT mode can be set also with timing: after a time set by a parameter thermostat returns in the previous mode.

KNX PARAMETER	SETTINGS
Comfort Object	Time limited Time unlimited
Comfort Overwrite Time	1.. 255 (minutes)

WINDOW CONTACT Object

This object, if enabled, has higher priority than HVAC MODE, SETPOINT MODE, COMFORT objects.

When a telegram is received ("0" or "1") on the communication object WINDOW CONTACT thermostat enters a power saving mode:

BUILDING PROTECTION (if running in HVAC MODE) or Setpoint antifreeze /high temperature protection (if running in SETPOINT MODE)

If the telegram received indicates that the window is opened, thermostat change its mode or setpoint after 1 minute from the reception of the telegram.

When it receive a telegram corresponding to state **“window closed”** it restores the previous mode,

always with a delay of 1 minute . The value of SETPOINT ADJUSTMENT (if enabled) is always restored.

SETPOINT ADJUSTMENT object

The object SETPOINT ADJUSTMENT allows you to temporarily change the setpoint value used by the thermostat applying an offset to the current value. If the thermostat is operating in "HVAC MODE" the offset value is applied from the time of receipt of a valid telegram on object SETPOINT ADJUSTMENT until this value does not change, even in case of change of the active mode (Comfort and Standby); when device enters Economy mode this value can **be reset or not according to the parameter "Reset delta setpointon HVAC economy"**. Entering Building Protection mode the value of object SETPOINT ADJUSTMENT is forced to 0.

Similarly, if the thermostat is operating in SETPOINT MODE the offset value is applied also when the setpoint value received on this object changes.

KNX probe temperature obj.

It is possible to enable the reading of a second external probe which sends the measurement data to the thermostat via the communication object ADDITIONAL TEMPERATURE of size 2 bytes.

Surveillance time for KNX probe	10..255 (min)
Whenever the thermostat receive a valid data from KNX probe it consider this value in the calculation of the measured temperature and reset the internal time (monitoring time).	

 If KNX probe is enabled the monitoring time is used to check if the additional temperature sensor periodically sends valid data to the thermostat. This mechanism avoids to consider as valid some data which can be old hours or days, for example if the additional sensor should fail or the thermostat could not receive data for long time.



It is strongly recommended to set a value for surveillance time of the additional sensor more than twice of the period set for the cyclical sending of the additional sensor.

ACTUAL SETPOINT object

The ACTUAL SETPOINT object send the setpoint in use and is sent every time:

- The value of HVAC mode object changes
- The value BASE SETPOINT changes
- The value of SETPOINT ADJUSTMENT object changes
- After download
- One minute after power on

Two points on/off

Control algorithm "2 points on / off" is used to control heating or cooling elements that can be controlled by switching on and off of the same elements, radiators, under floor heating with on-off valves, boilers, etc. ..

When the thermostat switches to "winter mode" (heat mode) sends a off command on object ON/OFF COOLING and operates the control only through the object ON/OFF HEATING (the object ON/OFF COOLING is therefore not updated anymore until it returns in "cooling mode").

Therefore in the transition from " winter" to **"summer" mode sends a off command** on ON/OFF HEATING commands and activates the control through the object ON/OFF COOLING

on/off control in heating mode:

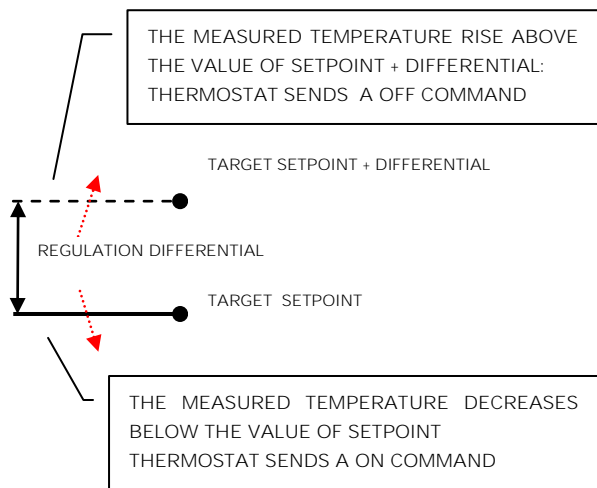

on/off control in cooling mode:

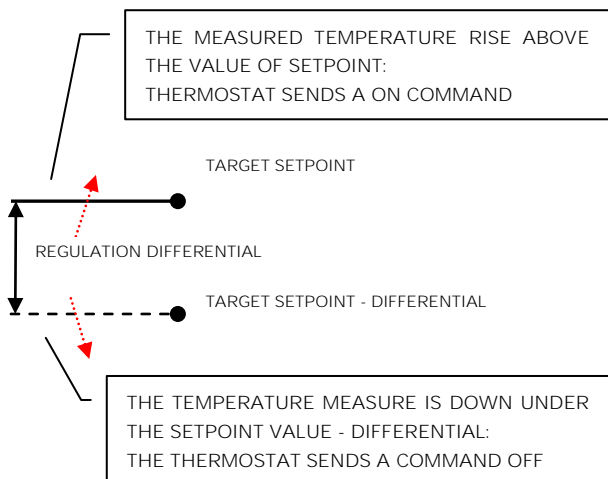

Integral proportional control PWM

Integral proportional control with PWM is an algorithm that reduces the effects of hysteresis around the set point value by adjusting the controls on the values ranging from 0% to 100% where 0% means "control off" and 100% means "maximum control action".

Once a cycle time is defined the thermostat sets the actuator to ON for a fraction of the cycle time and OFF for the remaining part. Driving the actuator with the control value of 80% means that it is active

(i.e., ON) for 80% of cycle time and OFF for the remaining 20%

KNX PARAMETER	SETTINGS
Cycle time (TCp)	10, 20, 30, 60 min
It defines the time interval.	
Proportional band (Bp)	1, 2, 3, 4, 5 °C
The proportional band BP is a range of temperatures between "Setpoint" and "Setpoint-Bp" in heating mode and between "Setpoint" and "Setpoint+Bp" in cooling mode, within this interval thermostat controls the temperature using the proportional algorithm; outside It drives actuator always in ON or OFF. When temperature is inside this range device wait the end of the cycle time before calculating the duty cycle of the next cycle. When temperature is outside of this range : below "Setpoint-Bp" in heating mode or above "Setpoint+Bp" in cooling mode it starts a new cycle as soon as temperature enters the Bp	
Integration time (Ti)	5 .. 250 min
Defines the integration time	

Integral proportional contr. continuous

This setting is very similar to "Integral proportional control with PWM" in terms of algorithm and parameters. This mode uses a 1 byte object (% value) to send the command on the bus .

Fan coil on/off

Fan coil is a device that controls the flow of cooling / heating liquid driving a valve (2-pipe fan coil) or two valves (4-pipe fan coil).

Liquid exchanges heat/cool with the environment through a ventilation system controlled by a fan. The fan is driven by an engine that typically has 3 windings that can be enabled at 3 distinct speeds.

Control logic for a 3 speed fan coil in heating:

Control logic for a 3 speed fan coil in cooling:

When temperature increasing

When temperature decreasing

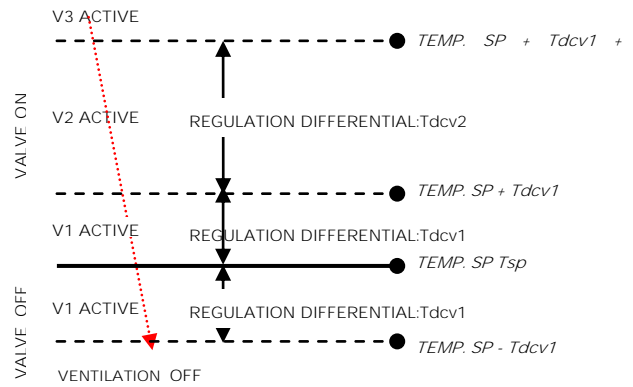
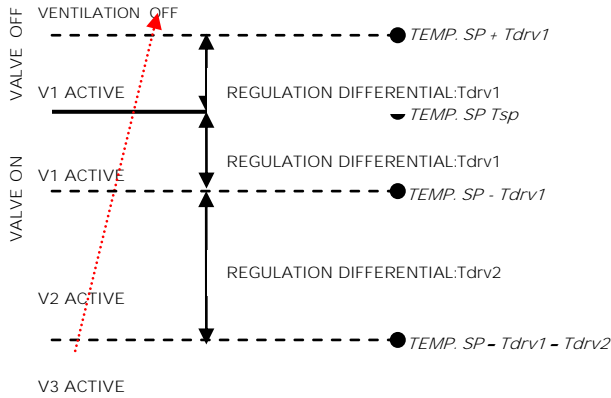

When temperature decreasing

When temperature increasing

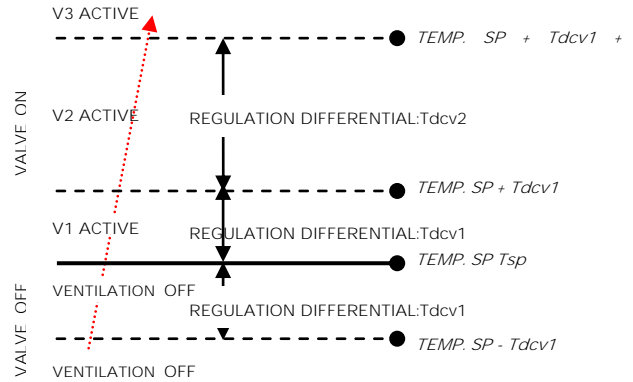
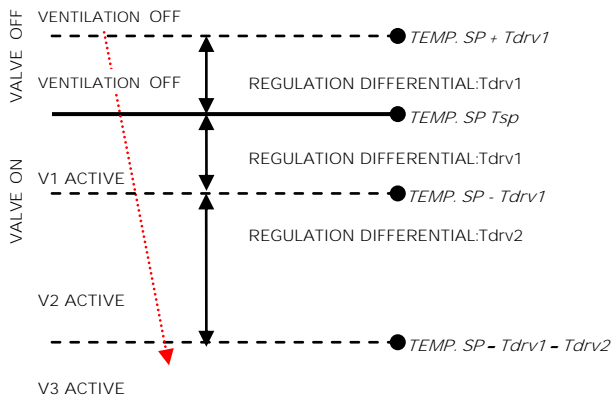

Where:

Where:

- T_{sp} : Target setpoint temperature
- T_{drv1} : regulation differential in heating for V1 Speed
- T_{drv2} : regulation differential in heating for V2 Speed

- T_{sp} : Target setpoint temperature
- T_{dcv1} : regulation differential in cooling for V1 Speed
- T_{dcv2} : regulation differential in cooling for V2 Speed

Additional valve 6 ways

Fan coil control PI

Logic and parameters are the same used in On/off with PWM control mode; the difference is that now the proportional value is sent to the bus via a 1 byte object format as a % value from 0% to 100%.

This mode is useful to control fan coils (selecting 2 or 4 pipes) or generic proportional actuators as valve drivers only linking the 1 byte communication object and avoiding to link the valve objects.

CONTINUOUS CONTROL object

This 1 Byte object send % control value to actuator.

The additional valve also manages commands for 6-way valves in which the control value from 0% to 100% defines both the percentage of valve opening and the passage of hot or cold fluid.

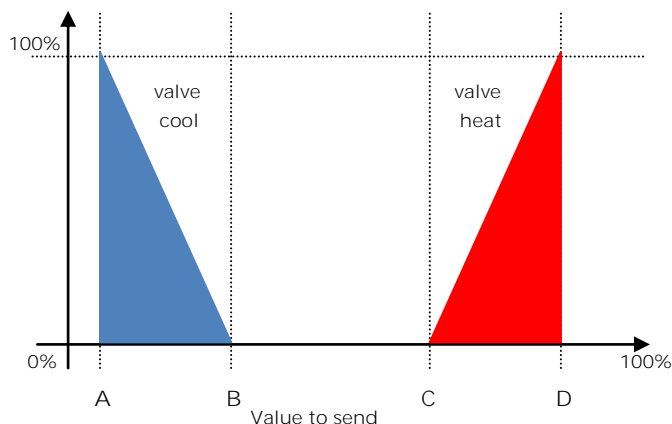

Additional valve



In fan coil mode it is possible, in 4 pipes systems to enable an additional valve object.

This object is used when the thermostat has to manage 2 different system, one in heating and one in cooling.

Suppose to have a system when floor heating is required in heating mode and a 3 speed fan coil system is required in cooling mode.

To manage this system it is necessary to :

- Set parameter "Thermostat option > use thermostat to control fan coil" = yes
- Set parameter "Fan coil ON - OFF control>Enable fan speed on" or "Fan coil continuous control > Enable fan speed on" =cooling
- Set parameter "Fan coil ON - OFF control > System type" or "Fan coil continuous control > System type" = 4 pipes
- Set parameter "Enable additional valve"=enabled
- Set parameter "Additional valve>Enable valve when"=heating
- Set parameter "Additional valve>Control algorithm" = according to your system request

KNX PARAMETER	SETTINGS
Percentage 100% cool	0% ÷ 30%
Value to be sent to bring the cold valve to 100% open position [point A on the diagram]	
Percentage 0% cool	23% ÷ 53%
Value to be sent to bring the cold valve in closed position (0% open) [point B of the diagram]	
Percentage 0% heat	47% ÷ 77%
Value to be sent to bring the hot valve to the closed position (0% open) [point C of the diagram]	
Percentage 100% heat	70% ÷ 100%
Value to be sent to bring the hot valve to 100% open position [point D on the diagram]	
Value to send for valve fully closed	36% ÷ 66%
Value to be sent to bring both the cold and hot valves to the fully closed position. [area of the diagram between B and C]	

For the additional valve, in 6-way mode, it is possible to define different control differentials around the setpoint value as shown below:

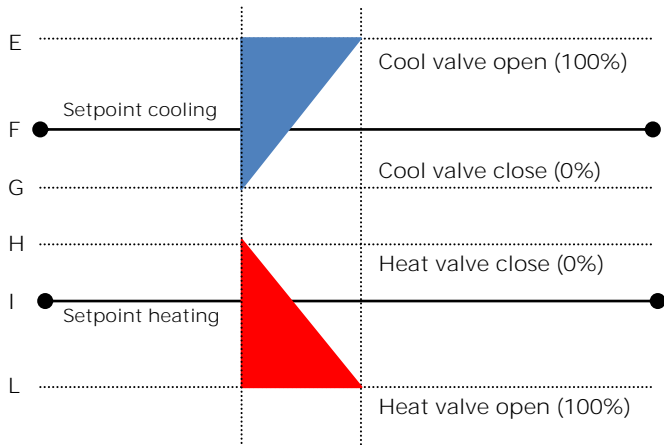

This makes it possible to adjust the opening and closing of the additional valve independently of the speed control (for example, once the setpoint has been exceeded, a maintenance action can be taken keeping the valve open again without activating the speeds)

KNX PARAMETER	SETTINGS
Regulation differential valve 0%	0°C ÷ 5 °C
Defines the width of the F-G bands for cooling and H-I for heating	
Regulation differential valve 100%	0°C ÷ 5 °C
Defines the width of the E-F bands for cooling and I-L for heating	

Force fan coil speed

In fan coil operation (in 1-bit or 1-byte mode), you can force the use of just one speed and bypass the automatic speed selection. This mode is useful, for example, in small rooms such as hotel rooms, for example or in any case where the fan speed may bring noise. To activate forcing, you must act on the 1-bit object that selects AUTO / MAN and then on the object that activates the desired speed (3x1 1-bit object or 1 object at 1-byte in% mode)

Ventilation mode

When using fan coil, you can also activate "fan" or "ventilation" mode. In this mode, the fan coil will

never turn off the fan even when, after reaching the desired setpoint, the heat / cool valve closes. To select the fan speed used in ventilation mode the **"force fan speed object" must be set, in fact in AUTO mode the ventilation stops when setpoint is reached.** It is also possible to make the "ventilation" mode always active without having to turn it on / off via a communication object.

Temperature probe failure / out of range measurement



If the temperature probe is disconnected or in short circuit the control action is interrupted and the controlled actuators are switched off.



The value of temperature sent on the bus in case of probe disconnection or short circuit or for out of range measured value is 0 °C (according to KNX DPT_Value_Temp 9.001)

Temperature alarm object

Alarm objects are available for each thermostat and for each temperature probe; in case of probe failure or out of range measurement, a telegram with value "1" is sent to the bus on a 1-bit communication object; as soon as the temperature sensor is operating again, the value "0" is transmitted.

To correctly manage the internal or rear sensor or KNX sensor via bus, refer to the following configuration modes:

CONFIGURATION MODE 1
Only probe connected to input
if the temperature probe is disconnected or short-circuited, the monitoring action is interrupted and the controlled actuators are deactivated.
probe / short circuit disconnection / out of range measurement:
Obj "Temperature" is not send
Obj "Alarm" send "1"

CONFIGURATION MODE 3
Only KNX temperature via bus
The KNX probe is read considering the last value received on the Obj "KNX probe temperature".
If the KNX probe value is out of range or the monitoring time expires without any received message, the thermostat starts by considering only the internal probe until it receives a new valid value from the KNX probe; in this case the additional value is counted again.
Obj "Alarm" send "1" until KNX temperature is received again.

CONFIGURATION MODE 3
Mix of probe connected to input and KNX temperature via bus
The KNX probe is read by considering the last value received on the OBJ "KNX temperature probe".
The value of the temperature sent on the bus is the weighted average between the values of the front probe and KNX.
If the value of the KNX probe is out of range or the monitoring time expires without having received any message, the thermostat starts by considering only the other probe until it receives a new valid value from the KNX probe; in this case the bus value is again considered.

19. Thermostat behaviour on bus failure, recovery and download

Behaviour on bus voltage failure

On failure of bus voltage no actions are executed by the device; behaviour of controlled actuators must be set using their own parameters.

Behaviour on bus voltage recovery

On bus voltage recovery all the communication objects are set to 0 except for objects for which a parameter is defined for the initial value; thermostat keeps these values in memory and restore them after recovery:

- Heat / Cool mode
- HVAC Mode
- Base Setpoint
- Setpoint Adjustment
- Force value in manual mode
- Ventilation

Control values (i.e. commands to actuators) are calculated using actual setpoint and temperature.



After power on device recalculates the commands to actuators and switch them on, if necessary, otherwise does not carry out any action; you are recommended to set the behaviour of actuator in order to switch the heating / cooling equipment off after bus power on.

Behaviour on ETS Download

After download it's possible to set initial value of:

Heat / Cool mode
 HVAC Mode
 Ventilation

For other communications objects the behaviour is identical to bus voltage recovery.

20. Wrong application download

If the wrong ETS application is downloaded then KNX/EIB led starts blinking and device is not operative on the bus. A power reset must be done or the correct ETS application must be downloaded.