

K-BUS Universal Interfaces

User manual-Ver. 1

KU/I0401.1

Intelligent Installation Systems

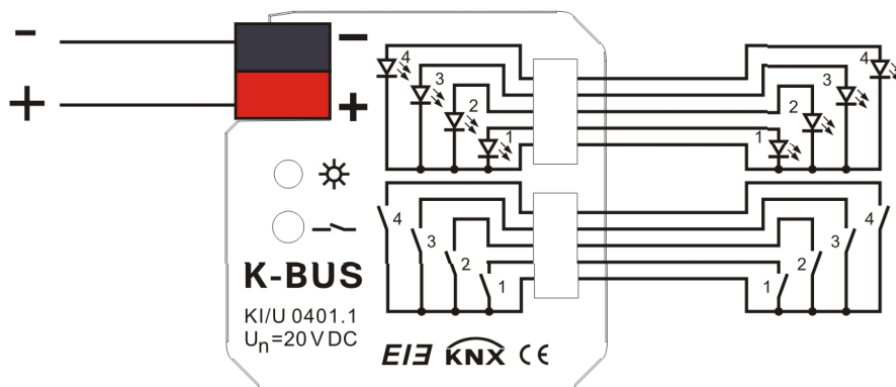
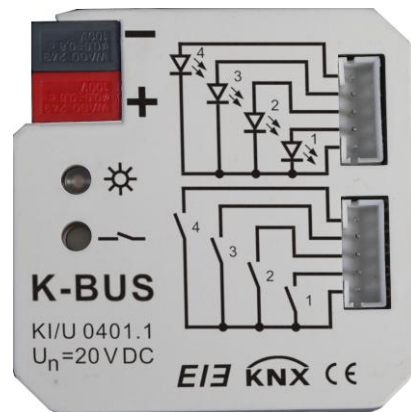

Contents

1. General-----	3
1.1 Product and functional overview -----	3
2. Technical data -----	3
3. Dimension and Connection diagram -----	4
3.1 Dimension drawing -----	4
3.2 Connection diagram-----	5
4. Project design and programming -----	5
4.1 Overview of the functions-----	5
4.2 Description of setting the system parameter in part of device channel-----	6
4.2.1 Parameter window “General Setting” -----	6
4.2.2 Parameter window “Switch X” -----	7
4.2.3 Parameter window “Switch/dimming, X” -----	12
4.2.4 Parameter window “Value/force output, X” -----	14
4.2.5 Parameter window “Scene control, X” -----	17
4.2.6 Parameter window “Switching sequence, X” -----	21
4.2.7 Parameter window “Counter, X” -----	23
4.2.8 Parameter window “Multiple operation, X” -----	27
4.2.9 Parameter window “Shutter control, X” -----	29
4.3 Description of setting the system parameter in part of LED channel -----	31
4.3.1 Parameter window “Flashing, X” -----	32
4.3.2 Parameter window “Switch, X” -----	33
4.3.3 Parameter window “Control by input, X” -----	35
4.3.4 Parameter window “Indicate object in, X” -----	35
4.3.5 Parameter window “Indicate object out, X” -----	36
4.3.6 Parameter window “Indicate object in and out, X” -----	37
5. Description of communication object -----	38
5.1 Communication object “swith” -----	39
5.2 Communication object “switch/dimming” -----	39
5.3 Communication object “value/force output” -----	40
5.4 Communication object “scene control” -----	40
5.5 Communication object “switch sequence” -----	41
5.6 Communication object “counter” -----	42
5.7 Communication object “multiple operation” -----	43
5.8 Communication object “shutter control” -----	43
5.9 Communication object “LED X—flashing” -----	44
5.10 Communication object “LED X—SWITCH” -----	45

1. General

The Universal Interfaces can install to be system with EIB/KNX bus and other device, which are mainly use in building control system. The functions are both simple to operate and intuitive, users can program it according to the requirement to implement the function systematically.

This manual provides detailed technical information about the Universal Interfaces for users as well as assembly and programming details, and explains how to use the Universal Interfaces by the application examples.

1.1 Product and functional overview

The Universal Interfaces achieve the functional applications via conventional push buttons/switches, communicate by technical binary, which are used to control the devices such as the Dimmer Actuator/the Relay Actuator, to control domestic appliance indirectly. At the same time, they also enable the control of LEDs. The extremely compact design enables the device to be inserted in a conventional 60 mm wiring box.

The Universal Interfaces connect to the bus though the EIB connection terminals and have no use for additional supply voltage. It is available to assign the physical address and set the parameters by Engineering design tools ETS with VD2/VD3 (higher than edition ETS2v1.3).It is able to install VD3 file if use ETS3 software.

The Universal Interfaces have many functions that can be used in a wide variety of application areas. The following list provides an overview:

- ✧ Switching and dimming function.
- ✧ Control of blinds and shutters.
- ✧ Sending of values e.g. temperature values、 water line.
- ✧ Invoke and storing of scenes.
- ✧ Trigger an LED for reporting an operation.
- ✧ Operation of various loads by multiple push button actions.
- ✧ Operation of several loads in a fixed switching sequence.
- ✧ Standard counting and differential counting.
- ✧ Each channel of a device can adopt any of the functions described above.

2. Technical data

Power supply	Bus voltage	21~30V DC, via the EIB bus
Input/output	4 channels	Can be individually parameterized as inputs or outputs Bus length ≤10M
Input	Scanning voltage	20 V DC
	Input current	5 mA

Output	Output voltage	5V DC
	Output current	max.2.5mA, limited via series resistor of 2 K Ω
	Safety	Short-circuit-proof, overload protection, reverse voltage protection
Operating and display elements	(Red) LED and push button	for assigning the physical address
	(Green) LED flashing	Indicate the application layer works normally
Connections	Input/output	2*5-pin cables, approx. 30 cm long, can be extended to max. 10 m
	EIB bus	via bus connecting terminal
Ambient temperature range	Operation	-5°C...45°C
	Storage	-25°C...55°C
	Transport	-25°C...70°C
Miscellaneous	Type of protection	IP20 (EN60529) when installed
	Protection class	III
	CE norm	in accordance with the EMC guideline and the low voltage guideline
	Certification	EIB-certified
	Mounting	in switch box, 60 mm
	Dimensions	46×46×11.7mm
	Weight	0.05 KG

3. Dimension and Connection diagram

3.1 Dimension drawing

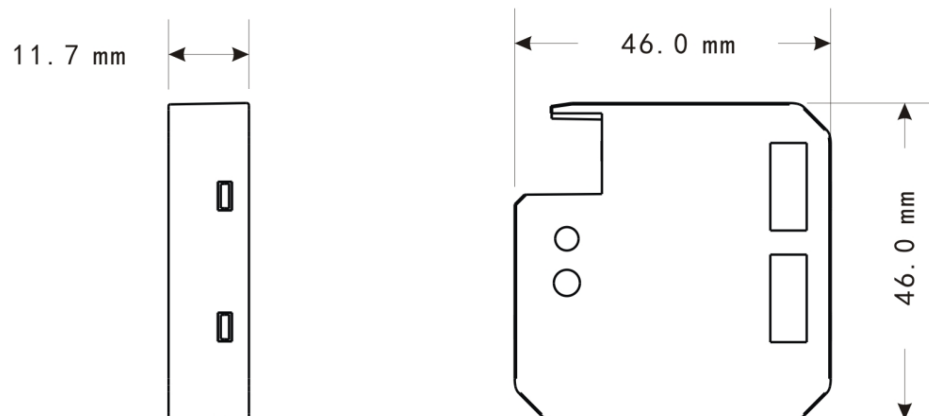

3.2 Connection diagram

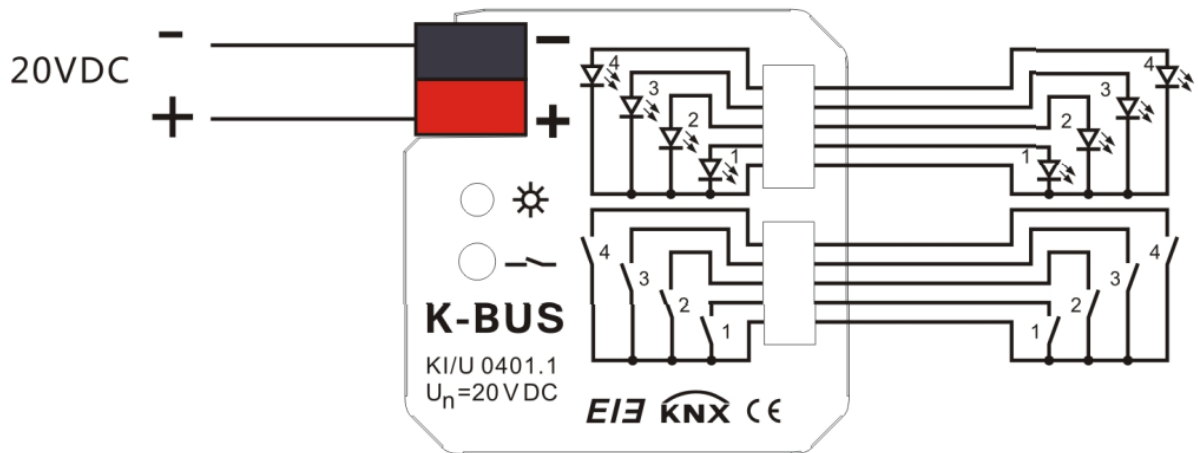

4. Project design and programming

4.1 Overview of the functions

Application program	Number of communication objects	Max. number of group address	Max. number of associations
Binary Input display, 4f/1	40	80	80

The following functions can be set separately for each input:

Switch sensor: For switching the lighting or scanning a floating contact; Distinction between short/long operation and cyclical sending of the contact state are possible.

Switch/dimming sensor: For switching/dimming the lighting; There are start/stop dimming and stepwise dimming, as well as dimming via a single push button are possible.

Value/Forced operation: For sending the valued of different data types(e.g. temperature values). It is possible to send different values or data types for short/long operation, possible to activate/deactivate the forced operation of actuators.

Control scene: For recalling and storing the states of several actuator groups. The actuator groups can either be controlled via max. 5 individual objects or via an 8 bit scene object.

Switching sequence: For the operation of several actuator groups in a preselected sequence, e.g. the latching relay.

Counter: For counting input pulses. Various data types of the counter can be set. It is able to set the counting rate, whether to sending the current counting values cyclically and the differential counter when enables an additional counter. The differential counter can be reset and run out in report, thereby, it is convenient to count the daily consumption.

Push button with multiple operations: For triggering various functions depending on the frequency of the operation. A long operation can also be detected and a function can be triggered.

Shutter sensor: For movement and adjustment of a shutter or blind. Eight present operation modes are possible in total.

Control LED: For controlling a light-emitting diode, switching and flashing. As the switch,

it is with time limit that turns off automatically after a preset time; as the flash, it is able to set the flashing rates.

4.2 Description of setting the system parameter in part of device channel

Parameters and objects in the device application are outlined in this section. Parameters and objects which are assigned to each channel, are equivalent and described in the following sections using output A as an example.

4.2.1 Parameter window “General Setting”

Parameters for the functions which affect the complete device can be set via the Fig. 1.

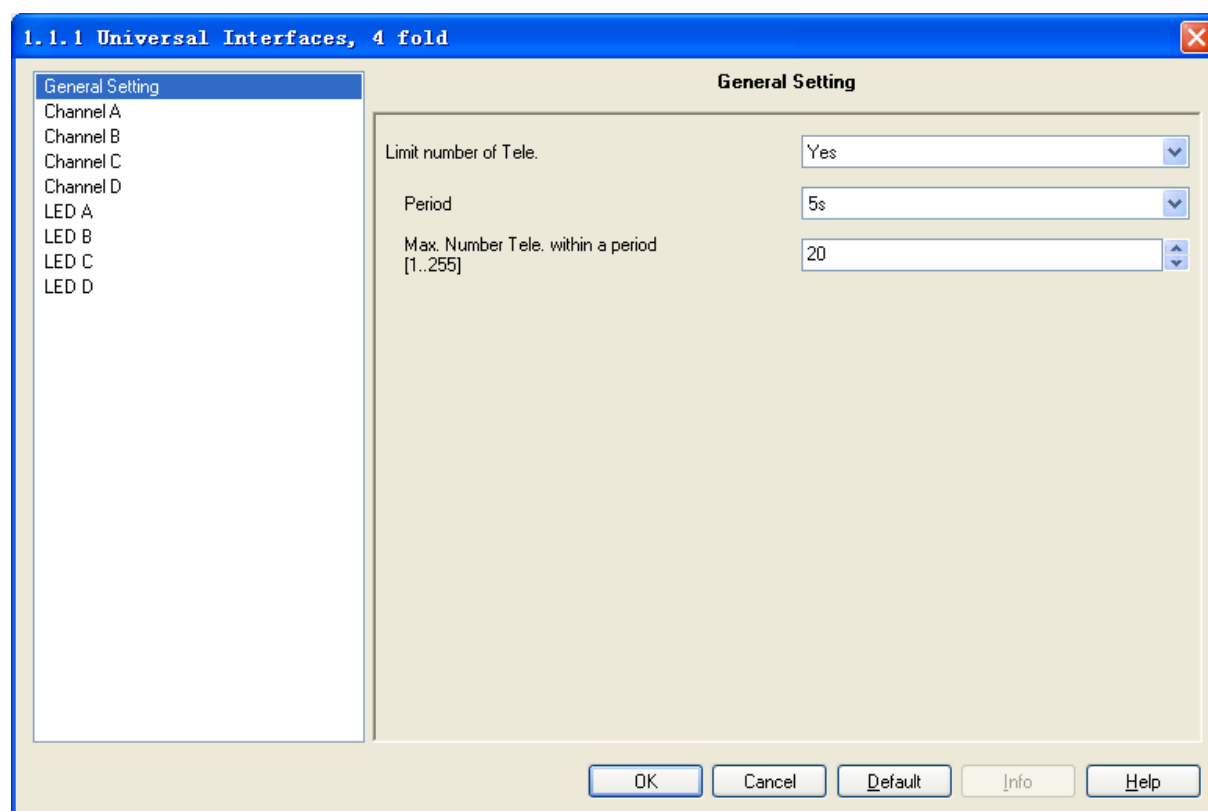

Fig. 1 parameter window “General Setting”

Parameter “Limit number of Tele.”

It is used to limit the number of sending telegrams to decrease the burden of bus. It is possible to set how many telegrams can be sent within an adjustment period.

Options: Yes
No

Parameter “Period”

It is able to set the limit time of sending telegrams.

Options: 100ms
500ms
1s
.....
1min
10min

Parameter “Max. Number Tele. Within a period [1...255]”

It is able to set the Max. number of sending telegrams within a setting period.

Options: 1~255

4.2.2 Parameter window “Switch X”

Parameter window “Switch X” can be shown in Fig.2 and Fig.4. Fig.2 do not distinguish between long and short operation while Fig.4 opposite.

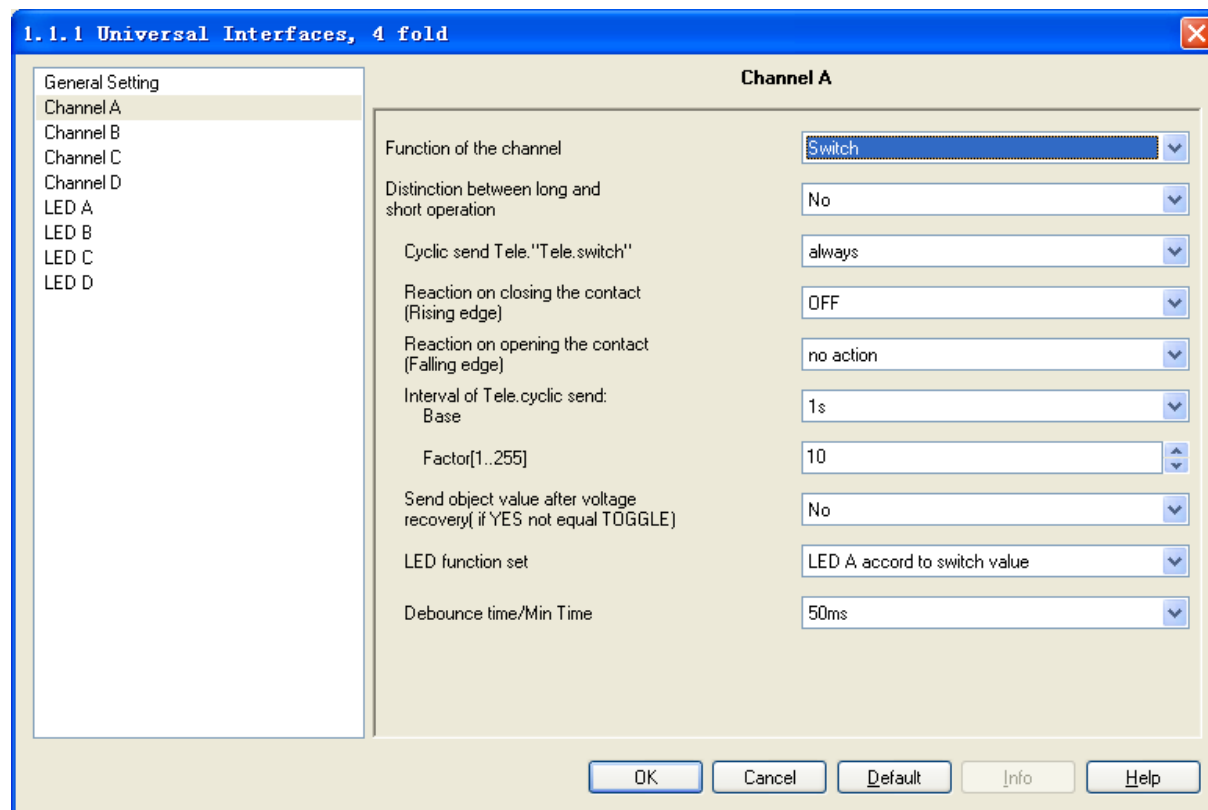

Fig.2 Parameter window “Switch X”(do not distinguish between long and short operation)

Parameter “function of the channel”

The parameter determines the function option in the channel; the current option is “switch”. If “No function” is selected, it means the channel is disabled.

- Options:
- No function
 - Switch
 - Switch/Dimming
 - Value/Forced output
 - Scene control
 - Switching sequence
 - Counter
 - Multiple operations
 - Shutter Control

Parameter “Distinction between long and short operation”

This parameter sets whether the input distinguishes between a short and long operation. If “yes” is selected, there is a waiting period after the opening/closing of the contact to determine whether the operation is long or short. Only then is a possible reaction triggered. The following drawing clarifies the function:

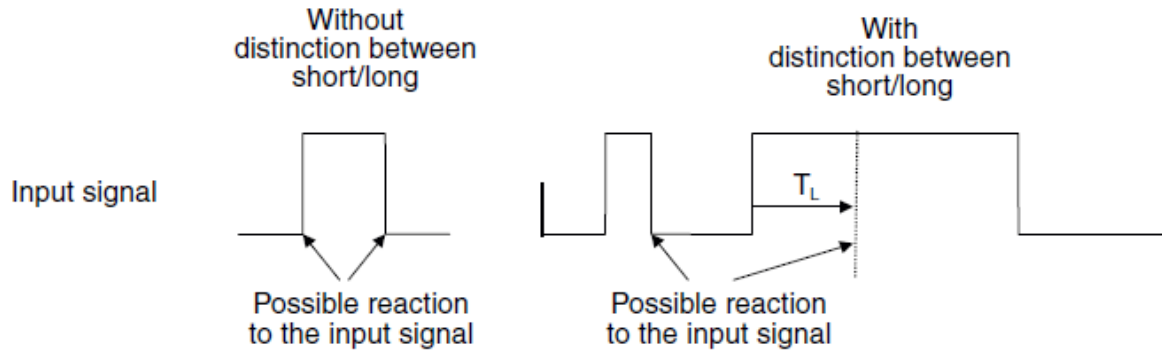

Options: Yes
No

Note: The long operation in the below chapters are the same with here.

Parameter “Cyclic send Tele. ‘Tele. Switch’”

This parameter is visible if there is no distinction between a short and long operation. It is able to set whether to send the current value of object “Tele. Switch, X” cyclically on the bus.

Options: No
Always
If switch off
If switch on

If the parameter value “always” is selected, the object sends cyclically on the bus, regardless of its value is 0 or 1. If the parameter value “if switch off” or “if switch on” is set, only the corresponding object value is sent cyclically.

Parameter “Reaction on closing the contact (rising edge)”/ “Reaction on opening the contact (fall edge)”

This parameter is visible if there is no distinction between a short and long operation. It can be set the operation to open and close the contact.

Options: No action
Off
On
Toggle
Stop cyclic transmission

If the parameter “Toggle” is selected, negate the operation, that means negate the current value. For example, if “On” is selected, when negate it will carry out “Off” operation. If the parameter “Stop cyclic transmission” is selected, it will stop the cyclical sending telegram till there is a new object value to be sent. If the parameter “No action” is selected, it will not implement any operation.

Parameter “Interval of Tele. Cyclic send: Base×Factor”

This parameter is used to set the interval time between two telegrams that are sent cyclically, it is visible if cyclical sending has been set. Transmission cycle time =Base×Factor.

Base options: 1s
10s
...
1h

Factor options: 1...255

Parameter “Send object value after voltage recovery (if yes not equal toggle)”

It can be set whether to send the value of the object “Tele. Switch, X” on the bus after voltage recovery, this parameter is visible if there is no distinction between a short and long operation.

Options: Yes
No

If the parameter “Yes” is selected, it will send the current value of the object “Tele. Switch, X” on the bus. Only when the value “Toggle” has not been set in either of the two parameters “Reaction on opening/closing the contact”, the value of the object “Tele. Switch, X” can be send on the bus. If one of the two parameters has the value “TOGGLE”, no values are sent in general on the bus after bus voltage recovery. If “No reaction” or “Stop cyclic transmission” is selected, there is no values are sent on the bus either.

Parameter “LED function set”

This parameter set the LED direction to indicate the status according to the object “Tele. Switch, X”. There are A, B, C, D 4 LEDs to choose, each LED has 2 options. If the parameter “LED X accord to switch value” is selected, LED indicate status is the same with the current value of the object “Tele. Switch, X”; if the parameter “LED X toggle by switch value” is selected, LED indicate status is negate to the current value of the object “Tele. Switch, X”.

Options: No action
LED A accord to switch value
LED A toggle by switch value
.....
LED D accord to switch value
LED D toggle by switch value

Note: If the four channels invoke the same option, the priority of channel A is the highest, it will indicate the status according to the value of the object “Tele. Switch, X” in channel A. Then the priority of channel B is higher, then it’s C, the last is D. The priority of LED X in function channel in the device is higher than the LED X channel, the LED X can not be implement any operation in channel LED X which is used in the function channel in the device. If the parameter “LED function” is set “LED A accord to switch value” or “LED A toggle by switch value” options, the operation had been set in LED A can not be carry out.

Parameter “Debounce time”

It can set the vibration time to prevent unwanted multiple operation by bouncing of contacts in vibration time, which means the effective time of the contact operation.

Options: 10ms
20ms
.....
150ms
Min. operation

The “minimum operation” time can only be set when there is no distinction between a short and a long operation. This parameter is different from others, the effective time of the contact operation is not only means the effective time when contact close, but also the contact open. The parameter window can be shown in Fig. 3:

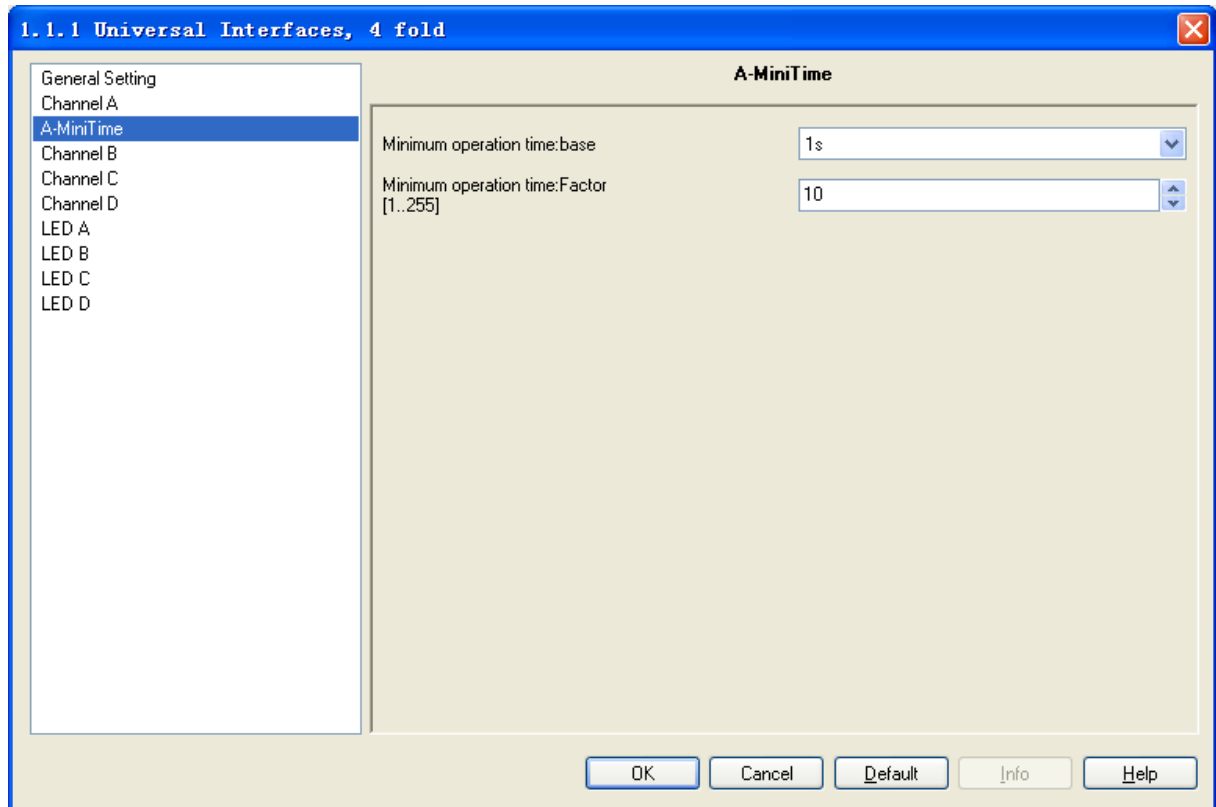

Fig. 3 Parameter window “X-Mini Time”

Parameter “Minimum operation time: Base × Factor”

The effective time of the contact operation is: Base × Factor

Base options: 100ms

.....

1min

Factor options:1~255

Note: The parameter window and the explanation of parameter “Min. operation” in the “Debounce time” in the below chapters are the same with here.

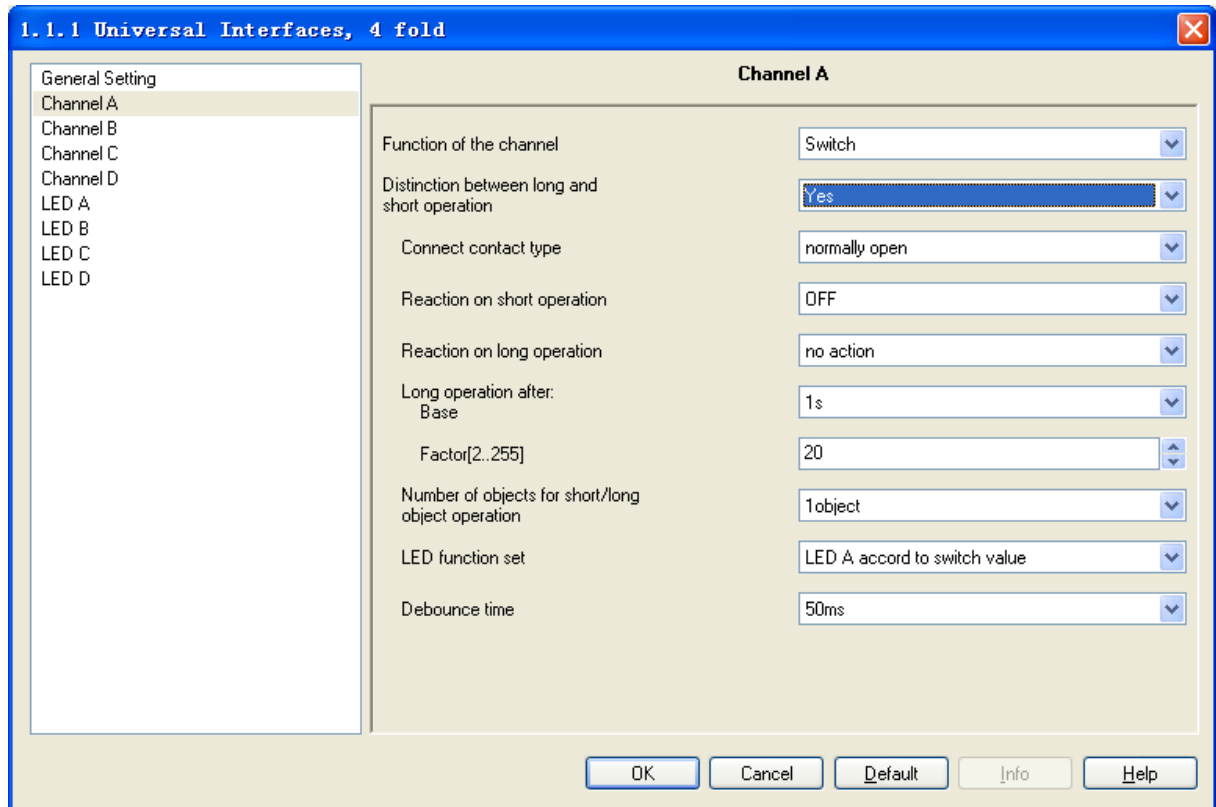

Fig. 4 Parameter window “Switch X” (distinguish between a short and long operation)

Parameter “Connect contact type”

This parameter is visible when there is a distinction between a short and long operation, it is used to define whether the contact is a normally open contact or a normally close contact in general.

Options: Normally open
Normally close

The parameter introduced in this chapter is use “Normally open” as the example; the normally close is just opposite.

Parameter “Reaction on short operation” or “Reaction on long operation”

This parameter is visible when there is a distinction between a short and long operation. It is able to set the operation when preset a short and long operation. When the button operation is confirm to a short or a long operation, the object value will be update immediately.

Options: No action
Off
On
Toggle

Parameter “Long operation after: Base× Factor”

This parameter is visible if there is a distinction between a short and long operation. The period TL is defined here, after which an operation is interpreted as “long”. $TL = Base \times Factor$

Base options: 100s
1s
.....
1h

Factor options: 2~255

Parameter “Number of objects for short/long object operation”

This parameter is visible if there is a distinction between a short and long operation. It is able to set one or two communication objects, when one communication object is set, long and short operation share one communication object; when two communication objects are set, long and short operation use one communication object separately.

Options: 1 object
2 objects

4.2.3 Parameter window “Switch/dimming, X”

Parameter window “Switch/dimming, X” will be shown in Fig. 5, it is visible when Function of the channel “Switch/Dimming” is selected. The function enables the operation of dimmable lighting. 1 button operation is also possible.

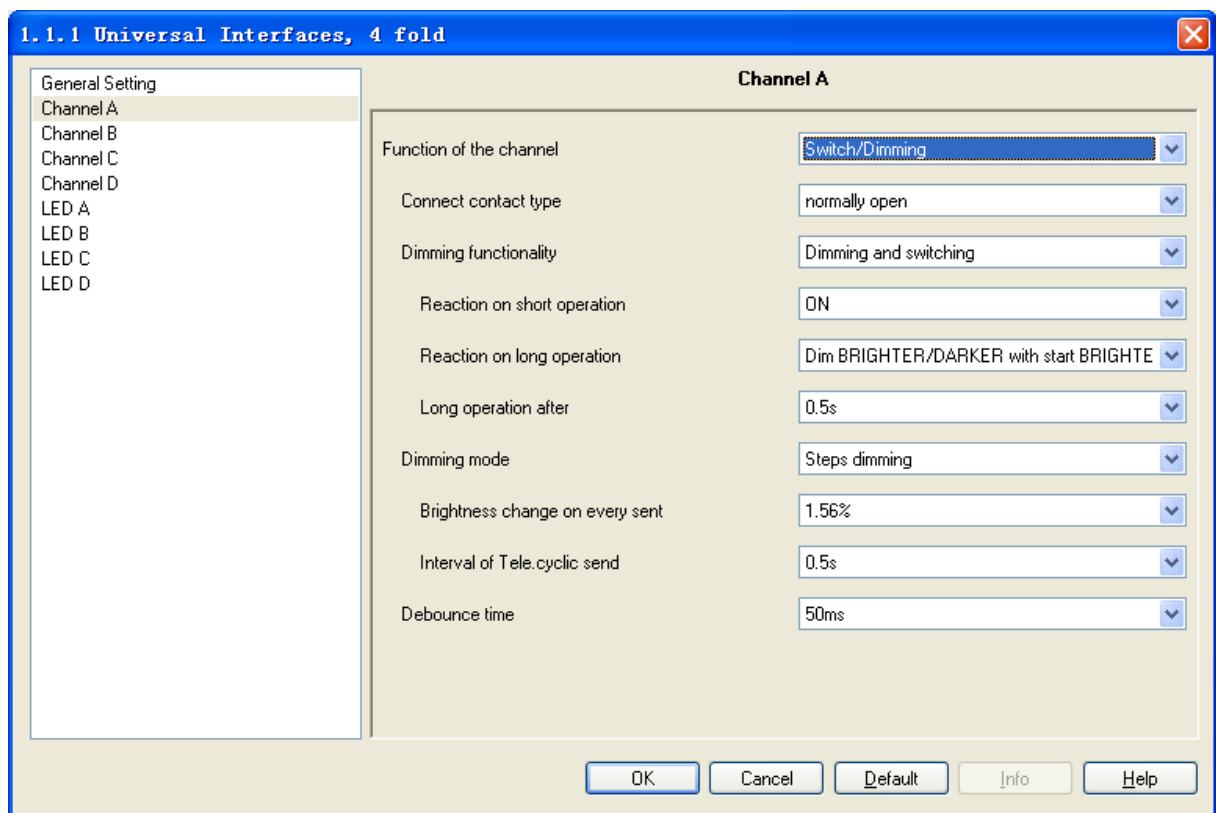

Fig. 5 Parameter window “Switch/Dimming”

Parameter “Connect contact type”

This parameter defines whether the contact at the input is a normally open contact or a normally closed contact.

Options: Normally open
Normally open

The parameter introduced in this chapter is use “Normally open” as the example, the normally close is just opposite.

Parameter “Dimming functionality”

This parameter determines whether the lighting is only dimmed or whether it should also be switched.

Options: Dimming and switching

Only dimming

If the parameter “Only dimming” is selected, there is no distinction between a short and long operation. The dimming command is therefore carried out immediately after the push button action; there is no delay to determine whether the operation is long or short. If the parameter “Dimming and switching” is selected, the push button action need to delay to determine whether the operation is long or short. In this case, the lighting is dimmed via a long operation and switched via a short operation.

Parameter “Reaction on short operation”

This parameter is visible if the value “Dimming and switching” has been set in the parameter “Dimming functionality”. It is able to set the operation after triggered the object “Switch, X”, that’s a short operation.

Options: No action

Off

On

Toggle

Parameter “Reaction on long operation”

This parameter is visible if the value “Dimming and switching” has been set in the parameter “Dimming functionality”. It is able to set a dim brighter or a dim darker after a long operation.

Options: Dimming brighter

Dimming darker

Dim brighter/darker with start brighter

Dim brighter/darker with start darker

The parameter “Dim brighter/darker with start darker” is selected, it can be dim brighter or dim darker after a long operation, it is just dim darker first and the latter operation negate.

Note: The long and short operation is individual; they are not operation on one object.

Parameter “Long operation after”

This parameter is visible if the value “Dimming and switching” has been set in the parameter “Dimming functionality”. The period TL is defined here, after which an operation is interpreted as “long”.

Options: 0.3s

0.5s

.....

10s

Parameter “Reaction on operation”

This parameter is visible if the value “Only dimming” has been set in the parameter “Dimming functionality”. There is no distinction between a short and long operation. The operation and the option of the parameter “Reaction on long operation” are the same. It is able to set a dim brighter or a dim darker after a long operation.

Options: Dimming brighter

Dimming darker

Dim brighter/darker with start brighter

Dim brighter/darker with start darker

Parameter “Dimming mode”

This parameter defines the dimming mode is start-stop dimming or steps dimming.

Options: Start-stop dimming

Steps dimming

If “Start-stop dimming” is selected, the dimming mode is start-stop dimming; it begins the dimming process with a dim darker or brighter telegram and ends the dimming process with a stop telegram. Cyclical sending of the dimming telegram is not required in this case.

If “Step dimming” is selected, the dimming mode is step dimming, the dimming telegram is sent cyclically during a long operation. Once the operation has finished, a stop telegram ends the dimming process.

Parameter “Brightness change on every sent”

This parameter is only visible for “Dimming steps”. It can be set, which change in brightness (percentage value) causes a dimming telegram to be sent cyclically.

Options: 100%

50%

.....

1.56%

Parameter “Interval of Tele. Cyclic send”

This parameter is only visible for “Dimming steps”. It is able to set the interval of telegram cyclic sending after a long operation.

Options: 0.3s

0.5s

.....

10s

Parameter “Debounce time”

It can set the vibration time to prevent unwanted multiple operation by bouncing of contacts in vibration time, that means the effective time of the contact operation.

Options: 10ms

20ms

.....

150ms

Min. operation

A minimum operation time can only be set if the value “Only dimming” has been set in the parameter “Dimming functionality”. The parameter window will be shown in Fig. 3.

4.2.4 Parameter window “Value/force output, X”

Parameter window “Value/force output , X” will be shown in Fig. 6 and Fig. 7, in Fig. 6 there is a distinction between a short and long operation while in Fig.7 is just opposite.

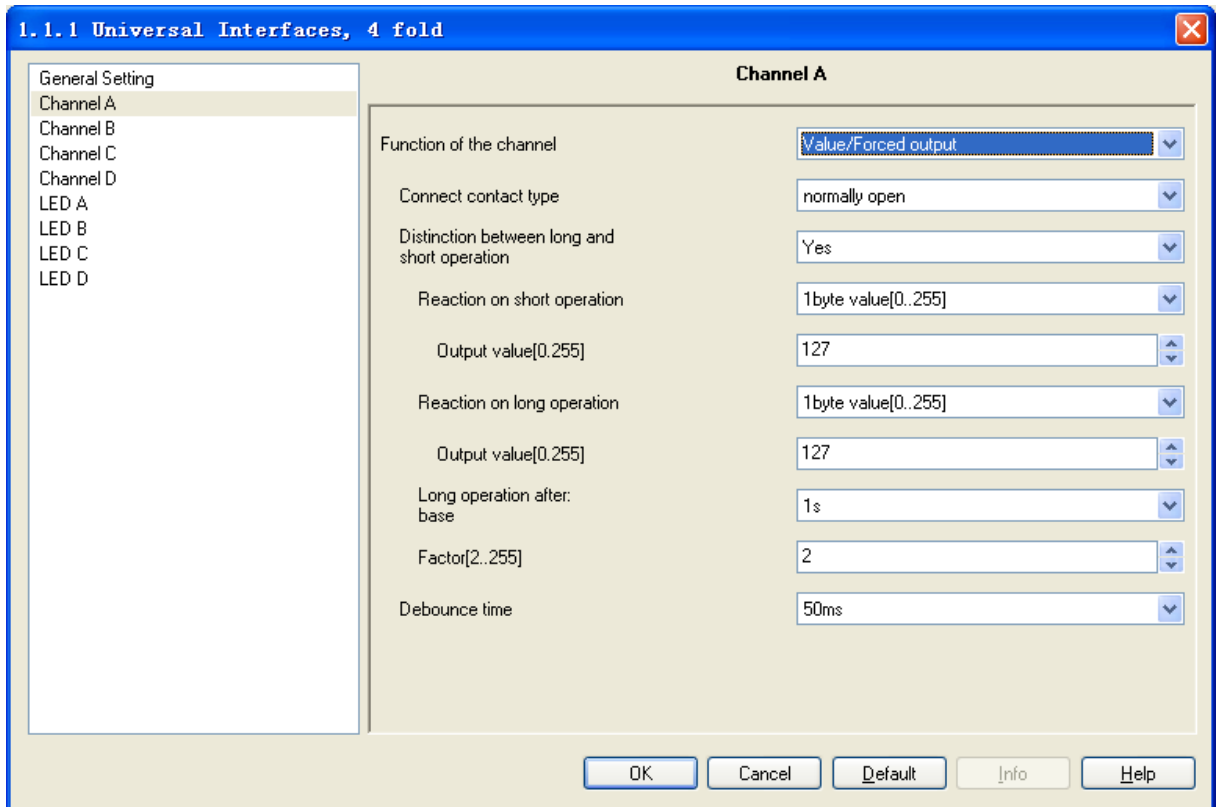

Fig. 6 Parameter window “Value/force output, X” (distinguish with a short and long operation)

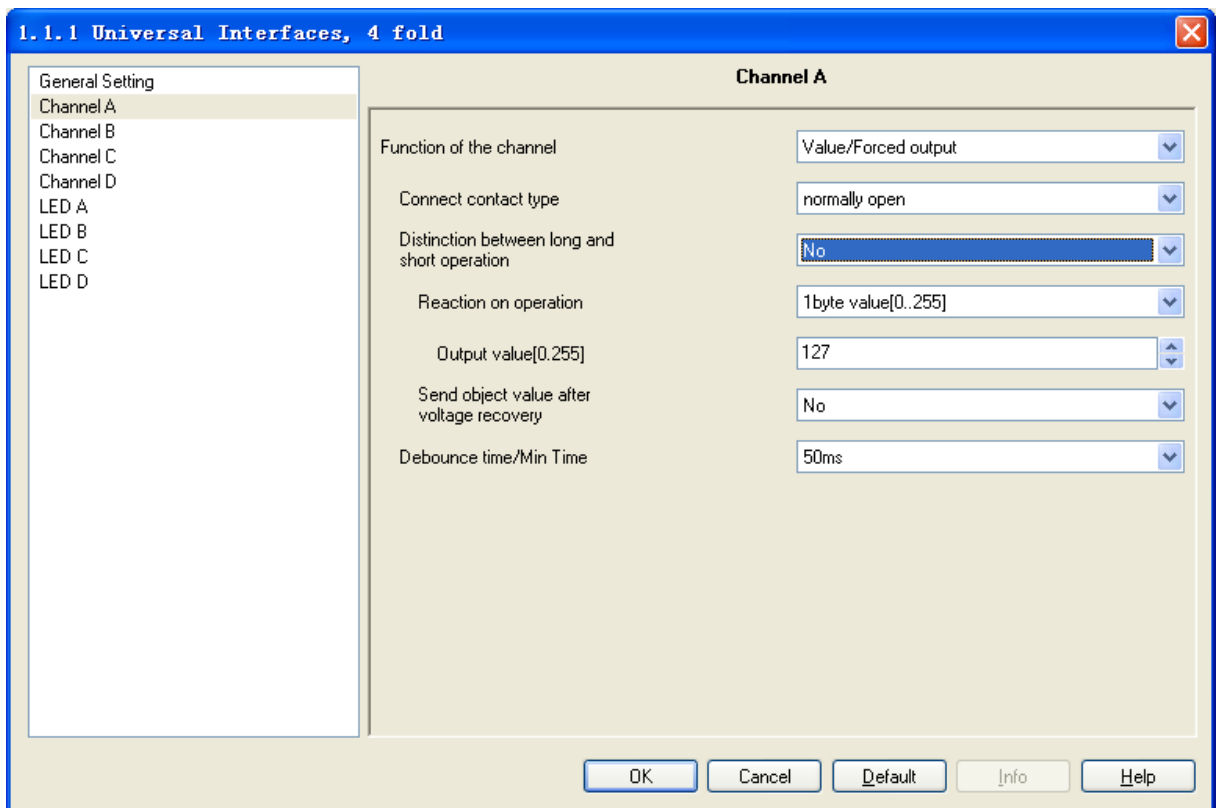

Fig. 7 Parameter window “Value/force output, X” (do not distinguish with a short and long operation)

Parameter “Connect contact type”

This parameter defines whether the contact at the input is a normally open contact or a

normally closed contact.

Options: Normally open
Normally closed

The parameter introduced in this chapter is use “Normally open” as the example; the normally close is just opposite.

Parameter “Distinction between long and short operation”

This parameter sets whether the input distinguishes between a short and long operation. If “yes” is selected, there is a waiting period after the opening/closing of the contact to determine whether the operation is long or short.

Options: Yes
No

Parameter “Reaction on operation”

This parameter is visible if there is no distinction between a short and a long operation. It defines the data type that is sent when the contact is pressed.

Options: No reaction
1 bit value [0, 1]
.....
4 byte value [0...4294967295]

Parameter “Reaction on short operation”/ “Reaction on long operation”

This parameter is visible if there is no distinction between a short and long operation. It defines the data type that is sent after a short or long operation.

Options: 1 bit value [0, 1]
.....
4 byte value [0...4294967295]

Parameter “Output value [...]”

This parameter defines the value which is sent on operation. The value range is dependent on the selected data type. Two values can be set here when there is a distinction between a short and long operation.

Parameter “Long operation after: Base× Factor [0...255]

This parameter is visible if there is a distinction between a short and long operation. The period TL is defined here, after which an operation is interpreted as “long”. TL = Base x Factor.

Base options: 100s
1s
.....
1h
Factor options:2~255

Parameter “Send object value after voltage recovery”

This parameter defines whether to send object value of “Tele. Value, X” on the bus after the voltage recovery. This parameter is visible if there is no distinction between a short and long operation. If “yes” is selected, the device sends the object “Tele. Value, X” on the bus after bus voltage recovery.

Options: Yes
No

Parameter “Debounce time”

It can set the vibration time to prevent unwanted multiple operation by bouncing of contacts in vibration time, which means the effective time of the contact operation.

- Options: 10ms
- 20ms
-
- 150ms
- Min. operation

A minimum operation time can only be set if there is no distinction between a short and long operation. The parameter window will be shown in Fig. 3.

4.2.5 Parameter window “Scene control, X”

Parameter window “Scene control, X” will be shown in Fig. 8, it will be visible when the function channel “Scene control” is selected. This function enables the states of several actuator groups to be recalled and stored.

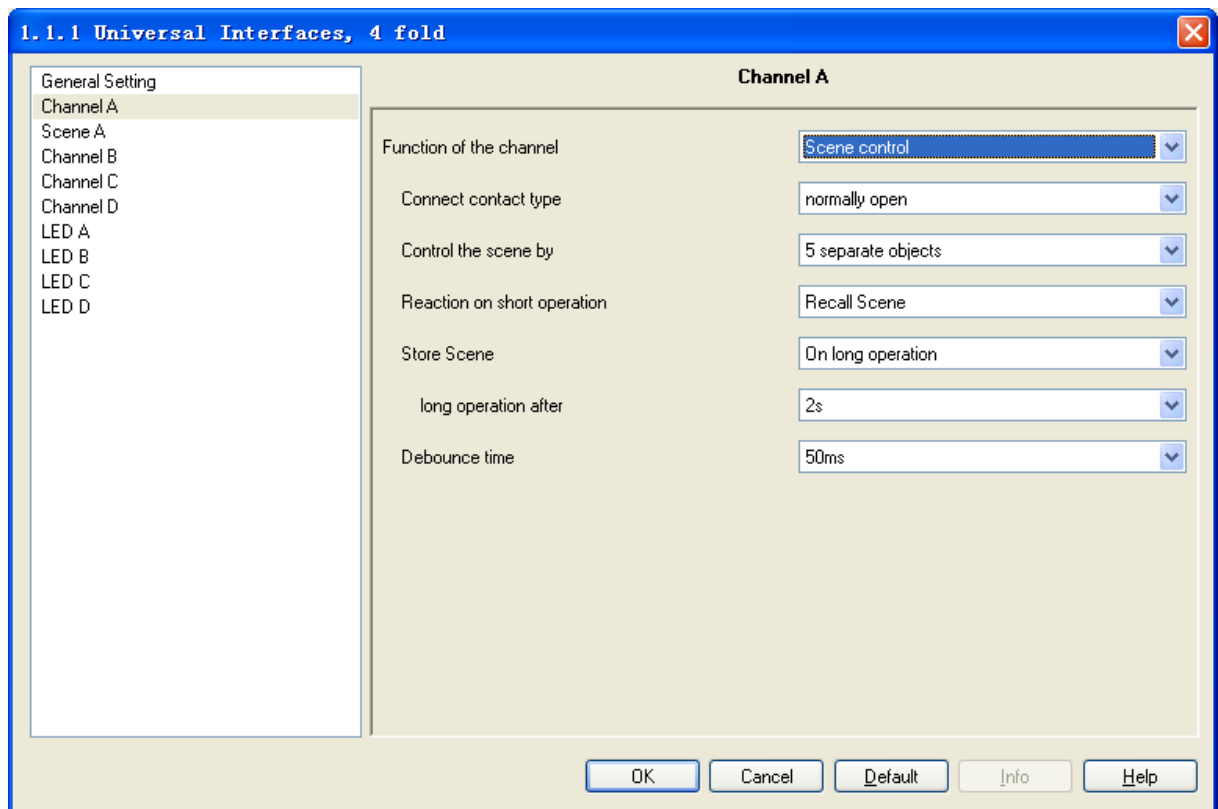

Fig. 8 Parameter window “Scene control, X”

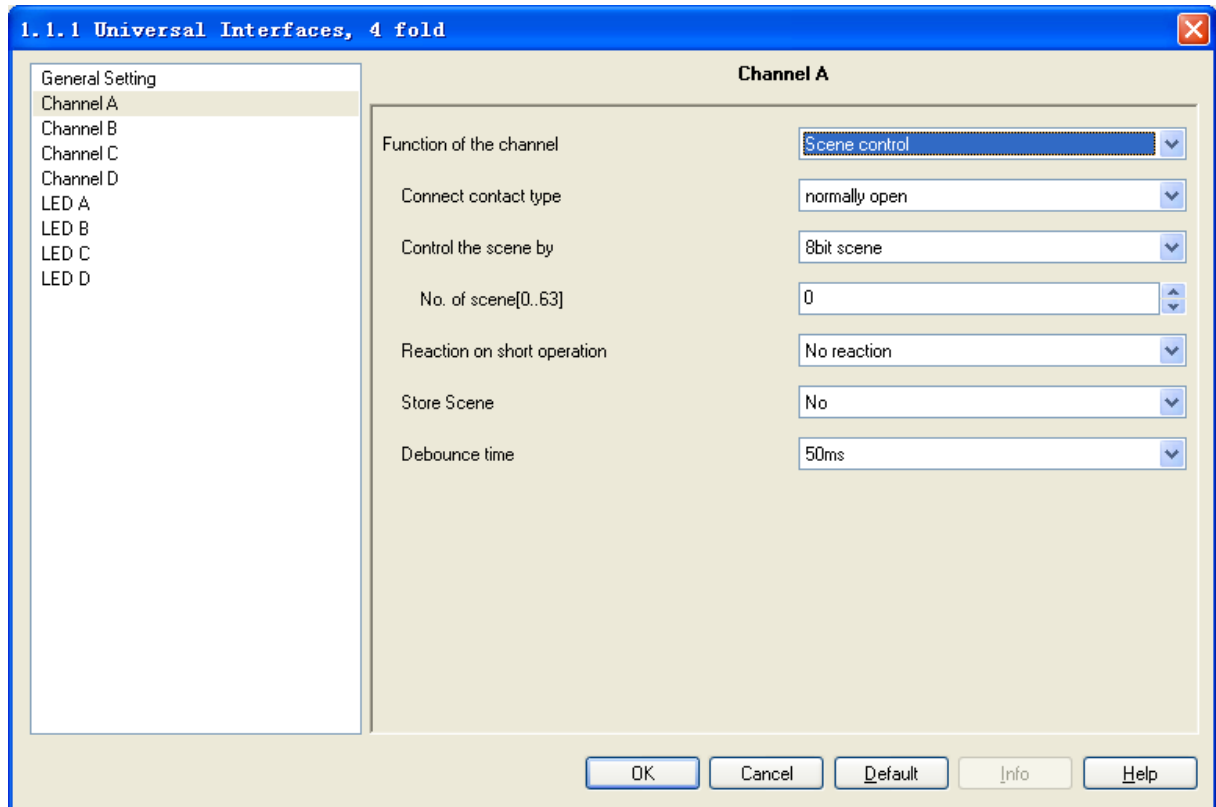

Fig. 9 Parameter window “8 bit scene”

Parameter “Connect contact type”

This parameter defines whether the contact at the input is a normally open contact or a normally closed contact.

Options: Normally open
Normally closed

The parameter introduced in this chapter is use “Normally open” as the example, the normally close is just opposite.

Parameter “Control the scene by”

It is possible to select whether the scene control is carried out via “5 separate objects” or whether values that are stored in the actuators are recalled and saved via an “8 bit scene”.

Options: 5 separate objects
8 bit scene

If the parameter “5separate objects” is selected, it will activate the control of the groups of the actuator, these 5 objects’ parameter window will be shown in Fig. 10; If the parameter “8 bit scene” is selected, it can control the scene such as the scene function in dimming actuator、 switch actuator, the parameter window will be shown in Fig. 9.

Parameter “No. of scene [0..63]”

This parameter will be visible when the scene control is “8 bit scene”, it can be set the No. of scene. The No. range is 0~63.

Parameter “Reaction on short operation”

This parameter defines whether a short operation of the input causes a light scene to be recalled or no reaction takes place.

Options: No reaction

Recall scene

Parameter “Store scene”

This parameter defines how the saving of the current scene.

Options: No

On long operation

With object value= ‘1’

On long operation and object value= ‘1’

Different type of scene control makes the saving of the current scene different. The following table provides an overview:

Control the scene via “5 separate objects”:

Parameter value	Behaviour
On long operation	<p>As soon as a long operation is detected, the object “Store scene, X” sends the value “1” on the bus and the object “Output 1bit/8bit, group A...E” send read out telegram. The objects “Output 1bit/8bit, group A...E” can be modified via the bus for the duration of the long operation.</p> <p>Once the long operation has finished, the object “Store scene, X” sends the value “0” on the bus and the current object values can’t be modified</p> <p>On the long operation, If the object “Store scene, X” receives the value “0” on the bus, even the long operation has not finished ,the current object value also can’t be modified</p>
If object value= ‘1’	<p>If the object “Store scene, X” receives the value “1”, the object values “Output 1bit/8bit, group A...E” are read out via the bus. While the object value is “1”, the objects “Output 1bit/8bit, group A...E” can be modified via the bus.</p> <p>On receipt of the object value “0”, the current object values can’t be modified</p>
On long operation and object value= ‘1’	<p>If the object “Store scene, X” receives the value “1” on the bus, on the next long operation, the object “Output 1bit/8bit, group A...E” read out the telegram. The objects “Output 1bit/8bit, group A...E” can be modified via the bus for the duration of the long operation. After the end of the long operation, the object values can’t be modified, the object “store scene, X” will send value ‘0’</p>

	<p>On the long operation, If the object “Store scene, X” receives the value “0” on the bus, even the long operation has not finished ,the current object value also can’t be modified</p> <p>Provided that a “1” has not been received at the object “Store scene, X”, a long operation is interpreted in the same way as a short operation.</p>
--	--

Control the scene via “8 bit scene”:

Parameter value	Behaviour
On long operation	After a long operation, the object “8 bit scene” sends a save command on the bus and thereby triggers the storing of the current scene in the actuators e.g. dimming actuator, switch actuator.
If object value= ‘1’	If the object “Store scene, X” receives the value “1”, the object “8 bit scene” sends a save command on the bus and save the current scene.
On long operation and object value= ‘1’	<p>If the object “Store scene, X” receives the value “1” on the bus, the next long push button action triggers the sending of a save command via the object “8 bit scene”, the current scene will be saved. When the object “store scene, X” receives the value “0”, end up the saving the value of current scene.</p> <p>Provided that a “1” has not been received at the object “Store scene” since the last save, a long operation is interpreted in the same way as a short operation.</p>

Parameter “Long operation after”

This parameter is visible when the parameter “Store scene” is “On long operation” or “On long operation and object value= ‘1’”, it defines the period here, after which an operation is interpreted as “long”.

- Options: 0.3s
- 0.5s
-
- 10s

Parameter “Debounce time”

It can set the vibration time to prevent unwanted multiple operation by bouncing of contacts in vibration time, that means the effective time of the contact operation.

- Options: 10ms
- 20ms

.....
150ms

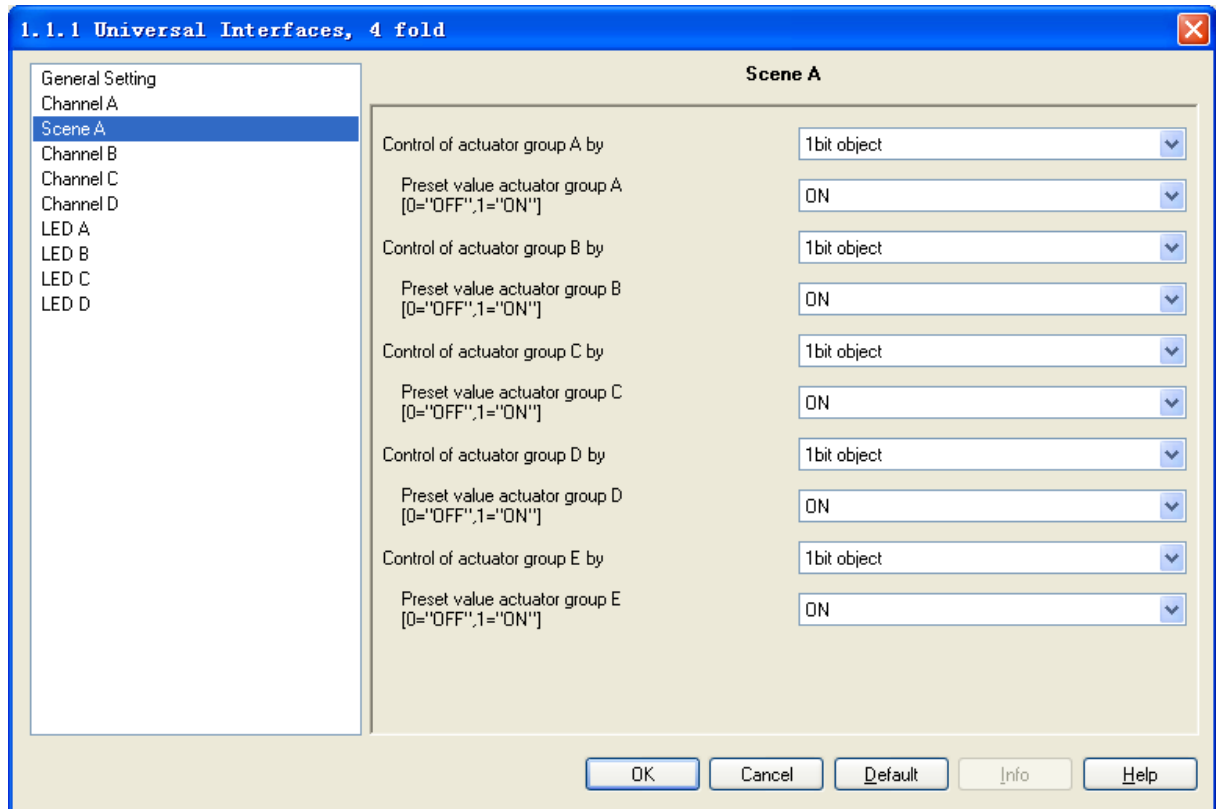

Fig. 10 Parameter window “Scene X”

Parameter window “Scene X”

The parameter window “Scene X” will be shown in Fig. 10, it is visible if the control of the light scenes is carried out via “5 separate objects”.

Parameter “Control of actuator group A...E”

It can be set for each actuator group whether the control is carried out via a “1 bit object” or an “8 bit object”.

Options: 1 bit object
8 bit object

Parameter “Preset value actuator group A...E”

This parameter set the preset value of the actuator group. This value can be modified via the bus when save the scene. If the bus voltage recovery this value will be modified as preset value.

4.2.6 Parameter window “Switching sequence, X”

The parameter window “Switching sequence” will be shown in Fig. 11. It is visible if the input is operated with the function “Switching sequence”. A switching sequence enables the stepwise modification of several values via a single operation.

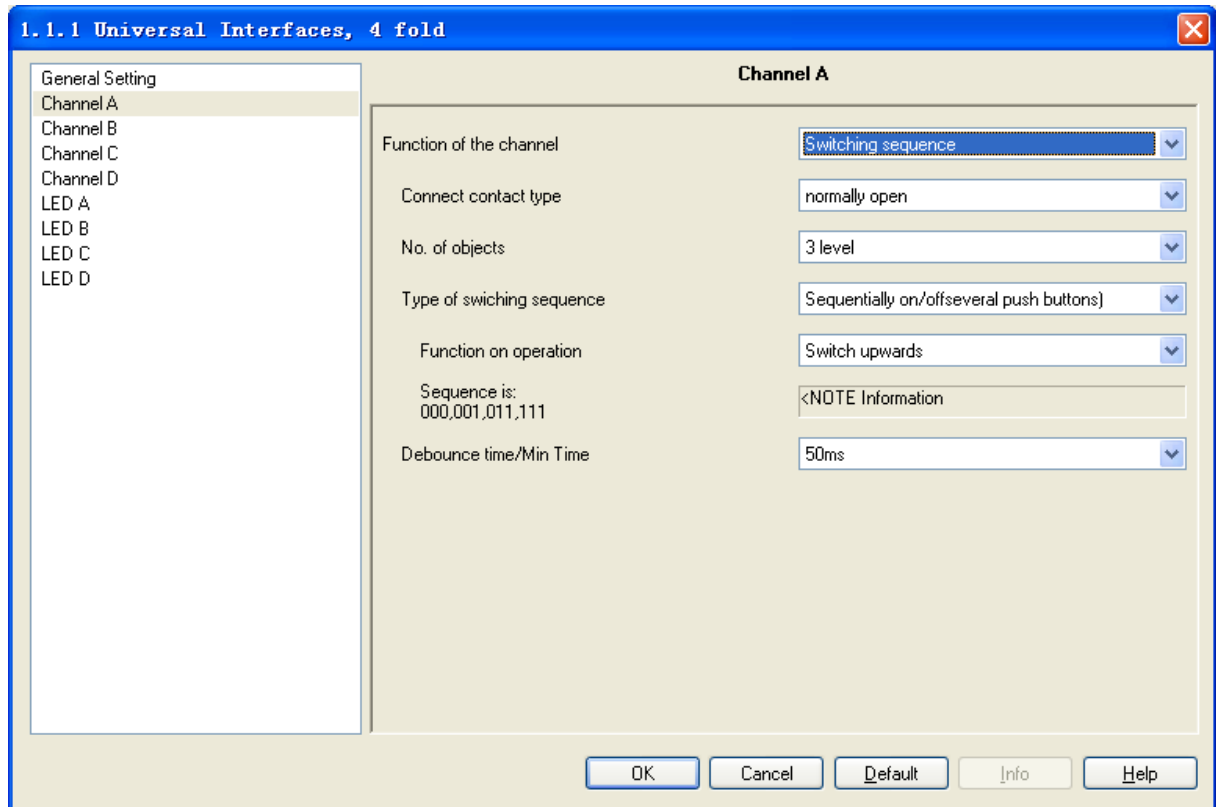

Fig.11 Parameter window “switching sequence, X”

Parameter “Connect contact type”

This parameter defines whether the contact at the input is a normally open contact or a normally closed contact.

- Options: Normally open
- Normally closed

The parameter introduced in this chapter is use “Normally open” as the example, the normally close is just opposite.

Parameter “No. of objects”

This parameter defines the number of objects, which is the number of levels, it is identical to the number of communication objects.

- Options: 2level
- 3level
- 4level
- 5level

For example, parameter “3level” means there are 3 communication objects: “level-1”, “level-2”, “level-3”. The first operation modified the value of “level-1”, the second operation modified the value of “level-2”, the third operation modified the value of “level-3”, the fourth from modified the value of “level-3”....., the switch sequence is: 000,001,011,111,011.....The data send on the bus is the value of the communication object that after modified, which is the alterative data. The communication object “level increment/decrement, X” is used to increase or decrease the switch level, ‘1’ means increase 1 level and ‘0’ means decrease.

Different options have different communication objects and different switch levels, but their management are similar in the case of the same switch sequence type.

Parameter “Type of switching sequence”

The switching sequence can be selected here. Each sequence has other object values for each switching level.

- Options: Sequentially on/off (one push button)
- Sequentially on/off (several push buttons)
- All combinations

Take “3level” as the example to explain the difference between them (send the modified data on the bus, data “0”= OFF, “1”=ON):

Type of switching sequence	Example
Sequentially on/off (one push button)	...-000-001-011-111-011-001-...
Sequentially on/off (several push buttons)	000-001-011-111or 111-011-001-000
All combinations	...-000-001-011-010-110-111-101-100-... (Gray code)

Parameter “Function on operation”

Only visible in the switching sequence “Sequentially on/off (several push buttons)”. It can be set whether an operation of the push button switches up or down a level.

- Options: Switch upwards
- Switch downwards

The implement direction of the parameter “Switch upwards” is “000-001-011-111”, the implement direction of the parameter “Switch downwards” is “111-011-001-000”.After the bus voltage recovery, the current value is 000, if the parameter “Switch downwards” is selected, the effect will be invisible when operation, then it is possible to operation after switch up a few levels by the object “level increment/decrement, X”.

Parameter “Sequence is ...”

This parameter indicate the manage process when there are different type of switching sequence.

Parameter “Debounce time/Min. Time”

It can set the vibration time to prevent unwanted multiple operation by bouncing of contacts in vibration time, which means the effective time of the contact operation.

- Options: 10ms
- 20ms
-
- 150ms
- Min. operation

The parameter window “Min. operation” will be shown in Fig. 3.

4.2.7 Parameter window “Counter, X”

The parameter window “Counter, X” will be shown in Fig. 12. It is visible when the input is operated with the function “Counter”.

Using the “Counter” function, the device is able to count the number of pulse edges at the input. A “differential counter” is therefore available if required in addition to the standard counter. Both counters are triggered by counting pulses but otherwise operate independently of each other. The counter always has the same data width as the differential counter.

The function is similar with the differential counter and the standard counter. The different is

the differential counter can reset the counter value (count from 0) and overflow by the bus counter report.

Attention: When disable the function, both key scanning and object in/out are disabled. Any key status change will be ignored.

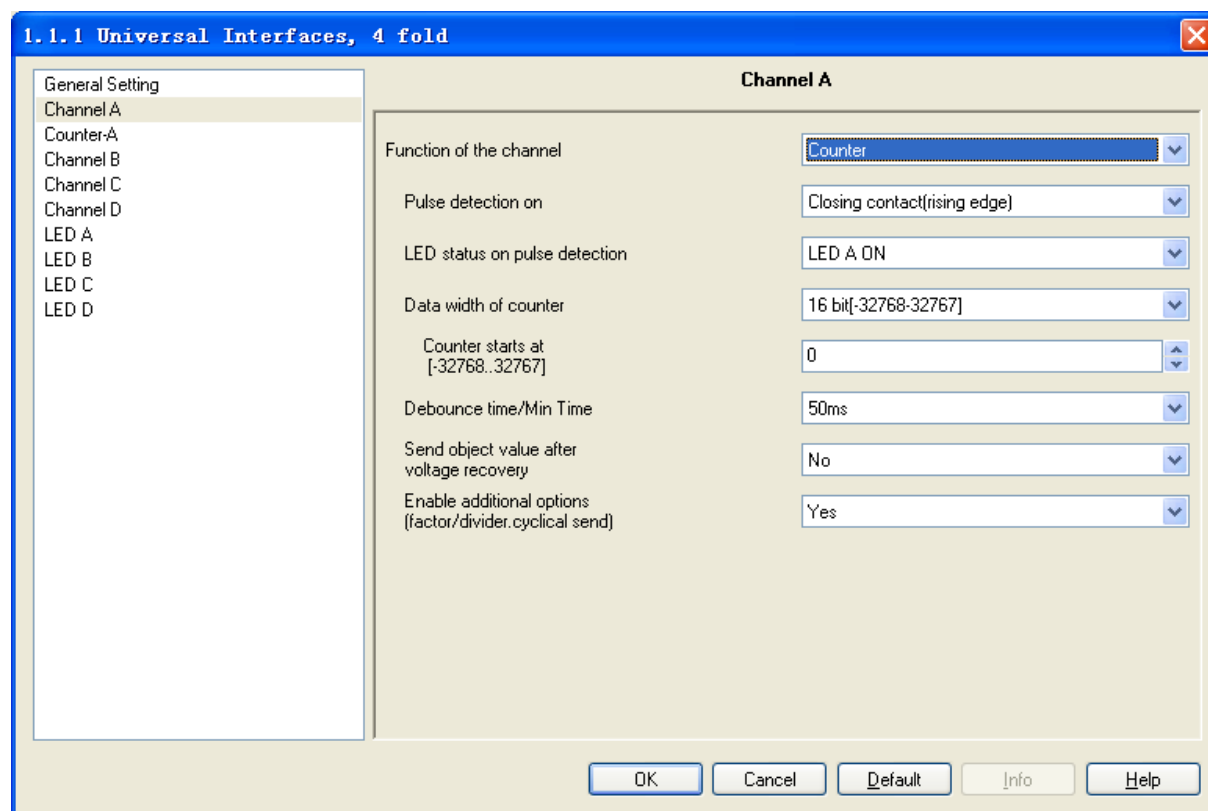

Fig.12 Parameter window “Counter, X”

Parameter “Pulse detection on”

The type of input signal is defined in this parameter. It can be set whether the contact is a normally open contact (pulse trailing edge) or a normally closed contact (pulse rising edge).

- Options: Closing contact (rising edge)
- Opening contact (falling edge)

The parameter introduced in this chapter is use “Closing contact (rising edge)” as the example, the operation of opening contact is just opposite.

Parameter “LED status on pulse detection”

This parameter defines the indication of LED, whether to be on, off or no action when detect there is pulse input.

- Options: LED A ON
- LED A OFF
-
- DED D OFF
- No action

Note: If the four channels invoke the same option, the priority of channel A is the highest, it will carry out the preset operation when detected pulse input. Then the priority of channel B is higher, then it’s C, the last is D. The priority of LED X in function channel in the device is higher than the LED X channel, the LED X can not be implement any operation in channel LED X which

is used in the function channel in the device. If the parameter “LED status on pulse detection” is set “LED A ON” or “LED A OFF” options, the operation had been set in LED A can not be carry out.

Parameter “Date width of counter”

The data type of the counter (absolute counter and differential counter) is defined in this parameter. The data type specifies the counting range for the counter.

The type of the objects “Output counter value.....” and “Differential counter ...” is adapted to the data type of the parameter setting.

- Options: 8bit [0...255]
- 16bit [-32768...32767]
- 16bit [0...65535]
- 32bit [-2147483648...2147483647]

Parameter “Counter starts at”

The starting value of the absolute counter is defined in this parameter. When the bus power on, it will calculate the new counter value from this preset starting value.

Parameter “Debounce time”

It can set the vibration time to prevent unwanted multiple operation by bouncing of contacts in vibration time, which means the effective time of the contact operation.

- Options: 10ms
- 20ms
-
- 150ms
- Min. operation

The parameter window “Min. operation” will be shown in Fig. 3.

Parameter “Send object value after voltage recovery”

This parameter defines whether to send the current value when the bus voltage recovery. If the differential counter has been enabled, it is also sent on the bus and it is reset to zero. If the bus voltage failure, the standard counter and the differential counter are reset to the starting value, the standard counter will calculate from the preset starting value.

- Options: Yes
- No

Parameter “Enable additional options (factor/divider. Cyclical send)”

Additional functions are possible here. If this parameter is set to “yes”, the parameter window Fig.13 is displayed.

- Options: Yes
- No

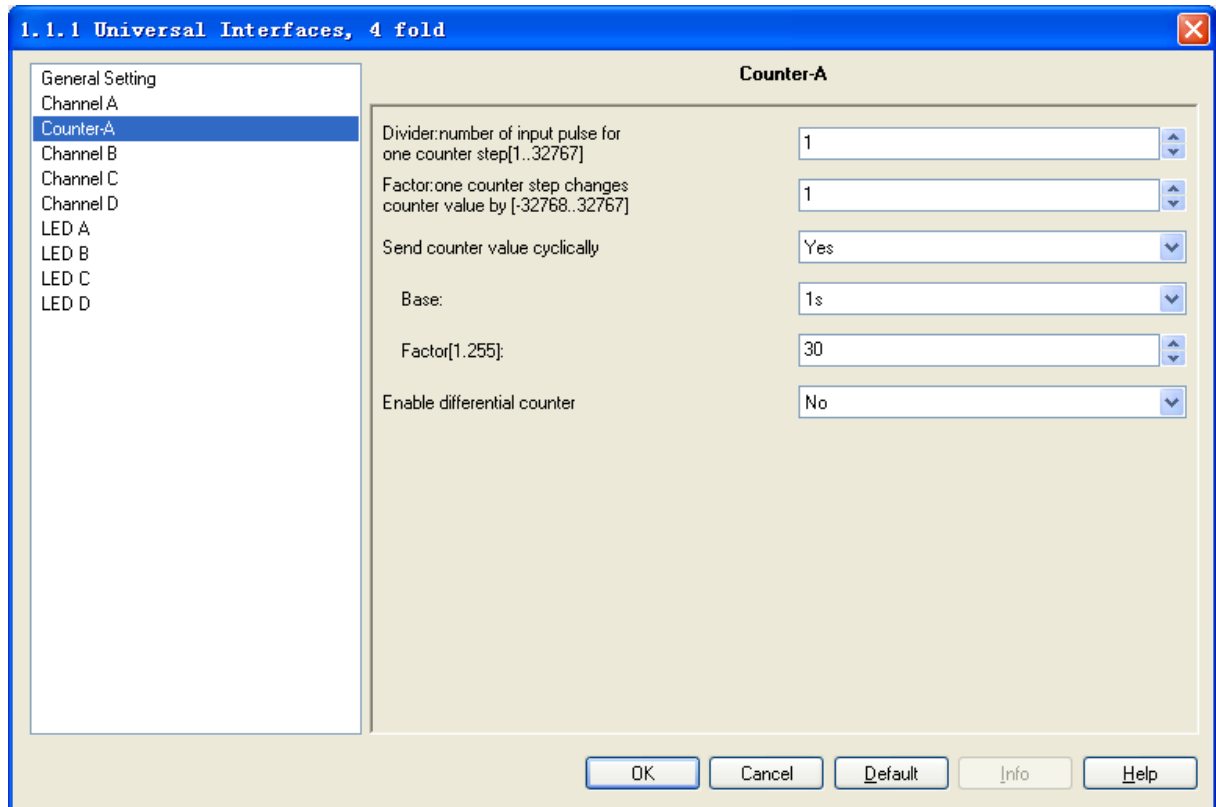

Fig.13 Parameter window “Counter-X”

Parameter “Divider: number of input pulse for one counter step[1...32767]”

It can be set via this parameter how many pulses are necessary to generate a counting pulse. The range of pulse importability: 1...32767.

Parameter “Factor: one counter step changes counter value by [-32768...32767]”

This parameter defines how much the counter and differential counter should be increased by in the event of a counting pulse. Range:-32768...32767

Parameter “Send counter value cyclically”

This parameter defines whether to send the current value cyclically. If this parameter has the value “yes”, the values of the counter and the differential counter are sent cyclically on the bus.

- Options: Yes
- No

Parameter “Base”/ “Factor [1...255]”

It is visible if the parameter “Send counter value cyclically” is “Yes”. This parameter is used to set the interval time between two telegrams that are sent cyclically, Transmission cycle time =Base × Factor.

- Base options: 1s
- 10s
- ...
- 1h

Factor options: 1...255

Parameter “Enable different counter”

This parameter defines whether to enable the differential counter function, if “Yes” is selected, it will enable.

Options: Yes

No

Parameter “Over-/under run of differential at [...]”

This parameter is visible if the parameter “Enable differential counter” is set to “yes”.

It can be set in this parameter which value generates an overflow of the differential counter. The overflow object will send a overflow value “1” on the bus when in the event of an overflow.

4.2.8 Parameter window “Multiple operation, X”

The parameter window “Multiple operation, X” will be shown in Fig.14. It is visible if the input is operated with the function “Multiple operation”. Enable the function, if the input is operated several times within a certain period, a specified object value can be modified depending on the number of operations. This enables e.g. different light scenes to be implemented with multiple push button actions.

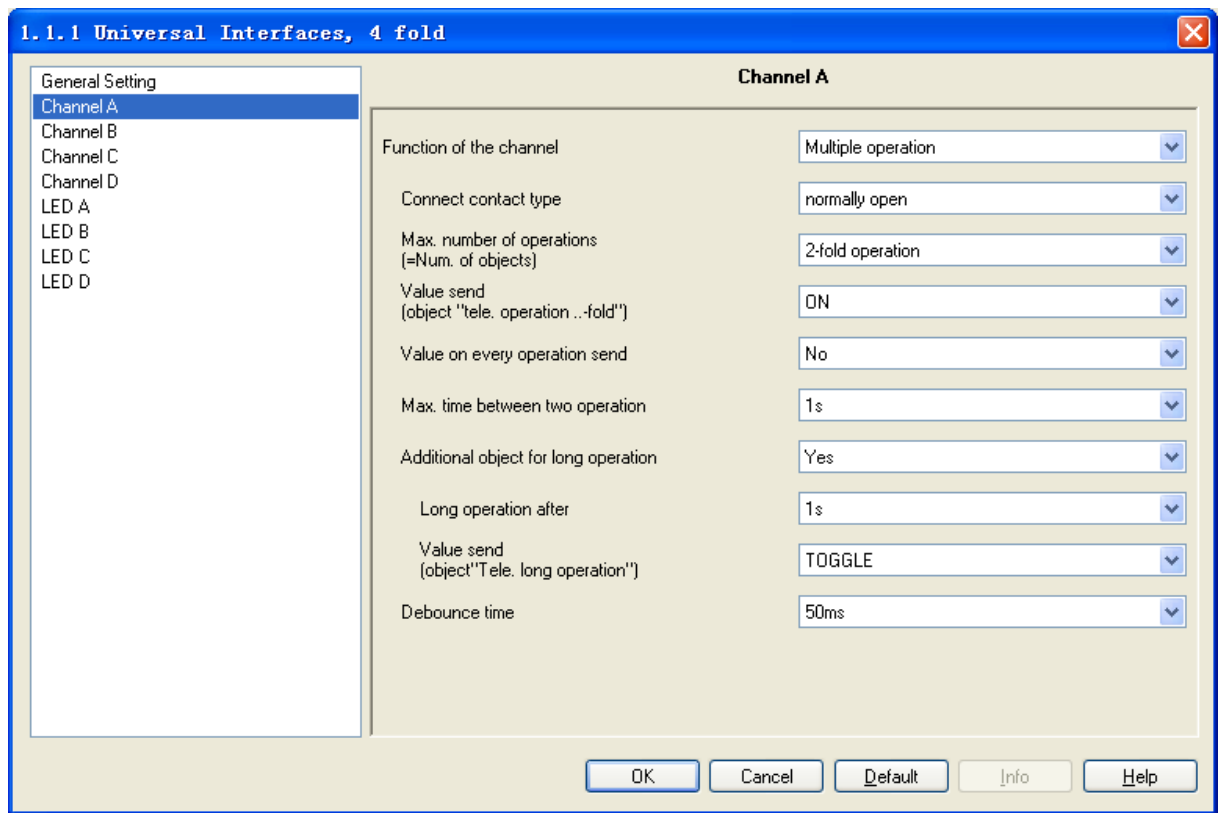

Fig.14 Parameter window “Multiple operation”

Parameter “Connect contact type”

This parameter defines whether the contact at the input is a normally open contact or a normally closed contact.

Options: Normally open

Normally closed

The parameter introduced in this chapter is use “Normally open” as the example, the normally close is just opposite.

Parameter “Max. number of operations [=Num. of objects]”

This parameter specifies the maximum permitted number of operations. This number is identical to the number of communication objects “Output X-fold”.

Options: Single operation

2-fold operation

3-fold operation

4-fold operation

Parameter “Value send (object “Tele. Operation ...-fold)”

It can be set here which object value should be sent.

Options: On

Off

Toggle

The current object value is inverted in the “Toggle” setting.

Parameter “Value on every operation send”

This parameter defines whether to send the operation value.

Options: Yes

No

If “yes” is entered in this parameter, the associated object value is updated and sent after each operation in the case of multiple push button actions. Example: For three-fold operations, the objects “output 1-fold” (after the first operation), “output 2-fold” (after the second operation) and “output 3-fold” (after the third operation) are sent. If “No” is selected, the current value will be send on the bus until the last operation delay (the delay time is the interval time between two operations).

Parameter “Max. time between two operation”

This parameter sets the interval between two operations. If there are no further operations within this period, the object “output 1-fold” is sent again.

Options: 0.3s

0.5s

...

10s

Parameter “Additional object for long operation”

This parameter defines whether to activate the long operation. If a long operation is carried out after one or several short operations within the maximum period, the short operations are ignored.

Options: Yes

No

Parameter “Long operation after”

This parameter is visible if long operation activate. The period is defined here, after which an operation is interpreted as “long”.

Options: 0.3s

0.5s

...

10s

Parameter “Value send (object “Tele. Long Operation)”

This parameter is visible if long operation activate. This parameter defines the value sent by the object “output long-fold” on the bus when it is set long operation.

Options: On

Off

Toggle

The current object value is inverted in the “Toggle” setting.

Parameter “Debounce time”

It can set the vibration time to prevent unwanted multiple operation by bouncing of contacts in vibration time, which means the effective time of the contact operation.

Options: 10ms
20ms
.....
150ms

4.2.9 Parameter window “Shutter control, X”

The parameter window “Shutter control, X” will be shown in Fig.15. It is visible if the channel function “Shutter control” is selected. When enable this function, it is possible to control the shutter by one button/switch or two button/switch operation.

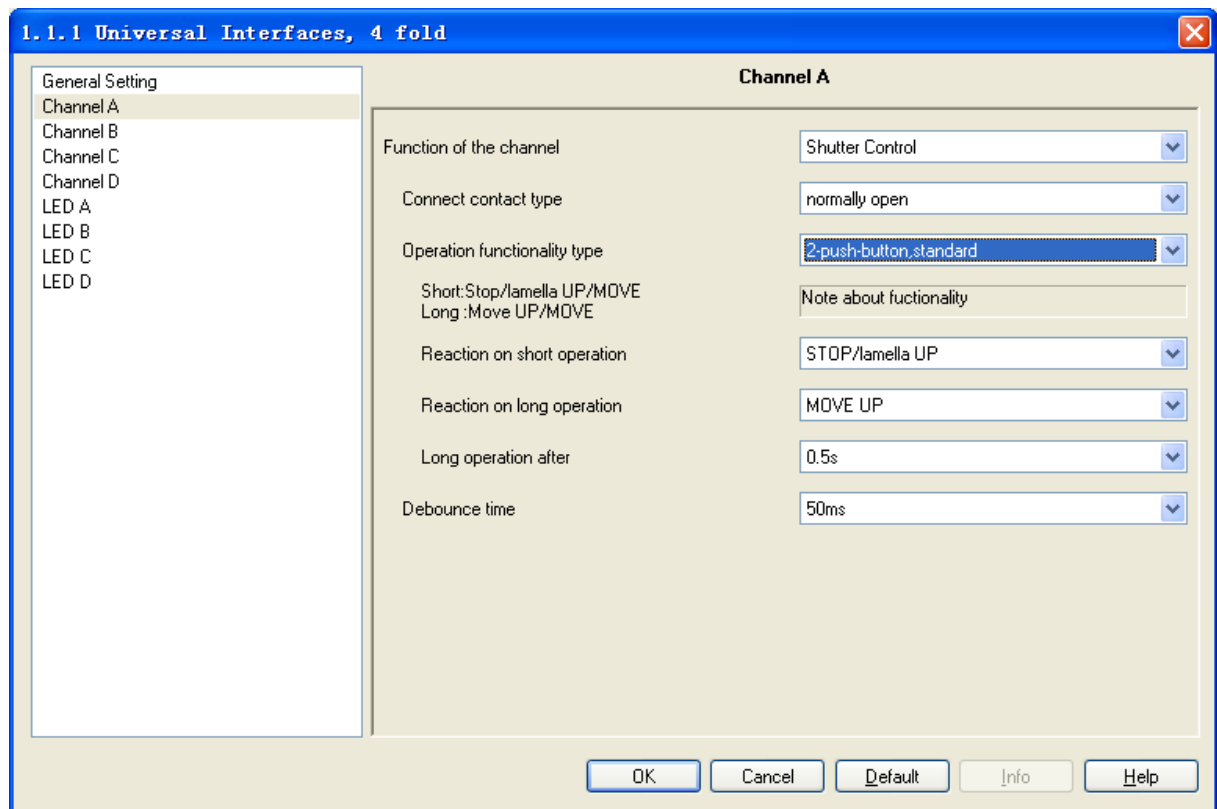

Fig.15 Parameter window “Shutter control, X”

Parameter “Connect contact type”

This parameter defines whether the contact at the input is a normally open contact or a normally closed contact.

Options: Normally open
Normally closed

The parameter introduced in this chapter is use “Normally open” as the example, the normally close is just opposite.

Parameter “Operation functionality type”

This parameter defines the types of the shutters operation, detailed description of the type and function as the following table:

1-push-button,short=stepping, long=moving	
Short operation	Alternate implement “Stop/Adjust upward” or “Stop/Adjust downward” operation (alternate send the value of the object “0”and“1”)
Long operation	Alternate implement “Move up” or “Move down” operation (alternate send the value of the object “0”and“1”)
1-push-button, short=moving, long=stepping	
Short operation	Alternate implement “Move up” or “Move down” operation (alternate send the value of the object “0”and“1”)
Long operation	Alternate implement “Stop/Adjust upward” or “Stop/Adjust downward” operation (alternate send the value of the object “0”and“1”)
1-push-button-operation, moving	
Operation	When operation, send the command in sequence: —>Move up —>Stop/Adjust upward —>Move down —>Stop/Adjust downward—>.....
1-switch-operation, moving	
Operation start (press the button)	Alternate implement “Move up” or “Move down” operation (alternate send the value of the object “0”and“1”)
Operation end (Release the button)	Stop/Adjust
2-push-button, standard	
Short operation	“Stop/Adjust upward” or “Stop/Adjust downward” (set by parameter)
Long operation	“Move up” or “Move down” (set by parameter)
2-push-button, moving[shutter]	
Operation	When operation, send the command in sequence: —>Move up—>Stop/Adjust upward—>.....or —>Move down—>Stop/Adjust downward—>..... (Move up/down set by parameter)
2-push-button, stepping	
Operation	“Stop/ Adjust upward” or “Stop/ Adjust downward” (set by parameter) (keep pressing the button can send cyclic)
2-switch-operation, moving[shutter]	
Operation start	“Move up” or “Move down” (set by parameter)
Operation end	“Stop / Adjust upward” or “Stop / Adjust downward” (the sending value is identical to the value that the operation starting)

Parameter ““ Tele. STOP/adjust adj.” Cyclical send”

It is visible if the shutter control type is “1-push-button, short=moving, long=stepping”and“2-push-button, stepping”. It is able to set the interval time of sending the object “stop/adjust adj.” cyclical.

Options: 0.3s
0.5s
...
10s

Parameter “Reaction on short operation”

It is visible if the shutter control type is “2-push-button, standard”. This parameter defines the operation with short operation.

Options: Stop/adjust up
Stop/adjust down

Parameter “Reaction on long operation”

It is visible if the shutter control type is “2-push-button, standard”. This parameter defines the operation with long operation.

Options: Move up
Move down

Parameter “Reaction on operation”

It is visible if the shutter control type is “2-push-button, moving[shutter]” , “2-switch-operation, moving[shutter]” and “2-push-button, stepping”. It defines the action when operation. Different control type makes different operate action. The former two control type is move up and down; the last control type is stop reaction.

Options: Move up
Move down
Options: Stop/adjust up
Stop/adjust down

Parameter “Long operation after”

This parameter is visible if long operation activate. The period is defined here, after which an operation is interpreted as “long”.

Options: 0.3s
0.5s
...
10s

Parameter “Debounce time”

It can set the vibration time to prevent unwanted multiple operation by bouncing of contacts in vibration time, which means the effective time of the contact operation.

Options: 10ms
20ms
.....
150ms

4.3 Description of setting the system parameter in part of LED channel

The LED priority in the channel LED part is lower than the LED in device channel. When enable the LED setting in device channel, the LED in LED channel will not action.

4.3.1 Parameter window “Flashing, X”

The parameter window will be shown in Fig.16. It is able to set the LED flash function and turn on the LED for long time simultaneously.

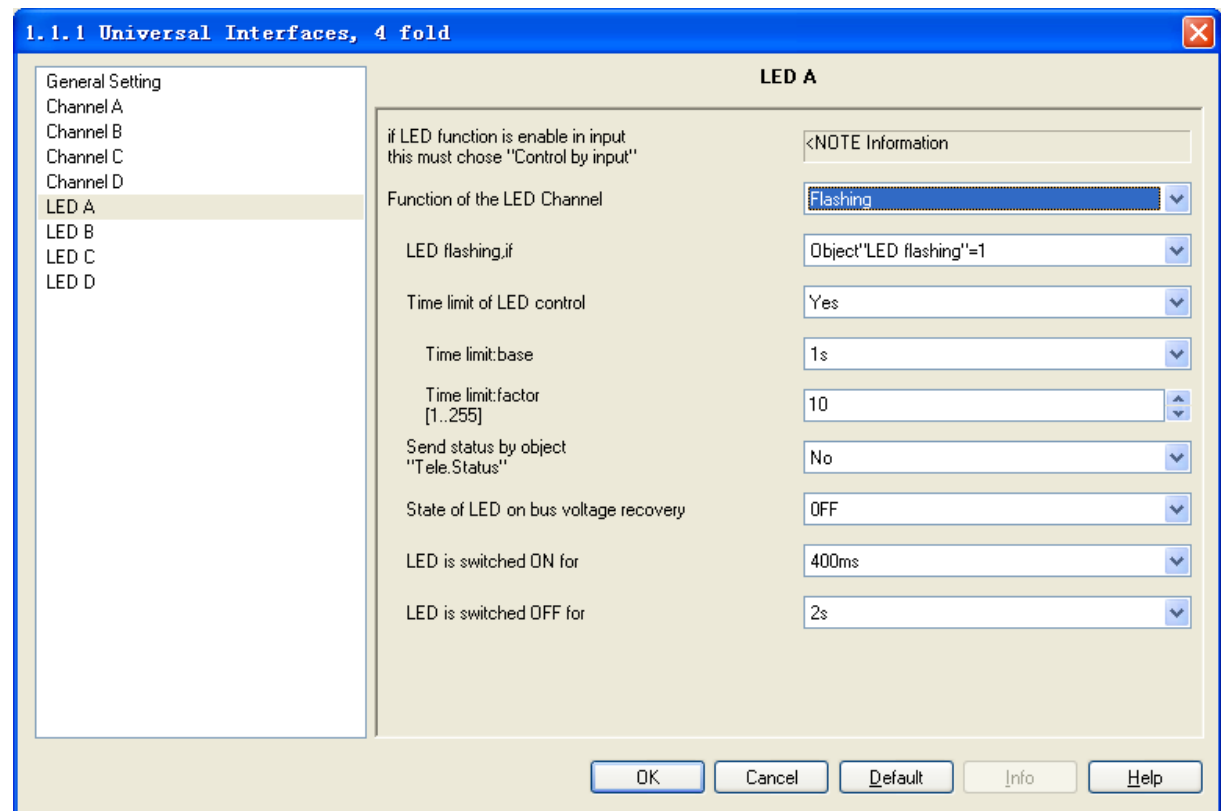

Fig.16 Parameter window “Flashing, X”

Parameter “Function of the LED channel”

This parameter defines the function of the LED channel. The default parameter is “Flashing” function. If “No action” is selected, it means this channel disable.

- Options: No action
Flashing
Switch
Control by input
Indicate object in
Indicate object out
Indicate object in and out

Parameter “LED Flashing, if”

This parameter defines the mode of opening the LED flashing.

- Options: Object “LED flashing”=0
Object “LED flashing”=1

Parameter “Time limit of LED control”

This parameter defines whether to enable the function to restrict the flashing of the LED.

- Options: Yes
No

Parameter “Time limit: Base× Factor

This parameter is visible if the time limit is active. It defines the time of LED flashing:

Base×Factor.

Base options: 1s
10s
...
1h

Factor options: 1...255

Parameter “Send status by object “Tele. Status””

This parameter defines whether to send the LED status report on the bus.

Options: Yes
No

If “Yes” is selected, the object “Send its status, X” will send value “1” when LED flashing; it will send value “0” when LED stop flashing.

Parameter “State of LED on bus voltage recovery”

It is defines the state of LED when the bus voltage recovery.

Options: On
Off

Parameter “LED is switched ON/OFF for”

It is defines the time of the LED switched on/off when LED flashing.

Options: 600ms
800ms
.....
60s

4.3.2 Parameter window “Switch, X”

The parameter window “Switch, X” will be shown in Fig.17 to defines the switch function of LED. The LED will switch off automatic and it can keep switching on after the LED is switch on for a while.

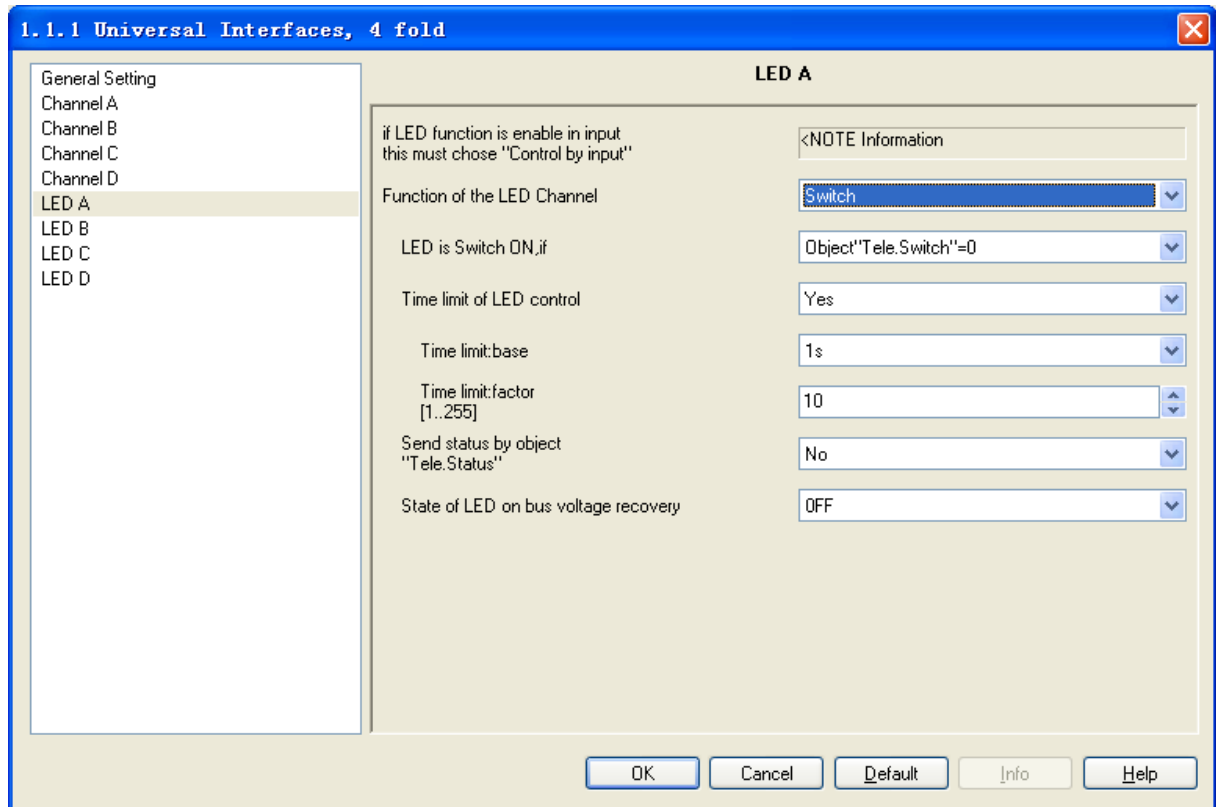

Fig.17 Parameter window “Switch, X”

Parameter “LED is switch ON, if”

This parameter defines the mode to switch on the LED.

- Options: Object “Tele. Switch”=0
- Object “Tele. Switch”=1

Parameter “Time limit of LED control”

This parameter defines whether to enable the function to restrict the time to switch on the LED.

- Options: Yes
- No

Parameter “Time limit: Base× Factor

This parameter is visible if the time limit is active. It is defines the time of LED flashing: Base×Factor. After this period, the LED switches off automatically.

- Base options: 1s
- 10s
- ...
- 1h
- Factor options: 1...255

Parameter “Send status by object “Tele. Status””

This parameter defines whether to send the LED status report on the bus.

- Options: Yes
- No

If “Yes” is selected, the object “Send its status, X” will send value “1” when LED switch on; it will send value “0” when LED switch off.

Parameter “State of LED on bus voltage recovery”

It is defines the state of LED when the bus voltage recovery.

Options: On

Off

4.3.3 Parameter window “Control by input, X”

The parameter window “Control by input, X” will be shown in Fig.18, the LED is used to indicate the button input.

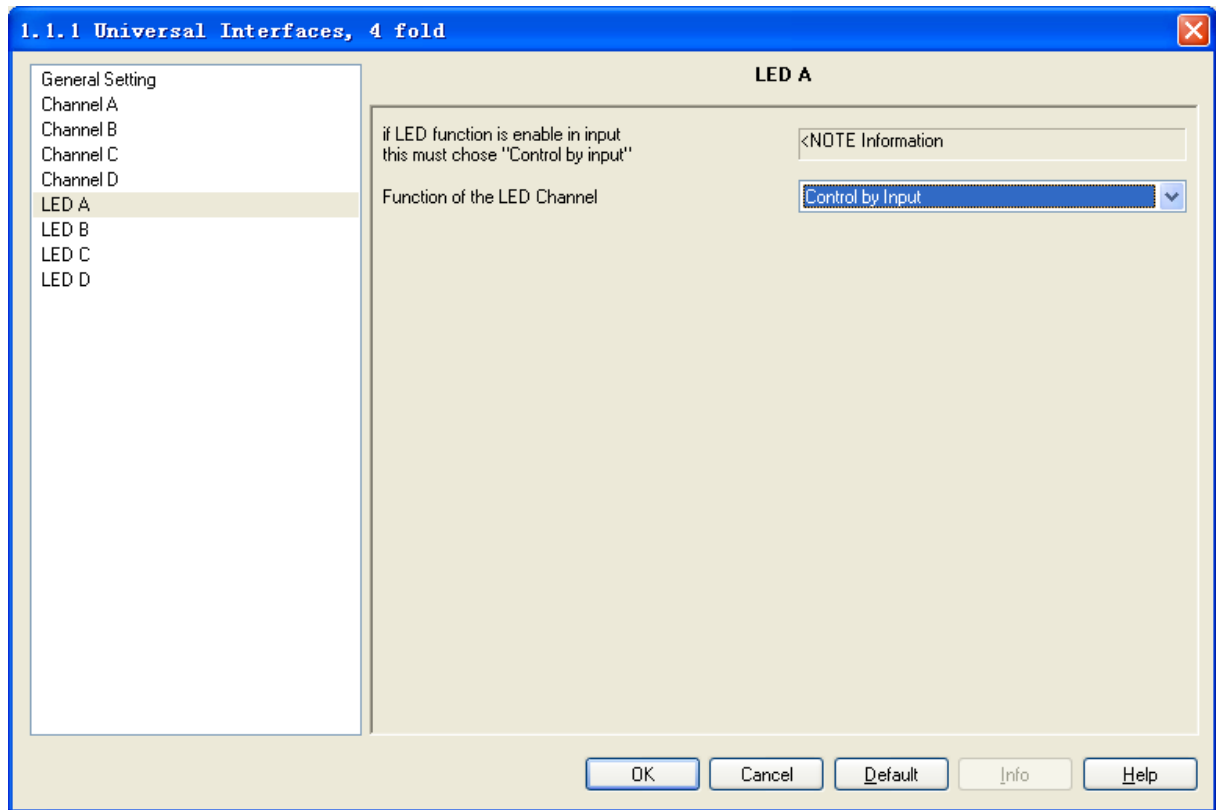

Fig.18 Parameter window “Control by input, X”

4.3.4 Parameter window “Indicate object in, X”

The parameter window “Indicate object in, X” will be shown in Fig.19, the LED is used to indicate the input of the communication object.

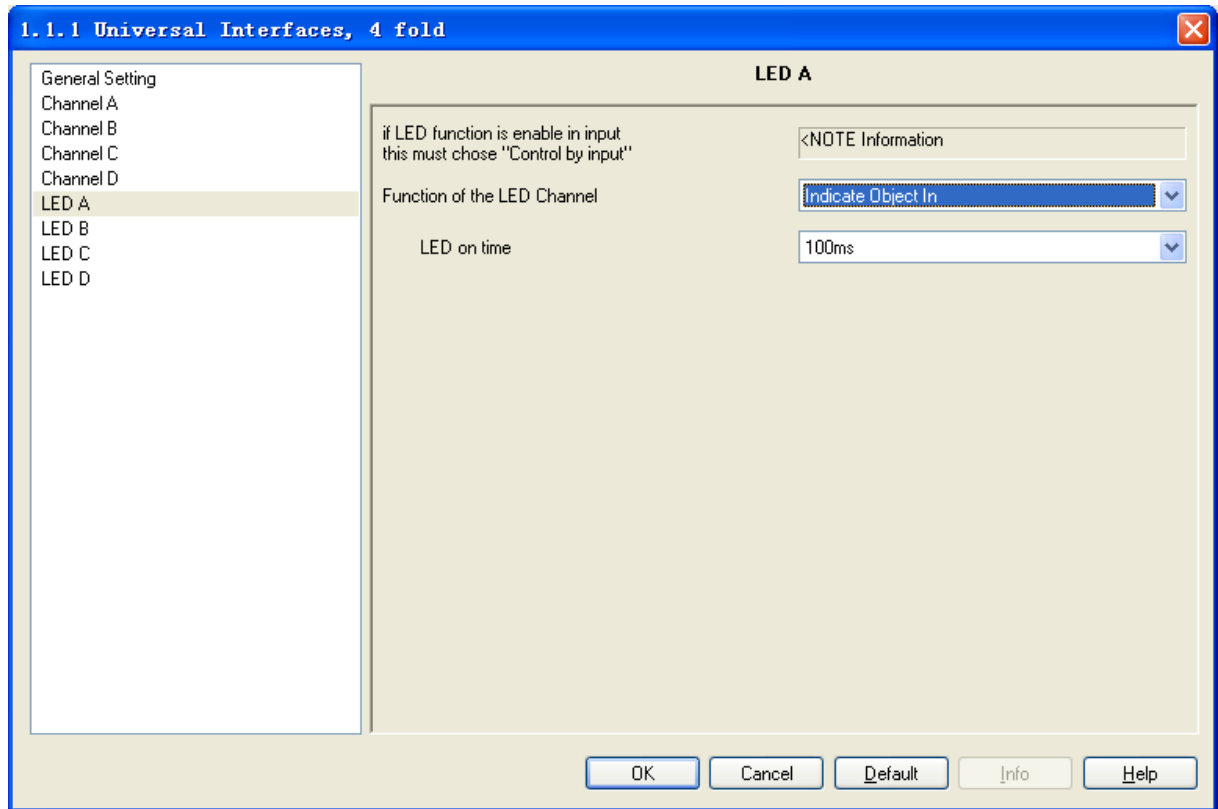

Fig.19 Parameter window “Indicate object, X”

Parameter “LED on time”

This parameter defines the indicative time of LED when there is input of communication object, which means the switch on time.

- Options: 100ms
 200ms

 60s

4.3.5 Parameter window “Indicate object out, X”

The parameter window “Indicate object out, X” will be shown in Fig.20, the LED is used to indicate the output of the communication object.

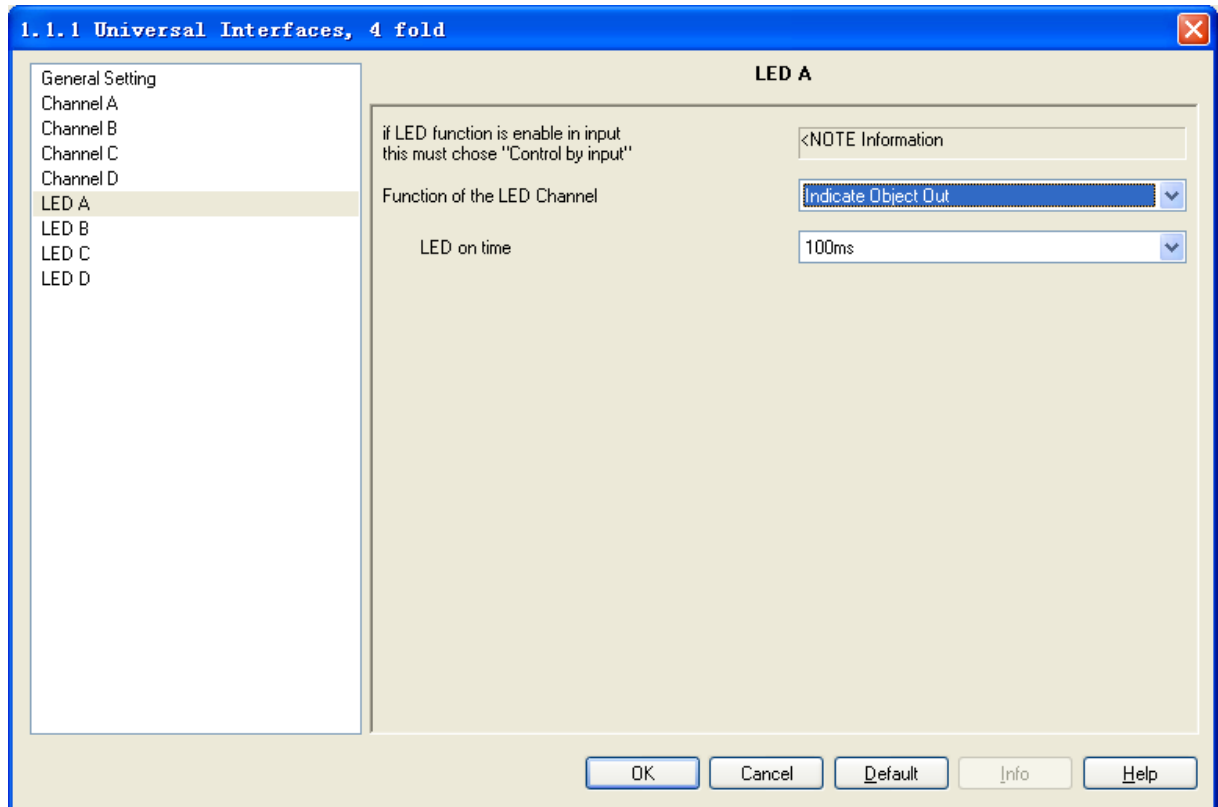

Fig.20 Parameter window “Indicate object out, X”

Parameter “LED on time”

This parameter defines the indicative time of LED when there is output of communication object, which means the switch on time.

- Options: 100ms
 200ms

 60s

4.3.6 Parameter window “Indicate object in and out, X”

The parameter window “Indicate object in and out, X” will be shown in Fig. 21, the LED is used to indicate the input and output of the communication object.

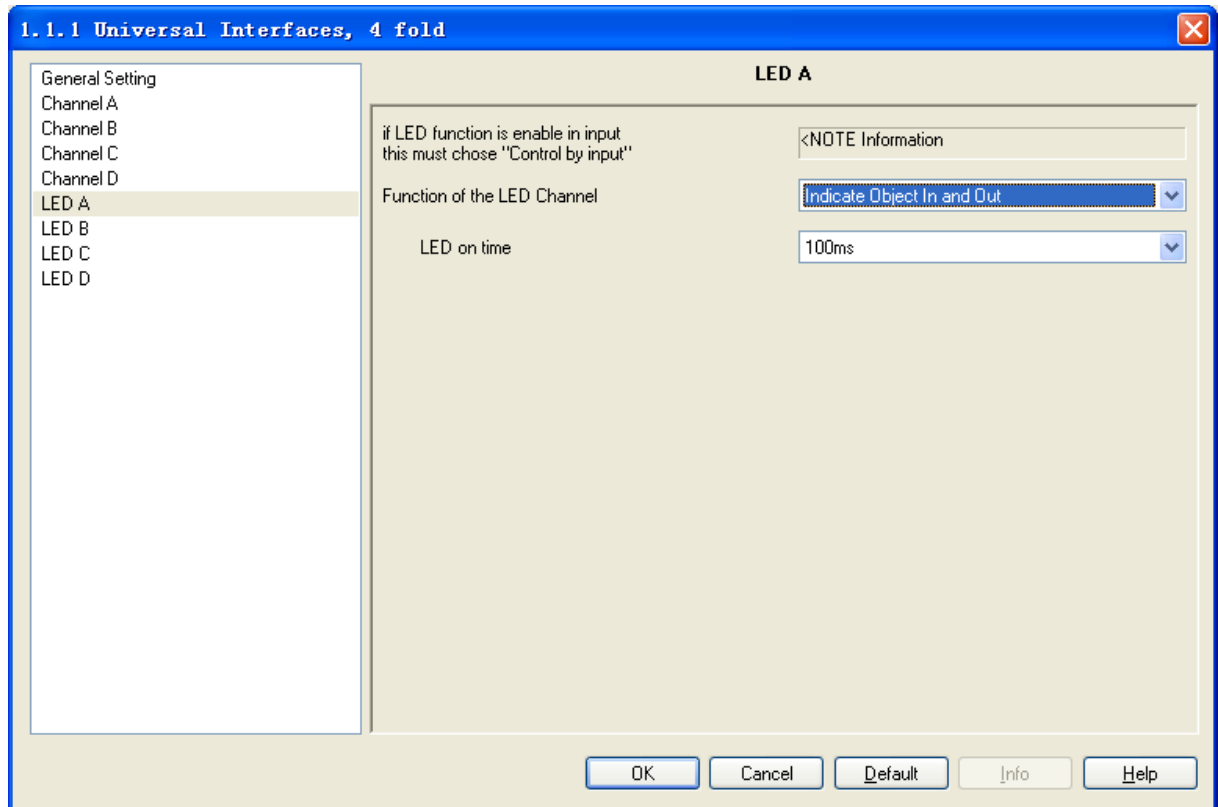

Fig.21 Parameter window “Indicate object in and out, X”

Parameter “LED on time”

This parameter defines the indicative time of LED when there is input or output of communication object, which means the switch on time.

- Options: 100ms
 200ms

 60s

5. Description of communication object

The communication object is the medium to communicate other device on the bus, which means only the communication object can communicate with bus. The communication object and

the object in each channel are the same, then use channel A as the example to introduce the function of each communication object.

5.1 Communication object “switch”

Number	Name	Object Function	Descr...	Group Addresses	Le...	C	R	W	T	U	Data Type	Pr...
0	Disable , A	CH A Disable			1 bit	C	-	W	-	-		Low
1	Switch , A	CH A Switch			1 bit	C	-	W	T	-		Low
2	Switch-long , A	CH A switch-long			1 bit	C	-	-	T	-		Low

Fig.5.1 Communication object “Switch”

Note: “C” in “Flag” column in the below table means enable the communication function of the object; “W” means it is able to modify the other devices’ value by the communication objects; “R” means the value of the object can be read by the other devices; “T” means the object has the transmission function; “U” means the value of the object can be modified by other devices.

No.	Function	Object name	Data	Flags
0	CH X Disable	Disable, X	1Bit	C,W
<p>When enable the channel function, this communication object will be active to disable/enable the channel function. The communication object will disable this function if receive a telegram with logic value “0” while it will enable the channel function if receive a telegram “1”. The control telegram sent by all objects are ineffectiveness when the channel function disable. The channel function default to enable when the bus voltage recovery.(All communication object “Disable” in channel function operate equally.)</p>				
1	CH X Switch	Switch, X	1Bit	C,W,T
<p>This communication object is visible if the channel function “Switch” is enable. It is visible no matter to distinguish short/long operation or not. Operate with button input(or a short operation) the object value to carry out the relevant action, such as ON、OFF、TOGGLE.</p>				
2	CH X Switch-long	Switch-long, X	1Bit	C,T
<p>This communication object is visible if parameter “Number of objects for short/long object operation” is “2 objects” and it is distinguish with long and short operation. Operate with a long operation to input the object value to carry out the relevant action, such as ON、OFF、TOGGLE.</p>				

Form 1 Communication object “Switch”

5.2 Communication object “switch/dimming”

Number	Name	Object Function	Descr...	Group Addresses	Le...	C	R	W	T	U	Data Type	Pr...
0	Disable , A	CH A Disable			1 bit	C	-	W	-	-		Low
1	Switch , A	CH A Switch			1 bit	C	-	W	T	-		Low
2	Dimming , A	CH A Dimming			4 bit	C	-	-	T	-		Low

Fig.5.2 Communication object “Switch/dimming”

No.	Function	Object name	Data	Flags
1	CH X Switch	Switch, X	1bit	C,W,T
It is visible if parameter “Dimming functionality” selected “Dimming and switching”. Operate with a short operation to input the object value to carry out the relevant action, such as ON、 OFF、 TOGGLE.				
2	CH X Dimming	Dimming, X	4bit	C,T
This communication object input by a long operation to send the command to dim up or dim down. It can control the dimming device on bus to carry out relative dimming. It will send a stop command to stop dimming when the long operation is end.				

Form 2 Communication object “Switch/dimming”

5.3 Communication object “value/force output”

There are many data types and communication objects, it will not list in Fig.5.3. This different data types communication object have the same operation that are transmit the input object value, which the range of transmit object value are different. It is possible to distinguish a long/short operation or not, the two objects enable when distinguished.

Number	Name	Object Function	Descr...	Group Addresses	Le...	C	R	W	T	U	Data Type	Pr...
0	Disable , A	CH A Disable			1 bit	C	-	W	-	-		Low
1	Output 1bit , A	CH A Value 1bit			1 bit	C	-	-	T	-		Low
2	Output 1bit-long , A	CH A Value 1bit-long			1 bit	C	-	-	T	-		Low

Fig. 5.3 Communication object “Value/Forced output”

No.	Function	Object name	Data type	Flags
1	CH X Value 1bit (1bit/2bit/...../4byte)	Output 1bit, X (1bit/2bit/...../4byte)	1bit (1bit/2bit/...../4byte)	C,T
This communication object is used to transmit the input value. It is only transmit the object value in short operation if distinguish a long and short operation. The value range is depend on the data type, if the data type of the communication object is different, the importability range of the object value is different. The data type depend on parameter “Reaction on (short) operation”.				
2	CH X Value 1bit-long (1bit/2bit/...../4byte)	Output 1bit-long, X (1bit/2bit/...../4byte)	1bit (1bit/2bit/...../4byte)	C,T
This communication object is visible if there is a distinction between long and short operation, it is used to transmit the object input value in long operation. The value range is depending on the data type, if the data type of the communication object is different, the importability range of the object value is different. The data type depends on parameter “Reaction on long operation”.				

Form 3 Communication object “Value/Forced output”

5.4 Communication object “scene control”

The communication object “Scene control” will be shown in Fig.5.4; it is including the actuator group and the communication object in the scene control mode. The control mode of actuator group control by 5 independent communication object, it is control by 1bit and 8bit data. The scene control mode control by a 8 bit data.

Number	Name	Object Function	Descr...	Group Addresses	Le...	C	R	W	T	U	Data Type	Pr...
0	Disable , A	CH A Disable			1 bit	C	-	W	-	-		Low
1	Output 1bit,Group-A , A	CH A 1bit,Group-A			1 bit	C	-	W	T	U		Low
2	Output 1bit,Group-B , A	CH A 1bit,Group-B			1 bit	C	-	W	T	U		Low
3	Output 1bit,Group-C , A	CH A 1bit,Group-C			1 bit	C	-	W	T	U		Low
4	Output 1bit,Group-D , A	CH A 1bit,Group-D			1 bit	C	-	W	T	U		Low
5	Output 1bit,Group-E , A	CH A 1bit,Group-E			1 bit	C	-	W	T	U		Low
6	Store scene , A	CH A Store scene			1 bit	C	-	W	T	-		Low

Number	Name	Object Function	Descr...	Group Addresses	Le...	C	R	W	T	U	Data Type	Pr...
0	Disable , A	CH A Disable			1 bit	C	-	W	-	-		Low
1	Output 8bit,Group-A , A	CH A 8bit,Group-A			1 Byte	C	-	W	T	U		Low
2	Output 8bit,Group-B , A	CH A 8bit,Group-B			1 Byte	C	-	W	T	U		Low
3	Output 8bit,Group-C , A	CH A 8bit,Group-C			1 Byte	C	-	W	T	U		Low
4	Output 8bit,Group-D , A	CH A 8bit,Group-D			1 Byte	C	-	W	T	U		Low
5	Output 8bit,Group-E , A	CH A 8bit,Group-E			1 Byte	C	-	W	T	U		Low
6	Output 8bit scene , A	CH A 8bit Scene			1 Byte	C	-	W	T	U		Low

Fig. 5.4 Communication object “Scene control”

No.	Function	Object name	Data type	Flags
1~5	CH X 1bit/8bit, Group-A...E	Output Group-A...E, X	1bit/1byte	C,W,T,U
<p>It is visible if parameter “Control the scene” selected “5 separate”. It is used to control the actuator group, it can control by a 1 bit or 8 bit data (set by parameter). When saving the scene, the value of object “output 1bit/8bit, group A...E” will be read and storage by bus. When the bus voltage recovery, the value of the object resume to the default value and the new storage value will be lost.</p>				
1	CH X 8bit Scene	Output 8bit scene, X	1 byte	C,T
<p>This communication object is visible if parameter “Control the scene” selected “8bit scene”, it is used to control the scene. It is possible to invoke or save the scene by a 8 bit command sent by this object. The definition of the 8-bit command will be described below (This object is only to communicate “C” and transmit “T”, do not have the function modify “W” and update “U”):</p> <p>Assuming an 8-bit command (binary coding) as: FXNNNNNN</p> <p style="padding-left: 40px;">F: invoke the scene with “0”; save the scene with “1”;</p> <p style="padding-left: 40px;">X: 0</p> <p style="padding-left: 40px;">NNNNNN: scene number (0...63)。</p>				
6	CH X Store scene	Store scene, X	1bit	C,W,T
<p>This parameter trigger the scene storage or indicate the accomplish of the scene by bus, decided by the mode of the scene storage. The detail storage process will be described in the scene storage parameter chapter.</p>				

Form 4 Communication object “Scene control”

5.5 Communication object “switch sequence”

The communication object “Switching sequence” will be shown in Fig.5.5. It can modify the object value with an operation step by step. Each object corresponding to one switch level.

Number	Name	Object Function	Descr...	Group Addresses	Le...	C	R	W	T	U	Data Type	Pr...
0	Disable , A	CH A Disable			1 bit	C	-	W	-	-		Low
1	Output level-1 , A	CH A Level-1			1 bit	C	-	-	T	-		Low
2	Output level-2 , A	CH A Level-2			1 bit	C	-	-	T	-		Low
3	Output level-3 , A	CH A Level-3			1 bit	C	-	-	T	-		Low
4	Output level-4 , A	CH A Level-4			1 bit	C	-	-	T	-		Low
5	Output level-5 , A	CH A Level-5			1 bit	C	-	-	T	-		Low
6	Level increment/decrement , A	CH A Level increment/decrement			1 bit	C	-	W	-	-		Low

Fig.5.5 Communication object “Switching sequence”

No.	Function	Object name	Data type	Flags
1~5	CH X level-1(1~5)	Output level-1(1~5), X	1bit	C,T
<p>The number of the communication object (maximum 5) which the levels of switch set by parameter “No. of object”. The communication object sent on bus is the object which is modified, which the value of the communication object had been changed. The detail process will be described in the switching sequence parameter chapter.</p>				
6	CH X level increment/decrement	level increment/decrement, X	1bit	C,W
<p>The communication object “level increment/decrement, X” is used to increase/decrease the level of the switch. It will increase one level when sending “1” and decrease a level when sending “0”. The detail process will be describe in the switching sequence parameter chapter.</p>				

Form 5 Communication object “Switching sequence”

5.6 Communication object “counter”

The communication object “Counter” will be shown in Fig.5.6. Including standard counter and differential counter communication object, both these communication objects are initiated counter by one operation and the counter range are the same, but the counting are independent of each other.

Number	Name	Object Function	Descr...	Group Addresses	Le...	C	R	W	T	U	Data Type	Pr...
0	Disable, A	CH A Disable			1 bit	C	-	W	-	-		Low
1	Output counter value 1byte, A	CH A Counter value			1 Byte	C	-	W	T	-		Low
2	Differential Count 1byte, A	CH A Differential Counter			1 Byte	C	-	W	T	-		Low
3	Request counter value, A	CH A Request counter value			1 bit	C	-	W	-	-		Low
4	Differential counter overflow...	CH A Differential overflow			1 bit	C	-	-	T	-		Low
5	Reset differential counter, A	CH A Rst differential counter			1 bit	C	-	W	-	-		Low

Fig.5.6 Communication object “Counter”

No.	Function	Object name	Data type	Flags
1	CH X Counter value	Output counter value 1byte, X (1byte/2byte/4byte)	1Byte (1byte/2byte/4byte)	C,W,T
<p>This communication object is used to transmit the current counting value of the standard counter, and it can modify the counting value simultaneously. Different data type makes the different counting range, it is defines by parameter “Date width of counter”.</p>				
2	CH X Differential Counter	Differential Counter 1byte, X (1byte/2byte/4byte)	1Byte (1byte/2byte/4byte)	C,W,T
<p>It is visible if enable the parameter “Enable differential counter”. This communication object is used to transmit the current counting value of the differential counter, and it can modify the counting value simultaneously. Different data type makes the different counting range, it is defines by parameter “Date width of counter”.</p>				
3	CH X Request Counter value	Request Counter value, X	1Bit	C,W
<p>This communication object is used to ask for the current counting value of the standard counter and the differential counter. The communication object “CH X Counter value” and “CH X Differential Counter” will transmit the current counting value if receive a logic value “1”, it will no reaction if receive a logic value “0” telegram.</p>				
4	CH X Differential overflow	Differential counter overflow, X	1Bit	C,T

It is visible if enable the parameter “Enable differential counter”. Once the counting of the differential counter exceed the overflow value preset by parameter “Over-/under run of differential at [0...255]”, it will send telegram “1” on bus to report the overflow.

5	CH X Rst Differential Counter	Reset Differential Counter, X	1Bit	C,W
---	-------------------------------	-------------------------------	------	-----

It is visible if enable the parameter “Enable differential counter”. It is used to reset the counting value of the differential counter, which counting from 0.It will reset the counting value if receive a logic value “1”telegram, and it will no reaction if receive a “0”.

Form 6 Communication object “Counter”

5.7 Communication object “multiple operation”

The communication object “Multiple Operation” will be shown in Fig.5.7. The value of the designate operation object will be modify if detect multiple operation in period.

Number	Name	Object Function	Descr...	Group Addresses	Le...	C	R	W	T	U	Data Type	Pr...
0	Disable , A	CH A Disable			1 bit	C	-	W	-	-		Low
1	Output 1-fold , A	CH A 1-fold			1 bit	C	-	-	T	-		Low
2	Output 2-fold , A	CH A 2-fold			1 bit	C	-	-	T	-		Low
3	Output 3-fold , A	CH A 3-fold			1 bit	C	-	-	T	-		Low
4	Output 4-fold , A	CH A 4-fold			1 bit	C	-	-	T	-		Low
5	Output Long-fold , A	CH A Long-fold			1 bit	C	-	-	T	-		Low

Fig.5.7 Communication object “Multiple operation”

No.	Function	Object name	Data type	Flags
1~4	CH X 1-fold(1~4)	Output 1-fold, X(1~4)	1Bit	C,T

The number of the communication object (maximum 4) is set by parameter “Max. number of operations(=Num. of objects)”. If there are multiple operation, multiple objects will send the relevant telegram on bus, which the telegram set by parameter “value send (object “Tele. Operation...-fold)”. The detail operation process will be describe in the multiple operation parameter chapter.

5	CH X Long-fold	Output Long-fold, X	1Bit	C,T
---	----------------	---------------------	------	-----

It is visible if parameter “Additional object for long operation” selected “yes”. Once detected a long operation the object will send telegram on bus, the telegram is set by parameter “value send (object “Tele. Long operation)””.

Form 7 Communication object “Multiple operation”

5.8 Communication object “shutter control”

The communication object “Shutter Control” will be shown in Fig.5.8

Number	Name	Object Function	Descr...	Group Addresses	Le...	C	R	W	T	U	Data Type	Pr...
0	Disable , A	CH A Disable			1 bit	C	-	W	-	-		Low
1	Output shutter UP/DOWN , A	CH A shutter UP/DOWN			1 bit	C	-	-	T	-		Low
2	Output Stop/lamella adj , A	CH A Stop/lamella adj			1 bit	C	-	-	T	-		Low
3	Upper limit position , A	CH A Upper limit position			1 bit	C	-	W	-	-		Low
4	Lower limit position , A	CH A Lower limit position			1 bit	C	-	W	-	-		Low

Fig.5.8 Communication object “Shutter control”

No.	Function	Object name	Data type	Flags
1	CH X shutter UP/DOWN	Output shutter UP/DOWN, X	1Bit	C,T

This communication object move up/down the shutter by sending command by bus. It will move down if the communication object send a “1” telegram, it will move up if sending a “0”.

2	CH X Stop/adjust adj	Output Stop/adjust adj, X	1Bit	C,T
It will stop/adjust the shutter by sending command by bus. It will stop/ adjust down if sending a “1” telegram, and it will stop/adjust up if sending “0”.				
3	CH X Upper limit position	Upper limit position, X	1Bit	C,W
It is used to limit the upper moving. It is limit the upper moving if the object receive a logic value “1”, and negate it if receive “0”.				
4	CH X Lower limit position	Lower limit position, X	1Bit	C,W
It is used to limit the lower moving. It is limit the lower moving if the object receive a logic value “1”, and negate it if receive “0”.				

Form 8 Communication object “Shutter control”

5.9 Communication object “LED X—flashing”

The communication object “LED X—Flashing” will be shown in Fig.5.9.

Number	Name	Object Function	Descr...	Group Addresses	Le...	C	R	W	T	U	Data Type	Pr...
28	LED flashing, A	LED A Flashing			1 bit	C	-	W	-	-		Low
29	LED permanent on, A	LED A Permanent on			1 bit	C	-	W	-	-		Low
30	Send its status, A	LED A Send its status			1 bit	C	-	-	T	-		Low

Fig.5.9 Communication object “LED X-Flashing”

No.	Function	Object name	Data type	Flags
28	LED X Flashing	LED. Flashing, X	1Bit	C,W
It is used to control the LED flashing. It will start flashing if receive “1” or “0” telegram (defines by “LED flashing, if”), the flashing time set by parameter. And it will stop LED if receive “0” or “1”.				
29	LED X Permanent on	LED permanent on, X	1Bit	C,W
It is used to open LED for a long period and its priority is higher than the communication object “LED. Flashing, X”. It will open LED if receive telegram “1”, negate priority and the LED resume the foregoing operation if receive “0”.				
30	LED X Send its status	Send its status, X	1Bit	C,T
It is visible if “Send status by object “Tele. Status”” selected “Yes”, it is used to send the status of LED. Sending “1” means LED open or flashing, and sending “0” means the LED is stop. The object LED. Flashing, X” will send telegram “1” if sending open flashing requirement every time.				

Form 9 Communication object “LED X-Flashing”

5.10 Communication object “LED X—SWITCH”

The communication object “LED X—Switch” will be shown in Fig.5.10

Number	Name	Object Function	Descr...	Group Addresses	La...	C	R	W	T	U	Data Type	Pr...
28	LED switch , A	LED A Switch			1 bit	C	-	W	-	-		Low
29	LED permanent on , A	LED A Permanent on			1 bit	C	-	W	-	-		Low
30	Send its status , A	LED A Send its status			1 bit	C	-	-	T	-		Low

Fig.5.10 Communication object “LED X-Switch”

No.	Function	Object name	Date type	Flags
28	LED X Switch	LED. switch, X	1Bit	C,W
This communication object is used to open LED. It will open LED if the object receive a “1” or “0” telegram (defines by “LED is Switch ON, if”), the open time can be set by parameter; it will stop LED if receive “0” or “1”.				
29	LED X Permanent on	LED permanent on, X	1Bit	C,W
It is used to open LED for a long period and its priority is higher than the communication object “LED. switch, X”. It will open LED if receive telegram “1”, negate priority and the LED resume the foregoing operation if receive “0”.				
30	LED X Send its status	Send its status, X	1Bit	C,T
It is visible if “Send status by object “Tele. Status”” selected “Yes”, it is used to send the status of LED. Sending “1” means LED open, and sending “0” means the LED is stop. The object LED. switch, X” will send telegram “1” if sending open requirement every time.				

Form 10 Communication object “LED X-Switch”