

1 Product Page / Application Description

The following section describes the installation, the existing connections, the specifications and the commissioning and parameterisation by the ETS.

1.1 Product Page

3,5" Display for visualisation and control in KNX systems.

The **Touch_IT C3-AE-IP65** (on-wall, outdoor / damp room, IP65) is mounted with 2 screws onto the wall.

Installation **Touch_IT C3-xxx** is carried out using a mounting ring. Magnetic elements and the locking screw are used for fixation in a standard 60 mm in-wall socket.

The Touch_IT features an integrated KNX bus coupler and requires additional voltage 9 .. 32VDC / 1,5W.

Different control elements are available for the application software.

The Touch_IT must be projected using the ETS (EIB Tool Software) and the application program. Control elements and page layout can be parametrized using the ETS.

Touch_IT C3 -AE-IP65	On wall mounting Aluminium anodized	22310265
Touch_IT C3 -AE	Metal housing with bevel Aluminium sandblasted anodized	22310200
Touch_IT C3 -AW	Metal housing with bevel Aluminium sandblasted white powder-coated	22310201
Touch_IT C3 -SAE	Metal housing square-edged Aluminium sandblasted anodized	22310300
Touch_IT C3 -SAS	Metal housing square-edged Aluminium sanded anodized	22310303
Touch_IT C3 -SAB	Metal housing square-edged Aluminium sanded black anodized	22310304
Touch_IT C3 -SAG	Metal housing square-edged Aluminium sanded steel grey anodized	22310305
Touch_IT C3 -SMB	Metal housing square-edged Brass sanded bronzed	22310400
Touch_IT C3 -SMG	Metal housing square-edged Brass polished gold plated	22310407



Areas of Application

- Switching and dimming of lights
- Adjustment of color and brightness in RGB lights
- Displaying switching states in a building
- Switching various devices on and off
- Operating blinds
- Alarm functions, acoustic and optical
- Alarm display of motion sensors with clear text
- Displaying and setting heating adjustments
- Displaying indoor and outdoor temperature
- Weekly time switch

Display: 3,5" TFT Touchscreen
 Processor: 200MHz 32-Bit ARM
 Operating System: Linux

Additional Voltage: 9 .. 32VDC / ca. 1,5W

Ambient Temperature Operation: -5 .. +55 °C
 Ambient Temperature Storage: -5 .. +60 °C

Optional Temperature-Probe: 1-Wire bus

Ambient temperature according to manufacturer's specifications.

Protection Touch_IT C3-AE-IP65: IP65
 Protection Touch_IT C3-xxx: IP20

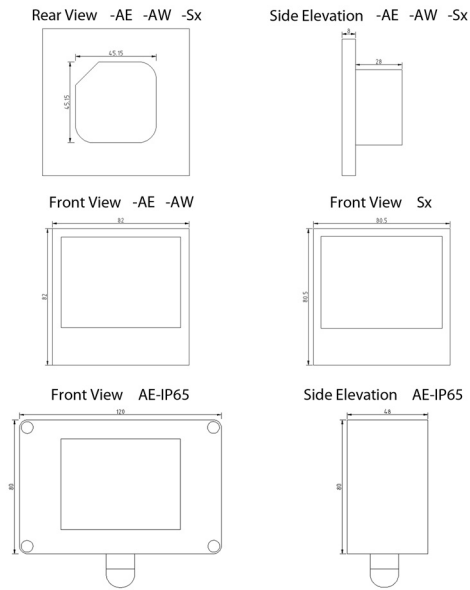

Commisioning and Connector Description

Commissioning the KNX display is carried out using the ETS (EIB Tool Software) and the corresponding application software. At delivery, the device is unprogrammed. All functions must be parameterized and programmed using the ETS. Please review the documentations belonging to the ETS.

The touch screen is designed for in-wall installation. The degree of protection is IP20. Installation is carried out using the support ring and the magnetic fixing. A locking screw type Torx-6 serves for fixation.

The connections of the Touch_IT C3-AE-IP65 are identical.
 Das Touch_IT C3 AE-IP65 wird mittels zwei Schrauben an der Wand o.ä. befestigt.

Please make sure that electronic parts do not get damaged by tools or cable ends during installation.

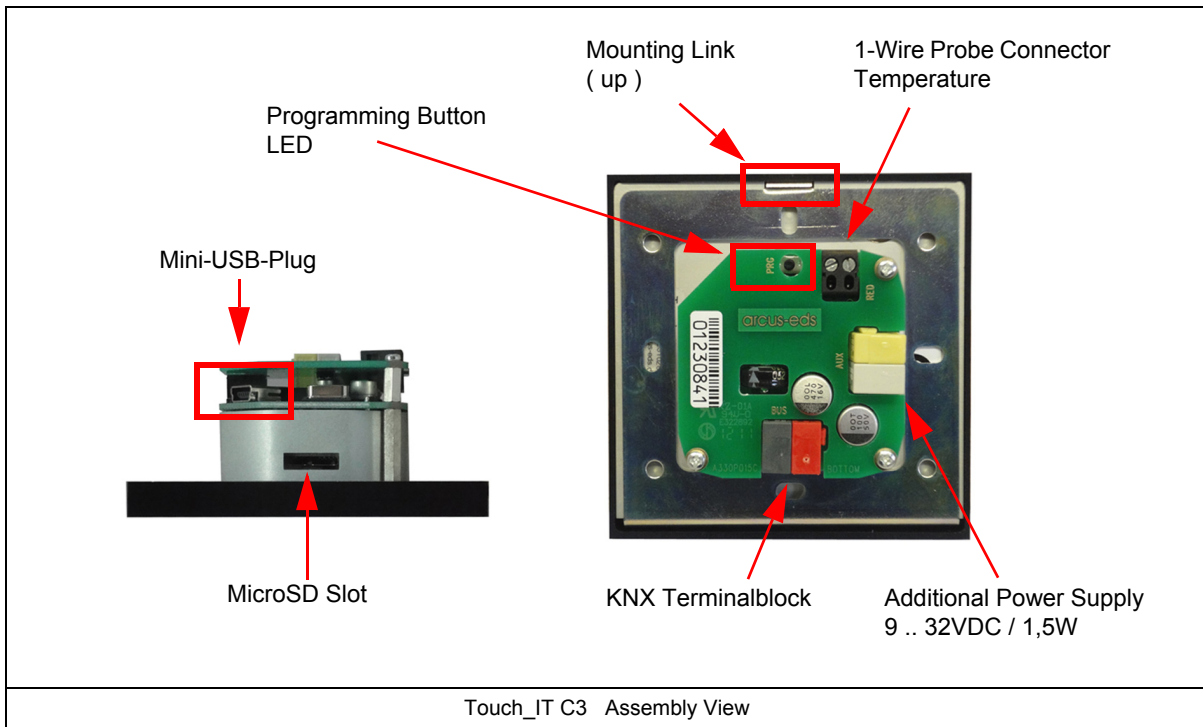

In Wall Mounting

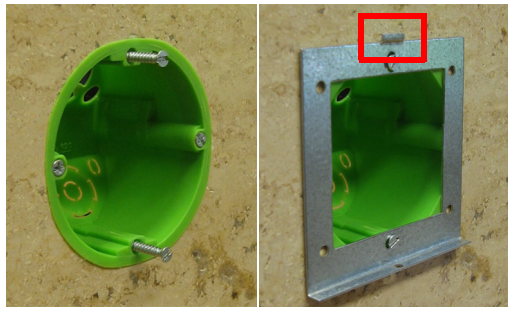
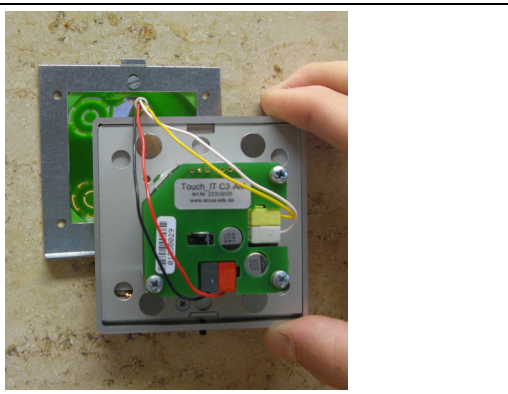
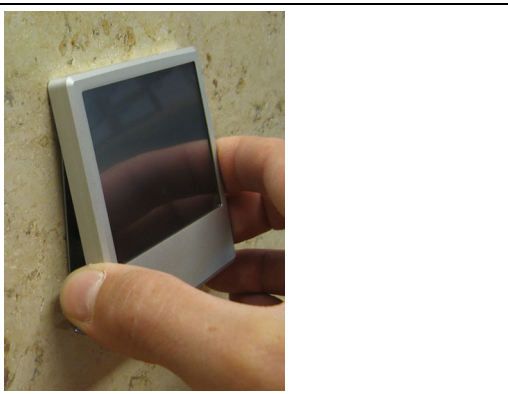
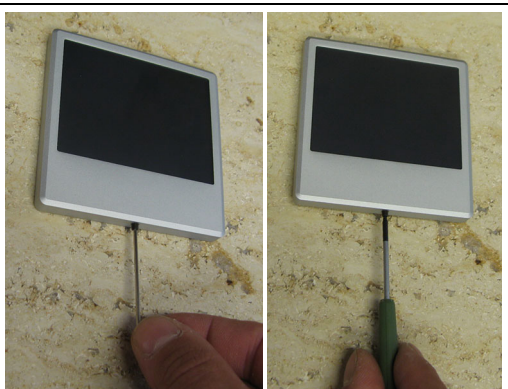
	<p>Fix the frame on the flush-mounted box. The nose has to be pointing upwards.</p>
	<p>Connect the Touch_IT with the KNX-Bus (black / red) and the auxiliary voltage (white - / yellow +).</p>
	<p>Insert the Touch_IT carefully in the box, (Attention, do not the electronic parts damage!) tip it slightly and hook it in at the nose.</p>
	<p>For fixture use the screw on the under-neath. (Allen Key 1,5mm / or Torx 6)</p>

Technical Data

Display	3,5" TFT color display (320x240 RGB) (256k color) touchscreen
Processor	200MHz 32-Bit ARM
Operating system	Linux
Background	Adjustable LED background light
Parameterization	ETS
Max. number of elements / Max. number of pages	8 / (5 control pages + 1 alarm page or 6 control pages)
Ambient temperature, storage	-5 .. +60 °C
Ambient temperature in operation	-5 .. +55 °C
Operational voltage	EIB/KNX bus voltage 21 .. 32VDC
Approx. power consumption	10 mA (at 24V DC)
Additional voltage	9 .. 32VDC / approx. 1.5 W
Bus coupler	Integrated
Commissioning via ETS	Touch_IT_xxx.pr5
Connections	EIB-2-polar terminal (red / black) AUX-2-polar terminal (yellow / white)
Optional Temperature Probe (1-Wire)	Yes
On-Wall	
Degree of protection	IP65
Installation type	On wall mounting
Casing	Aluminium anodized
Casing measurements	120 x 80 x 48 mm (W x H x D)
Articlenumber	22310265
In-Wall	
Degree of protection	IP20
Installation type	Installation with a mounting ring
Casing	Various
Casing measurements with bevel	82 x 82 x 8 mm (W x H x D)
Casing measurements square-edged	80,5 x 80,5 x 8 mm (W x H x D)
Articlenumber	22310xxx

Behaviour at Bus Voltage Recovery

All settings carried out using the ETS will be preserved.

Discharging Program and Resetting Device

If the visualization does not react due to a malfunction or incorrect configuration of the programming, the entire project work can be deleted by pressing the programming button. The device will be reset to delivery status. Please hold the programming button while connecting power supply and wait until the application for touch screen calibration appears. Normally, this takes 40-60 seconds. After entering the 5 calibration points, you can transmit your application once again.

1.2 Application Description

The following are the main settings for the Touch_IT in the ETS software are described.
A detailed description follows in Chapter 2, **Description Widgets**.

1.2.1 Main Setting in the ETS

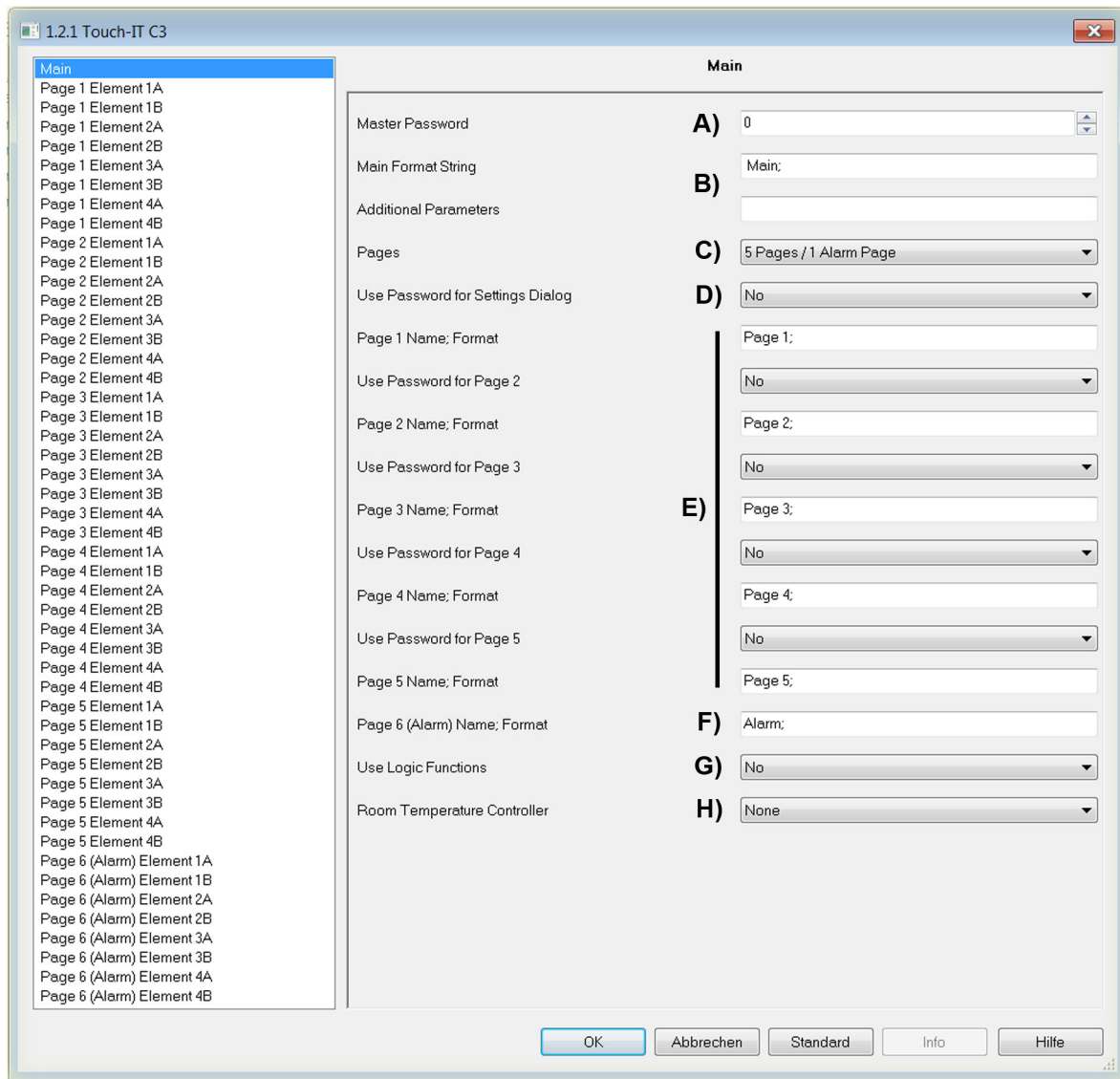

A) Master Password

A 4-digit password can be assigned to protect the different pages or object functions. In case that the value is "0", this function is inactive.

e.g.

In case that the password is "1", "0001" must be entered on the Touch_IT in order to access the protected page or to execute a function of the protected element.

B) Main Format String and Additional Parameters

These fields are used for global parameter setting. The following parameters can be used:

TDSEND	No default value assigned. Date and time will not be sent.
TDSEND=xx	Time allowance for sending time and date. Specified in solid hours. e.g. TDSEND=17 (Time and date will be sent every day at 5 pm)
STDLONG	Interpretation of a manual input as LONG (Default 500ms)
STDLONG=xx	Determines the time (in ms) from which the manual input will be taken as LONG.
STDREP	Default use of the general repetition rate. (Default 300ms)
STDREP=xx	Sets the repetition rate (in ms)
LAYOUT	Disables user's choice. Forces registered layout.
PGH	Defines the maximum display height for the widgets. The menu bar adapts to fill the display.

Two more parameters can be set in order to control standby object 194.

OBJ194OUT

This parameter determines how the output object reacts when the screen saver mode is changed. Values can be sent when activating and leaving the screen saver. The following scheme demonstrates the settings in dependency on the desired actions. Standby mode will be interpreted as an extended screen saver mode.

		Screensaver inaktiv			
		0	1	x	
Screensaver aktiv (oder Standby)	0	--	SW	Sx	
	1	WS	--	xS	
	x	Wx	xW	--	
	Demonstration: Standby object parameters are to be set as follows: „Send a 1 when activating and a 0 when leaving the screen saver mode“. The outcome of this is: OBJ194OUT=WS;				

OBJ194IN

Incoming telegrams on the system standby object can change the current status of the screen saver. The changes can be defined for the values 0/1, as demonstrated in the following scheme.

		Possible settings				
		xx	Ox	Sx	Wx	
Input	0	--	Standby	Screensaver	Wake-Up	
	1	--	--	--	--	
			xO	OO	SO	WO
	0	--	Standby	Screensaver	Wake-Up	
	1	Standby	Standby	Standby	Standby	
			xS	OS	SS	WS
	0	--	Standby	Screensaver	Wake-Up	
	1	Screensaver	Screensaver	Screensaver	Screensaver	
			xW	OW	SW	WW
	0	--	Standby	Screensaver	Wake-Up	
	1	Wake-Up	Wake-Up	Wake-Up	Wake-Up	
	Demonstration: The interpretation of an incoming telegram is to be carried out as follows: Change into standby mode at 0, and into wake-up mode at 1 OBJ194IN=OW;					

C) Pages

There are two possible options:

- 5 control pages + 1 alarm page
- 6 control pages

D) Use Password for Settings Dialog

Protect system page with a 4-digit password.

E) Page 1-5 Name; Format

The names of the control pages that appear in the layout menu can be assigned here.
The breakdown of widgets per page is homogeneous. By using of the parameter INHOM the page distribution will be set inhomogeneous. The advantages of inhomogeneous distribution is when different sized images are used on the page.

Use Password for Page 2-5

Except for control page 1, all service pages can be protected/locked with a password.
(Exception: When 6 control pages are defined, page 6 also can be protected with a password.)

F) Page 6 (Alarm) Name; Format

The name of the control or alarm page that appears in the layout menu can be assigned here.
In addition, global alarm settings can be set here.

- RESCAN : Defines the time (in s) when alarm object is rescanned.
- BEEPOFF : Number of acoustic alarm signals
- AUTOHIDE : Leave alarm page if alarm condition is changed or confirmed in a different point.

G) Using Logic Functions

Further information on the logic functions is given in chapter 6, **Logic**.

H) Using Temperature Control

Further information on the regulation of the room temperature is given in chapter 5, **RTR**.

1.2.2 ETS Objects

Up to 196 group addressed can be administered. If no elements are activated yet, only the system objects within topology are displayed.

Nummer	Name	Gruppenadressen	Funktion	Datentyp	Länge	K	L	S	Ü	A	Priorität
192	System Time		Time	Time DPT_TimeOfDay	3 Byte	K	L	-	Ü	-	Niedrig
193	System Date		Date	Date DPT_Date	3 Byte	K	L	-	Ü	-	Niedrig
194	System Standby		Standby	1 bit DPT_Switch	1 bit	K	L	S	-	A	Niedrig
195	System LED1		LED	1 bit DPT_Switch	1 bit	K	L	S	-	A	Niedrig

e.g. Element 1A ist active on page 1 and defined as a 1-bit object. Topology will change as follows:

Nummer	Name	Gruppenadressen	Funktion	Datentyp	Länge	K	L	S	Ü	A	Priorität
10	1.1-A Output, Switching		Switch	1 bit DPT_Switch	1 bit	K	L	S	Ü	A	Niedrig
11	1.1-A Input, Feedback		Switch	1 bit DPT_Switch	1 bit	K	L	S	Ü	A	Niedrig
192	System Time		Time	Time DPT_TimeOfDay	3 Byte	K	L	-	Ü	-	Niedrig
193	System Date		Date	Date DPT_Date	3 Byte	K	L	-	Ü	-	Niedrig
194	System Standby		Standby	1 bit DPT_Switch	1 bit	K	L	S	-	A	Niedrig
195	System LED1		LED	1 bit DPT_Switch	1 bit	K	L	S	-	A	Niedrig

Every element includes function-specific objects that can be linked (Cf. chapter 2, **Elements**). The exact analogy between parameter view and object view within topology will be displayed as follows:

e.g. Page 3,element 2B equals 3.2-B within topology.

The following matrix will lead to an overview of the implemented elements and their possibilities for parameterization.
(For advanced users !)





* The detailed description of the widgets, please refer to the Touch_IT documentation.

File: **1100_ex_Touch_IT C3.pdf**
Download under: **www.arcus-eds.de**

 1 Bit	 1 Byte	 2 Byte	 3 Byte
 4 Byte	 14 Byte	 Szenen	 Licht/RGB
 Dimmer	 Jalousien	 RTR	 Timer
 Datalogging			



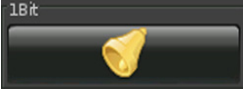







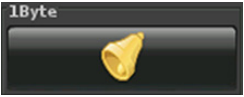

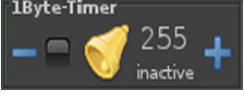

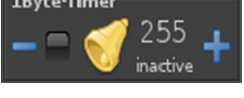

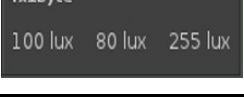
2.4 Overview 1-bit Elements

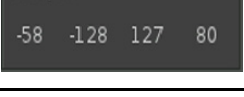
Image	Element Number	Element Type	Details Page
	Range of Values	Format	
	1	1-bit-ON/OFF-Toggle-Text	 *
	0/1	B0,B1,AL,AH,NOBG,LOGIC,BSWAP,RDRQ,PIN	
	2	1-bit-ON/OFF-Toggle-Picture	 *
	0/1	IMGSET,AL,AH,NOBG,LOGIC,BSWAP,RDRQ,PIN	
	3	1-bit-ON/OFF-Toggle-Text with Value	 *
	0/1	W,L0,L1,B0,B1,AL,AH,NOBG,LOGIC,BSWAP,LSWAP,RDRQ,PIN	
	4	1-bit-ON/OFF-Toggle-Picture with Value	 *
	0/1	W,IMGSET,L0,L1,B0,B1,AL,AH,NOBG,LOGIC,BSWAP,LSWAP,RDRQ,PIN	
	5	1-bit-ON/OFF-Text with Value	 *
	0/1	W,L0,L1,B0,B1,AL,AH,NOBG,LOGIC,BSWAP,LSWAP,RDRQ,PIN	
	6	1-bit-ON/OFF-Picture with Value	 *
	0/1	W,L0,L1,B0,B1,IMGSET,AL,AH,NOBG,LOGIC,BSWAP,LSWAP,RDRQ,PIN	
	40	1-Bit-Value-Pushbutton	 *
	0/1	IMG,PRESS,RELEASE,LABEL,NOBG,JUMP,LOGIC,LOGICR,PIN	
	62	1-Bit-Timer-Profile	 *
	0/1	W,L0,L1,OVRTO,NOBG,IMG,RDRQ,PIN,PPIN	
	85	1-bit-Quad-ON/OFF-Status/Toggle-Text	 *
	4x 0/1	LABELS,N,W,NOBG,ALARM,RDRQ,PIN	
	86	1-bit-Quad-ON/OFF-Status/Toggle-Picture	 *
	4x 0/1	IMGSETS,N,W,NOBG,ALARM,RDRQ,PIN	
	87	1-bit-Quad-Value-Pushbutton-Text	 *
	4x 1	LABELS,N,W,NOBG,PRESS,PIN	
	88	1-bit-Quad-Value-Pushbutton-Picture	 *
	4x 1	IMGSETS,N,W,NOBG,PRESS,PIN	

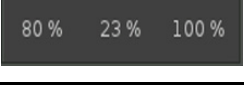
2.5 Overview 1-Byte Elements

Image	Element Number	Element Type	Details Page
	Range of Values	Format	
	10	1-Byte-Value-Text-Button 0 .. 255	 *
	0 .. 255	W,B-,B+,PF,STEPS,MIN,MAX,AL,AH,NOBG,REP,RDRQ,PIN	
	11	1-Byte-Value-Picture-Button 0 .. 255	 *
	0 .. 255	W,PF,IMGSET,STEPS,MIN,MAX,AL,AH,NOBG,REP,IMGVAL,RDRQ,PIN	
	12	1-Byte-Value-Slider 0 .. 255	 *
	0 .. 255	W,PF,IMGSET,STEPS,MIN,MAX,AL,AH,NOBG,REP,RDRQ,PIN	
	13	1-Byte-Value-Text-Button -128 .. 127	 *
	-128 .. 127	W,B-,B+,PF,STEPS,MIN,MAX,AL,AH,NOBG,REP,RDRQ,PIN	
	14	1-Byte-Value-Picture-Button -128 .. 127	 *
	-128 .. 127	W,PF,IMGSET,STEPS,MIN,MAX,AL,AH,NOBG,REP,IMGVAL,RDRQ,PIN	
	15	1-Byte-Value-Slider -128 .. 127	 *
	-128 .. 127	W,PF,IMGSET,STEPS,MIN,MAX,AL,AH,NOBG,REP,RDRQ,PIN	
	16	1-Byte-Value-Text-Button 0 .. 100%	 *
	0 .. 255	W,B-,B+,PF,STEPS,MIN,MAX,AL,AH,NOBG,REP,RDRQ,PIN	
	17	1-Byte-Value-Picture-Button 0 .. 100%	 *
	0 .. 255	W,PF,IMGSET,STEPS,MIN,MAX,AL,AH,NOBG,REP,IMGVAL,RDRQ,PIN	
	18	1-Byte-Value-Slider 0 .. 100%	 *
	0 .. 255	W,PF,IMGSET,STEPS,MIN,MAX,AL,AH,NOBG,REP,RDRQ,PIN	
	19	1-Byte-Value-Text-Button 0 .. 360°	 *
	0 .. 255	W,B-,B+,PF,STEPS,MIN,MAX,AL,AH,NOBG,REP,RDRQ,PIN	
	20	1-Byte-Value-Picture-Button 0 .. 360°	 *
	0 .. 255	W,PF,IMGSET,STEPS,MIN,MAX,AL,AH,NOBG,REP,IMGVAL,RDRQ,PIN	
	21	1-Byte-Value-Slider 0 .. 360°	 *
	0 .. 255	W,PF,IMGSET,STEPS,MIN,MAX,AL,AH,NOBG,REP,RDRQ,PIN	

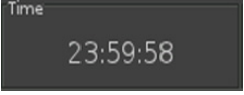

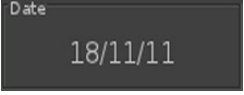

Image	Element Number	Element Type	Details
	Range of Values	Format	Page
	41	1-Byte-Value-Pushbutton	 *
	0 .. 255	IMG,PRESS,RELEASE,LABEL,NOBG,JUMP,LOGIC,LOGICR,PIN	
	63	1-Byte-Timer-Profile 0 .. 100%	 *
	0 .. 255	W,PF,MIN,MAX,STEP,OVRTO,NOBG,IMG,RDRQ,PIN,PPIN	
	64	1-Byte-Timer-Profile 0 .. 255	 *
	0 .. 255	W,MIN,MAX,STEP,OVRTO,NOBG,IMG,RDRQ,PIN,PPIN	
	89	1-Byte-Quad-Value/Change 0 .. 255	 *
	4x (0 .. 255)	W,PF,N,RDRQ	
	90	1-Byte-Quad-Value/Change -128 .. 127	 *
	4x (-128 .. 127)	W,PF,N,RDRQ	
	91	1-Byte-Quad-Value/Change 0 .. 100%	 *
	4x (0 .. 255)	W,PF,N,RDRQ	
	92	1-Byte-Quad-Value/Change 0 .. 360°	 *
	4x (0 .. 255)	W,PF,N,RDRQ	



2.6 Overview 2-Byte Elements



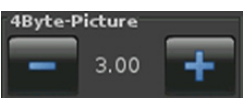



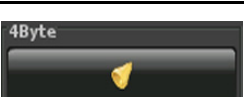

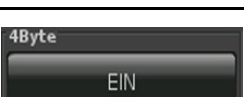

Image	Element Number	Element Type	Details Page
	Range of Values	Format	
	22	2-Byte-Value-Text-Button 0 .. 65535	> *
	0 .. 65535	W,B-,B+,PF,STEPS,MIN,MAX,AL,AH,NOBG,REP,RDRQ,PIN	
	23	2-Byte-Value-Picture-Button 0 .. 65535	> *
	0 .. 65535	W,PF,IMGSET,STEPS,MIN,MAX,AL,AH,NOBG,REP,RDRQ,PIN	
	24	2-Byte-Value-Slider 0 .. 65535	> *
	0 .. 65535	W,PF,IMGSET,STEPS,MIN,MAX,AL,AH,NOBG,REP,RDRQ,PIN	
	25	2-Byte-Value-Text-Button -32768 .. 32767	> *
	-32768 .. 32787	W,B-,B+,PF,STEPS,MIN,MAX,AL,AH,NOBG,REP,RDRQ,PIN	
	26	2-Byte-Value-Picture-Button -32768 .. 32767	> *
	-32768 .. 32787	W,PF,IMGSET,STEPS,MIN,MAX,AL,AH,NOBG,REP,RDRQ,PIN	
	27	2-Byte-Value-Slider -32768 .. 32767	> *
	-32768 .. 32787	W,PF,IMGSET,STEPS,MIN,MAX,AL,AH,NOBG,REP,RDRQ,PIN	
	30	2-Byte-Float-Text-Button	> *
	-671088.64 .. 670760,96	W,B-,B+,PF,STEPS,MIN,MAX,AL,AH,NOBG,REP,RDRQ,DC,PIN,*	
	31	2-Byte-Float-Picture-Button	> *
	-671088.64 .. 670760,96	W,PF,IMGSET,STEPS,MIN,MAX,AL,AH,NOBG,REP,RDRQ,DC,PIN,*	
	32	2-Byte-Float-Slider	> *
	-671088.64 .. 670760,96	W,PF,IMGSET,STEPS,MIN,MAX,AL,AH,NOBG,REP,RDRQ,DC,PIN,*	
	42	2-Byte-Value-Pushbutton	> *
	0 .. 65535	IMG,PRESS,RELEASE,LABEL,NOBG,JUMP,LOGIC,LOGICR,PIN	
	43	2-Byte-Float-Value-Pushbutton	> *
	-671088.64 .. 670760,96	IMG,PRESS,RELEASE,LABEL,NOBG,JUMP,LOGIC,LOGICR,PIN	
	66	2-Byte-Float-Timer-Profile	> *
	-671088.64 .. 670760,96	W,PF,MIN,MAX,STEP,OVRTO,NOBG,IMG,RDRQ,PIN,PPIN	

2.7 Overview 3-Byte Time / Date Elements

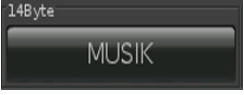

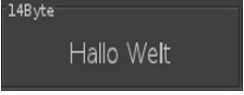

Image	Element Number	Element Type	Details Page
	Range of Values	Format	
	50	3-Byte-Time	 *
	Time	LONG,NOBG,ACTUAL,RDRQ,PIN	
	51	3-Byte-Date	 *
	Date	LONG,NOBG,ACTUAL,RDRQ,PIN	











2.8 Overview 4-Byte Elements

Image	Element Number	Element Type	Details Page
	Range of Values	Format	
	33	4-Byte-Float-Text-Button	 *
	IEEE 754	W,B-,B+,PF,STEPS,MIN,MAX,AL,AH,NOBG,REP,RDRQ,DC,PIN,*,INT,UINT	
	34	4-Byte-Float-Picture-Button	 *
	IEEE 754	W,PF,IMGSET,STEPS,MIN,MAX,AL,AH,NOBG,REP,RDRQ,DC,PIN,*,INT,UINT	
	35	4-Byte-Float-Slider	 *
	IEEE 754	W,PF,IMGSET,STEPS,MIN,MAX,AL,AH,NOBG,REP,RDRQ,DC,PIN,*,INT,UINT	
	44	4-Byte-Value-Pushbutton	 *
	IEEE 754	IMG,PRESS,RELEASE,LABEL,NOBG,JUMP,LOGIC,LOGICR,PIN	
	45	4-Byte-Float-Value-Pushbutton	 *
	IEEE 754	IMG,PRESS,RELEASE,LABEL,NOBG,JUMP,LOGIC,LOGICR,PIN	

2.9 Overview 14-Byte Elements

Image	Element Number	Element Type	Details Page
	Range of Values	Format	
	46	14-Byte-String-Pushbutton	 *
	14 Byte	MG,PRESS,RELEASE,LABEL,NOBG,JUMP,LOGIC,LOGICR,PIN	
	52	14-Byte-String	 *
	14 Byte	NOBG,TEXT,RDRQ	

2.10 Overview Scene Elements

Image	Element Number	Element Type	Details Page
	Range of Values	Format	
	55	Scene-Control-Recall-Save	 *
	0 .. 63	TO,N,IMAGES,LABELS,SCENES,MOD, NOBG,PIN,PPIN	
	56	Scene-Control-Recall-Only	 *
	0 .. 63	TO,N,IMAGES,LABELS,SCENES,MOD, NOBG,PIN	
	57	Scene-Control-Save-Only	 *
	0 .. 63	TO,N,IMAGES,LABELS,SCENES,MOD, NOBG,PIN	
	58	Internal-Scene	 *
		SELECT,NOBG,ONSTART,SCGRP,TRIGINV, IMG,PLAYONLY,PLAYSTOP	

Until the introduction of the software version v2.18 for Touch_IT were the following element-type formats.

Element No. 55

TO,N,MOD,Nx,Sx (x = 1..4),NOBG,PIN,PPIN

Element No. 56

N,MOD,Nx,Sx (x = 1..4),NOBG,PIN







Element No. 57

N,MOD,Nx,Sx (x = 1..4),NOBG,PIN

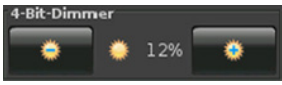
2.11 Overview RGB Elements

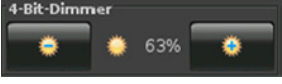
Image	Element Number	Element Type	Details Page
	Range of Values	Format	
	76	RGB-Dimmer-A	*
	4x (0 .. 255)	W,STEPS,IMGSET,B-,B+,NOBG,RGBH,RGBW, RDRQ,PIN	
	77	RGB-Dimmer-B	*
	4x (0 .. 255)	W,STEPS,IMGSET,B-,B+,NOBG,RGBH,RGBW, RDRQ,PIN	
	78	RGB-Dimmer-C	*
	4x (0 .. 255)	W,STEPS,IMGSET,B-,B+,NOBG,RGBH,RGBW, RDRQ,PIN	
	79	RGB-Dimmer-D	*
	4x (0 .. 255)	W,STEPS,IMGSET,B-,B+,NOBG,RGBH,RGBW, RDRQ,PIN	

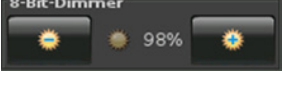







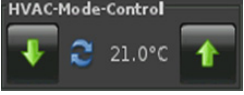

2.12 Overview Dimmer Elements

Image	Element Number	Element Type	Details Page
	Range of Values	Format	
	70	4-Bit-Dimmer-Start-Stop	 *
	0 .. 15	W,B-,B+,STEP,REP,TO,IMGSET,NOBG,RDRQ,PIN	
	71	4-Bit-Dimmer-Repeat	 *
	0 .. 15	W,B-,B+,STEP,REP,TO,IMGSET,NOBG,RDRQ,PIN	
	72	8-Bit-Dimmer-Repeat	 *
	0 .. 255	W,B-,B+,STEP,REP,TO,IMGSET,NOBG,RDRQ,PIN	

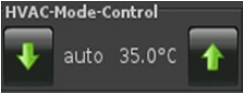



2.13 Overview Shutter-Blinds Elements

Image	Element Number	Element Type	Details Page
	Range of Values	Format	
	73	Shutter-Blinds-Control-A	*
	0/1	W,B-,B+,REP,TO,IMGSET,NOBG,RDRQ,PIN	
	74	Shutter-Blinds-Control-B	*
	0/1	W,B-,B+,REP,TO,IMGSET,NOBG,RDRQ,PIN	
	75	Shutter-Blinds-Control-C	*
	0/1	W,B-,B+,REP,TO,IMGSET,NOBG,RDRQ,PIN	



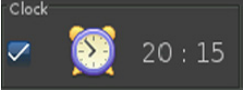

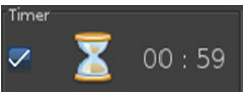



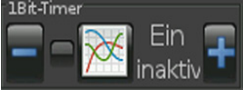

2.14 Overview HVAC Elements

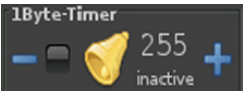
Image	Element Number	Element Type	Details Page
	Range of Values	Format	
	80	HVAC Setpoint-Control	 *
	-671088.64 .. 670760,96	W,TO,DC,STEP,T,MIN,MAX,NOBG,MASK,INTERN,RDRQ,PIN	
	81	HVAC Mode-Control	 *
	0 .. 4	W,NOBG,MASK,INTERN,FAN,TSET RDRQ,PIN	
	82	HVAC Mode-Control-Text	 *
	0 .. 4	W,NOBG,MASK,INTERN,TSET, RDRQ,PIN	
	83	HVAC-Fan-Control	 *
	0 .. 4	W,NOBG,INTERN,RDRQ	
	65	1-Byte-Timer-Profile HVAC	 *
	0 .. 255	W,OVRTO,NOBG,IMG,RDRQ,PIN,PPIN	

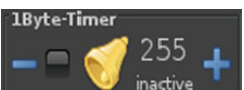

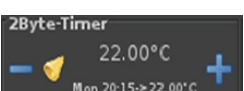

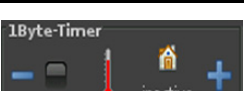

2.15 Overview Time / Date Elements

Image	Element Number	Element Type	Details Page
	Range of Values	Format	
	60	Alarmclock	 *
	0/1	W,ALTO,SILENT,NOBG,RDRQ,PIN,PPIN	
	61	Alarmtimer	 *
	0/1	W,ALTO,SILENT,NOBG,RDRQ,PIN,PPIN	

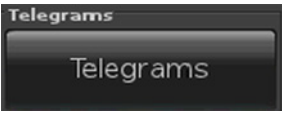
There are also different timer profiles.

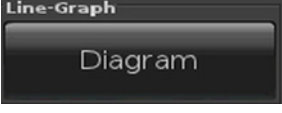
	62	1-Bit-Timer-Profile	 9
	63	1-Byte-Timer-Profile 0 .. 100%	 11
	64	1-Byte-Timer-Profile 0 .. 255	 11
	66	2-Byte-Float-Timer-Profile	 12
	65	1-Byte-Timer-Profile HVAC	 20

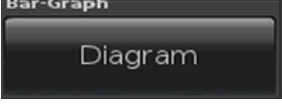
2.16 Overview Datalogging

Image	Element Number	Element Type	Details
	Range of Values	Format	Page
	95	Telegrams	 *
		OBJS,LABEL,PIN	
	96	Line-Graph	 *
		DGRM,LABEL,PIN	
	97	Bar-Graph	 *
		DGRM,LABEL,PIN	



Imprint

Editor: Arcus-EDS GmbH, Rigaer Str. 88, 10247 Berlin

Responsible for the contents: Hjalmar Hevers, Reinhard Pegelow

Reprinting in part or in whole is only permitted with the prior permission of Arcus-EDS GmbH.

All information is supplied without liability. Technical specifications and prices can be subject to change.

Liability

The choice of the devices and the assessment of their suitability for a specified purpose lie solely in the responsibility of the buyer. Arcus-EDS does not take any liability or warranty for their suitability. Product specifications in catalogues and data sheets do not represent the assurance of certain properties, but derive from experience values and measurements. A liability of Arcus-EDS for damages caused by incorrect operation/projecting or malfunction of devices is excluded. The operator/project developer has to make sure that incorrect operation, planning errors and malfunctions cannot cause subsequent damages.

Safety Regulations

Attention! Installation and mounting must be carried out by a qualified electrician.

The buyer/operator of the facility has to make sure that all relevant safety regulations, issued by VDE, TÜV and the responsible energy suppliers are respected. There is no warranty for defects and damages caused by improper use of the devices or by non-compliance with the operating manuals.

Warranty

We take over guarantees as required by law.

Please contact us if malfunctions occur. In this case, please send the device including a description of the error to the company's address named below.

Manufacturer



Registered Trademarks



The CE trademark is a curb market sign that exclusively directs to authorities and does not include any assurance of product properties.



Registered trademark of the Konnex Association.